

Data sheet | Item number: 750-552/025-000  
2-channel analog output; 0 ... 20 mA; Ext. Temperature

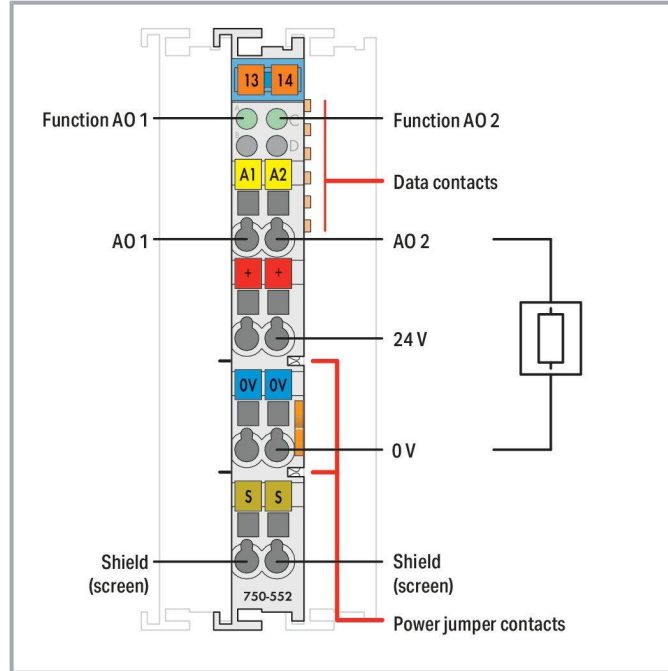

[www.wago.com/750-552/025-000](http://www.wago.com/750-552/025-000)

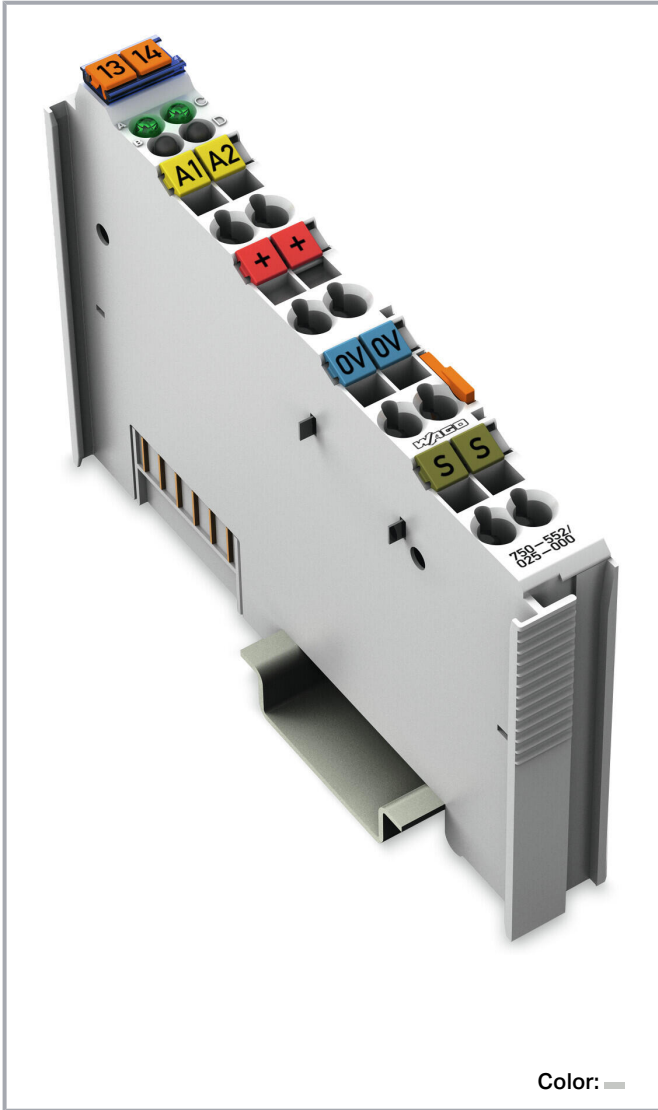

Subject to changes. Please also observe the further product documentation!

WAGO GmbH & Co. KG  
Hansastr. 27  
32423 Minden  
Phone: +49571 887-0 | Fax: +49571 887-169  
Email: [info.de@wago.com](mailto:info.de@wago.com) | Web: [www.wago.com](http://www.wago.com)

Do you have any questions about our products?  
We are always happy to take your call at +49 (571) 887-44222.

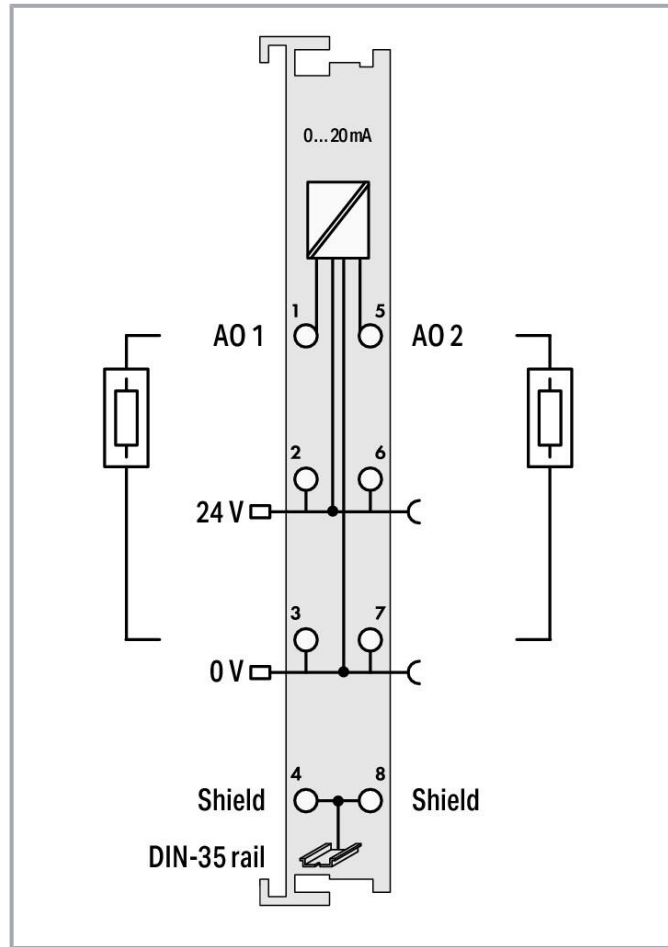
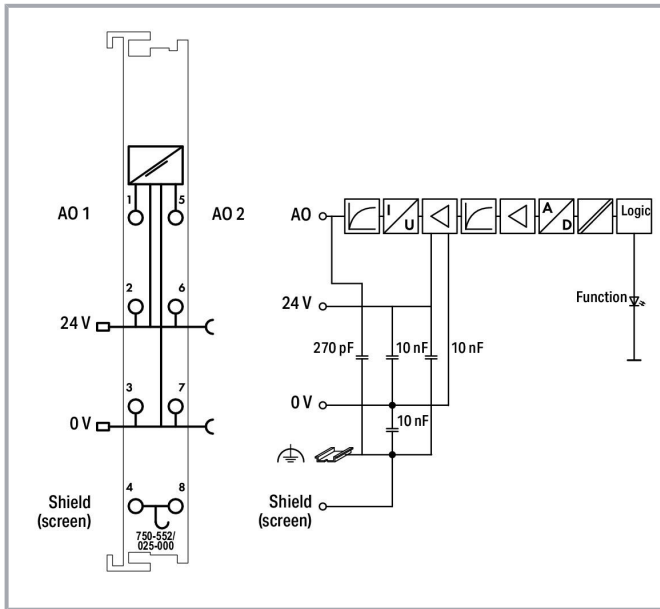

## Item description

This analog output module generates standard 0–20 mA signals.

The output signal is electrically isolated and transmitted with a resolution of 12 bits.

Power is derived from the field side.

## Data

### Technical data

Number of analog outputs	2
Total number of channels (module)	2
Signal type	Current
Signal type (current)	0 ... 20 mADC
Actuator connection	2 x (2-wire)

Subject to changes. Please also observe the further product documentation!



Resolution [bit]	12 bits
Data width	2 x 16-bit data; 2 x 8-bit control/status (optional)
Load impedance (current output)	≤ 600 Ω
Conversion time (typ.)	2 ms
Measurement error (reference temperature)	25 °C
Measurement error, deviation (max.) from the upper-range value	0.1 %
Temperature error (max.) of the upper-range value	0.01 %/K
Output error, deviation (max.) of the upper-range value	0.1 %
Temperature error (max.) of the output range value	0.01 %/K
Linearity	±10 µA
Supply voltage (system)	5 VDC; via data contacts
Current consumption (5 V system supply)	70 mA
Supply voltage (field)	24 VDC (-25 ... +30 %); via power jumper contacts (power supply via blade contact; transmission via spring contact)
Isolation	500 V system/field
Indicators	LED (A, C) green: Function AO 1, AO 2
Number of incoming power jumper contacts	2
Number of outgoing power jumper contacts	2

### Connection data

Connection technology: inputs/outputs	8 x CAGE CLAMP®
Connection type 1	Inputs/Outputs
Solid conductor	0.08 ... 2.5 mm <sup>2</sup> / 28 ... 14 AWG
Fine-stranded conductor	0.08 ... 2.5 mm <sup>2</sup> / 28 ... 14 AWG
Strip length	8 ... 9 mm / 0.31 ... 0.35 inches

### Physical data

Width	12 mm / 0.472 inches
Height	100 mm / 3.937 inches
Depth	69.8 mm / 2.748 inches
Depth from upper-edge of DIN-rail	62.6 mm / 2.465 inches

### Mechanical Data

Mounting type	DIN-35 rail
---------------	-------------

Subject to changes. Please also observe the further product documentation!



## Material Data

Color	light gray
Housing material	Polycarbonate; polyamide 6.6
Fire load	1.642 MJ
Weight	51 g
Conformity marking	CE

## Environmental requirements

Ambient temperature (operation)	-20 ... +60 °C
Ambient temperature (storage)	-40 ... +85 °C
Protection type	IP20
Pollution degree	2 per IEC 61131-2
Operating altitude	0 ... 2000 m / 0 ... 6562 ft
Mounting position	horizontal (standing/lying); vertical
Relative humidity (without condensation)	95 %
Relative humidity (with condensation)	Short-term condensation per Class 3K6/IEC EN 60721-3-3 and E-DIN 40046-721-3, accounting for a temperature range of -20 to +60 °C (except for wind-driven precipitation, water and ice formation)
Vibration resistance	4g per IEC 60068-2-6
Shock resistance	15g per IEC 60068-2-27
EMC immunity to interference	per EN 61000-6-2, marine applications
EMC emission of interference	per EN 61000-6-4, marine applications
Exposure to pollutants	Per IEC 60068-2-42 and IEC 60068-2-43
Permissible H <sub>2</sub> S contaminant concentration at a relative humidity 75 %	10 ppm
Permissible SO <sub>2</sub> contaminant concentration at a relative humidity 75 %	25 ppm

## Commercial data

Product Group	15 (I/O System)
eCl@ss 10.0	27-24-26-01
eCl@ss 9.0	27-24-26-01
ETIM 8.0	EC001596
ETIM 7.0	EC001596
PU (SPU)	1 pcs
Packaging type	box

Subject to changes. Please also observe the further product documentation!

WAGO GmbH & Co. KG  
 Hansastr. 27  
 32423 Minden  
 Phone: +49571 887-0 | Fax: +49571 887-169  
 Email: [info.de@wago.com](mailto:info.de@wago.com) | Web: [www.wago.com](http://www.wago.com)

Do you have any questions about our products?  
 We are always happy to take your call at +49 (571) 887-44222.



Country of origin	DE
GTIN	4045454670474
Customs tariff number	85389099990

## Environmental Product Compliance

CAS-No.	7439-92-1
REACH Candidate List Substance	Lead
RoHS Compliance Status	Compliant,With Exemption
RoHS Exemption	6(c) 7(a) 7(c)-I 7(c)-II
SCIP notification number (Austria)	ef5c0b3d-ecd9-4055-9273-4bab477189a3
SCIP notification number (Belgium)	198bed23-6259-401f-b2b2-d7ce2b8da816
SCIP notification number (Bulgaria)	4eef0b50-df0e-4f4d-8f6b-fa5d1b8a79ad
SCIP notification number (Czech Republic)	d27ab49e-be92-4e5b-a00d-e463d62dcb0d
SCIP notification number (Denmark)	b7b8e7c5-cbbb-469b-8dcf-48d009e3e35c
SCIP notification number (Finland)	70a8e378-0fe2-4ec1-aceb-62e2731d6b34
SCIP notification number (France)	ad653e23-5cce-437e-9bc6-9aca4a99e239
SCIP notification number (Germany)	1ec3d308-105f-4791-babe-2b1d50c0177e
SCIP notification number (Hungary)	21e1658e-eb0d-4e9c-bbdb-2df8210b66f8
SCIP notification number (Italy)	6e9793c4-1acf-4adf-bd28-7271d0417e36
SCIP notification number (Netherlands)	86396364-2c03-4020-b7ee-cb31958d405b
SCIP notification number (Poland)	967c7780-da9d-46ae-a9ec-1827849c1c07
SCIP notification number (Romania)	c1131a7f-5037-441d-b133-6ad3fbe2eb20
SCIP notification number (Sweden)	8aad0680-0033-4fc3-976b-4d80781027d3

## Approvals / Certificates

### General approvals

Logo	Approval	Additional Approval Text	Certificate name
	CCC CNEX	CNCA-C23-01	2020312310000213 (Ex ec IIC T4 Gc)
	KC National Radio Research Agency	Article 58-2, Clause 3	MSIP-REM-W43- AOM750
	UL Underwriters Laboratories Inc. (ORDINARY LOCATIONS)	UL 508	E175199 Sec.1

Subject to changes. Please also observe the further product documentation!



## Declarations of conformity and manufacturer's declarations

Logo	Approval	Additional Approval Text	Certificate name
	EU-Declaration of Conformity WAGO GmbH & Co. KG	-	-



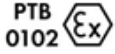

## Approvals for marine applications

Logo	Approval	Additional Approval Text	Certificate name
	ABS American Bureau of Shipping	-	22-2227356-PDA
	BSH Bundesamt fuer Seeschifffahrt und Hydrographie	-	1104
	DNV DNV Germany GmbH	DNV-CG-0339, Aug. 2021	TAA00001J4
	LR Lloyds Register	-	LR22194334TA
	PRS Polski Rejestr Statków	-	TE/2237 /880590/19

## Approvals for hazardous areas

Logo	Approval	Additional Approval Text	Certificate name
	ATEX TUEV Nord Cert GmbH	EN 60079-0	TUEV_14_ATEX_148929_X (II 3 G Ex ec IIC T4 Gc)
	CCC CNEX	CNCA-C23-01	2020312310000213 (Ex ec IIC T4 Gc)







Subject to changes. Please also observe the further product documentation!

	EAC Brjansker Zertifizierungsstelle	TP TC 012/2011	EAC RU C-DE.AM02.B.00163 /19 (2Ex nA IIC T4 Gc X)
	IECEX TUEV Nord Cert GmbH	IEC 60079-0	IECEX TUN 14.0035 X (Ex ec IIC T4 Gc)
	INMETRO TÜV Rheinland do Brasil Ltda.	IEC 60079-0	BR-Ex_TÜV 12.1297 X
	UKEx WAGO GmbH & Co. KG	EN 60079-0	UKCA_WAGO22UKEX003X_ec
	UL Underwriters Laboratories Inc. (HAZARDOUS LOCATIONS)	UL 121201	E198726 Sec.1

## Optional accessories

### Carrier rail

#### Mounting accessories

	<b>Item no.: 210-197</b> Steel carrier rail; 35 x 15 mm; 1.5 mm thick; 2 m long; slotted; similar to EN 60715; silver-colored	<a href="http://www.wago.com/210-197">www.wago.com/210-197</a>
	<b>Item no.: 210-198</b> Copper carrier rail; 35 x 15 mm; 2.3 mm thick; 2 m long; unslotted; according to EN 60715; copper-colored	<a href="http://www.wago.com/210-198">www.wago.com/210-198</a>
	<b>Item no.: 210-504</b> Steel carrier rail; 35 x 7.5 mm; 1 mm thick; 2 m long; slotted; galvanized; according to EN 60715; silver-colored	<a href="http://www.wago.com/210-504">www.wago.com/210-504</a>
	<b>Item no.: 210-505</b> Steel carrier rail; 35 x 7.5 mm; 1 mm thick; 2 m long; unslotted; galvanized; according to EN 60715; silver-colored	<a href="http://www.wago.com/210-505">www.wago.com/210-505</a>
	<b>Item no.: 210-506</b> Steel carrier rail; 35 x 15 mm; 1.5 mm thick; 2 m long; unslotted; galvanized; similar to EN 60715; silver-colored	<a href="http://www.wago.com/210-506">www.wago.com/210-506</a>
	<b>Item no.: 210-508</b> Steel carrier rail; 35 x 15 mm; 1.5 mm thick; 2 m long; slotted; galvanized; similar to EN 60715; silver-colored	<a href="http://www.wago.com/210-508">www.wago.com/210-508</a>

Subject to changes. Please also observe the further product documentation!

WAGO GmbH & Co. KG  
Hansastr. 27  
32423 Minden  
Phone: +49571 887-0 | Fax: +49571 887-169  
Email: [info.de@wago.com](mailto:info.de@wago.com) | Web: [www.wago.com](http://www.wago.com)

Do you have any questions about our products?  
We are always happy to take your call at +49 (571) 887-44222.



**Item no.: 210-113**

Steel carrier rail; 35 x 7.5 mm; 1 mm thick; 2 m long; unslotted; according to EN 60715; silver-colored

[www.wago.com/210-113](http://www.wago.com/210-113)



**Item no.: 210-118**

Steel carrier rail; 35 x 15 mm; 2.3 mm thick; 2 m long; unslotted; according to EN 60715; silver-colored

[www.wago.com/210-118](http://www.wago.com/210-118)



**Item no.: 210-112**

Steel carrier rail; 35 x 7.5 mm; 1 mm thick; 2 m long; slotted; according to EN 60715; "Hole width 25 mm; silver-colored

[www.wago.com/210-112](http://www.wago.com/210-112)



**Item no.: 210-114**

Steel carrier rail; 35 x 15 mm; 1.5 mm thick; 2 m long; unslotted; similar to EN 60715; silver-colored

[www.wago.com/210-114](http://www.wago.com/210-114)



**Item no.: 210-115**

Steel carrier rail; 35 x 7.5 mm; 1 mm thick; 2 m long; slotted; according to EN 60715; "Hole width 18 mm; silver-colored

[www.wago.com/210-115](http://www.wago.com/210-115)



**Item no.: 210-196**

Aluminum carrier rail; 35 x 8.2 mm; 1.6 mm thick; 2 m long; unslotted; similar to EN 60715; silver-colored

[www.wago.com/210-196](http://www.wago.com/210-196)

## Shield termination

### Shield clamping saddles



**Item no.: 790-116**

Shield clamping saddle; 19 mm wide; diameter of compatible conductor; 7 ... 16 mm

[www.wago.com/790-116](http://www.wago.com/790-116)



**Item no.: 790-124**

Shield clamping saddle; 27 mm wide; diameter of compatible conductor; 6 ... 24 mm

[www.wago.com/790-124](http://www.wago.com/790-124)



**Item no.: 790-108**

Shield clamping saddle; 11 mm wide; diameter of compatible conductor; 3 ... 8 mm

[www.wago.com/790-108](http://www.wago.com/790-108)



**Item no.: 790-140**

Shield clamping saddle; diameter of compatible conductor

[www.wago.com/790-140](http://www.wago.com/790-140)



**Item no.: 790-216**

Shield clamping saddle; 21.8 mm wide; 6 ... 16 mm

[www.wago.com/790-216](http://www.wago.com/790-216)



**Item no.: 790-220**

Shield clamping saddle; 30 mm wide; 6 ... 20 mm

[www.wago.com/790-220](http://www.wago.com/790-220)



**Item no.: 790-208**

Shield clamping saddle; 12.4 mm wide; 3 ... 8 mm

[www.wago.com/790-208](http://www.wago.com/790-208)

## System housing

### System enclosure



**Item no.: 850-814/002-000**

IP65 enclosure; Sheet steel (RAL 7035); WxHxD (200x120x200 mm); without flange plate

[www.wago.com/850-814/002-000](http://www.wago.com/850-814/002-000)



**Item no.: 850-815/002-000**

IP65 enclosure; Sheet steel (RAL 7035); WxHxD (300x120x200 mm); without flange plate

[www.wago.com/850-815/002-000](http://www.wago.com/850-815/002-000)

Subject to changes. Please also observe the further product documentation!

WAGO GmbH & Co. KG

Hansastr. 27

32423 Minden













Phone: +49571 887-0 | Fax: +49571 887-169

Email: [info.de@wago.com](mailto:info.de@wago.com) | Web: [www.wago.com](http://www.wago.com)

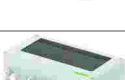
Do you have any questions about our products?

We are always happy to take your call at +49 (571) 887-44222.



	<b>Item no.: 850-816/002-000</b> IP65 enclosure; Sheet steel (RAL 7035); WxHxD (400x120x200 mm); without flange plate	<a href="http://www.wago.com/850-816/002-000">www.wago.com/850-816/002-000</a>
	<b>Item no.: 850-817/002-000</b> IP65 enclosure; Sheet steel (RAL 7035); WxHxD (600x120x200 mm); without flange plate	<a href="http://www.wago.com/850-817/002-000">www.wago.com/850-817/002-000</a>
	<b>Item no.: 850-825</b> IP65 enclosure; Aluminium (RAL 7032); WxHxD (160x100x160 mm); 9 x M12, 4 x M20	<a href="http://www.wago.com/850-825">www.wago.com/850-825</a>
	<b>Item no.: 850-826</b> IP65 enclosure; Aluminium (RAL 7032); WxHxD (240x100x160 mm); 4 x M20, 4 x M16, 14 x M12 cable grip	<a href="http://www.wago.com/850-826">www.wago.com/850-826</a>
	<b>Item no.: 850-827</b> IP65 enclosure; Aluminium (RAL 7032); WxHxD (320x100x160 mm); 4 x M20, 8 x M16, 17 x M12 cable grip	<a href="http://www.wago.com/850-827">www.wago.com/850-827</a>
	<b>Item no.: 850-827/002-000</b> IP65 enclosure; Aluminium (RAL 7035); WxHxD (320x100x160 mm); 4 x M20, 8 x M16, 17 x M12 cable grip	<a href="http://www.wago.com/850-827/002-000">www.wago.com/850-827/002-000</a>
	<b>Item no.: 850-826/002-000</b> IP65 enclosure; Aluminium (RAL 7035); WxHxD (240x100x160 mm); 4 x M20, 4 x M16, 14 x M12 cable grip	<a href="http://www.wago.com/850-826/002-000">www.wago.com/850-826/002-000</a>
	<b>Item no.: 850-828/002-000</b> IP65 enclosure; Aluminium (RAL 7035); WxHxD (480x100x160 mm); 4 x M20, 10 x M16, 35 x M12 cable grip	<a href="http://www.wago.com/850-828/002-000">www.wago.com/850-828/002-000</a>
	<b>Item no.: 850-828</b> IP65 enclosure; Aluminium (RAL 7032); WxHxD (480x100x160 mm); 4 x M20, 10 x M16, 35 x M12 cable grip	<a href="http://www.wago.com/850-828">www.wago.com/850-828</a>
	<b>Item no.: 850-834</b> IP65 enclosure; Polyester (RAL 7032); WxHxD (164x100x164 mm); 9 x M12, 4 x M20	<a href="http://www.wago.com/850-834">www.wago.com/850-834</a>
	<b>Item no.: 850-835</b> IP65 enclosure; Polyester (RAL 7032); WxHxD (244x100x164 mm); 4 x M20, 4 x M16, 14 x M12 cable grip	<a href="http://www.wago.com/850-835">www.wago.com/850-835</a>
	<b>Item no.: 850-836</b> IP65 enclosure; Polyester (RAL 7032); WxHxD (324x100x164 mm); 4 x M20, 8 x M16, 17 x M12 cable grip	<a href="http://www.wago.com/850-836">www.wago.com/850-836</a>

**Marking accessories**

Marker carrier		
	<b>Item no.: 750-103</b> Group marker carrier	<a href="http://www.wago.com/750-103">www.wago.com/750-103</a>
Marker		

Subject to changes. Please also observe the further product documentation!

**Item no.: 2009-145/000-006**

Mini-WSB Inline; for Smart Printer; 1700 pieces on roll; stretchable 5 - 5.2 mm; plain; snap-on type; blue [www.wago.com/2009-145/000-006](http://www.wago.com/2009-145/000-006)

**Item no.: 2009-145**

Mini-WSB Inline; for Smart Printer; 1700 pieces on roll; stretchable 5 - 5.2 mm; plain; snap-on type; white [www.wago.com/2009-145](http://www.wago.com/2009-145)

**Item no.: 2009-145/000-002**

Mini-WSB Inline; for Smart Printer; 1700 pieces on roll; stretchable 5 - 5.2 mm; plain; snap-on type; yellow [www.wago.com/2009-145/000-002](http://www.wago.com/2009-145/000-002)

**Item no.: 2009-145/000-007**

Mini-WSB Inline; for Smart Printer; 1700 pieces on roll; stretchable 5 - 5.2 mm; plain; snap-on type; gray [www.wago.com/2009-145/000-007](http://www.wago.com/2009-145/000-007)

**Item no.: 2009-145/000-005**

Mini-WSB Inline; for Smart Printer; 1700 pieces on roll; stretchable 5 - 5.2 mm; plain; snap-on type; red [www.wago.com/2009-145/000-005](http://www.wago.com/2009-145/000-005)

**Item no.: 2009-145/000-012**

Mini-WSB Inline; for Smart Printer; 1700 pieces on roll; stretchable 5 - 5.2 mm; plain; snap-on type; orange [www.wago.com/2009-145/000-012](http://www.wago.com/2009-145/000-012)

**Item no.: 2009-145/000-023**

Mini-WSB Inline; for Smart Printer; 1700 pieces on roll; stretchable 5 - 5.2 mm; plain; snap-on type; green [www.wago.com/2009-145/000-023](http://www.wago.com/2009-145/000-023)

**Item no.: 2009-145/000-024**

Mini-WSB Inline; for Smart Printer; 1700 pieces on roll; stretchable 5 - 5.2 mm; plain; snap-on type; violet [www.wago.com/2009-145/000-024](http://www.wago.com/2009-145/000-024)



**Item no.: 248-501/000-006**

Mini-WSB marking card; as card; not stretchable; plain; snap-on type; blue [www.wago.com/248-501/000-006](http://www.wago.com/248-501/000-006)



**Item no.: 248-501/000-007**

Mini-WSB marking card; as card; not stretchable; plain; snap-on type; gray [www.wago.com/248-501/000-007](http://www.wago.com/248-501/000-007)



**Item no.: 248-501/000-002**

Mini-WSB marking card; as card; not stretchable; plain; snap-on type; yellow [www.wago.com/248-501/000-002](http://www.wago.com/248-501/000-002)



**Item no.: 248-501/000-012**

Mini-WSB marking card; as card; not stretchable; plain; snap-on type; orange [www.wago.com/248-501/000-012](http://www.wago.com/248-501/000-012)

Subject to changes. Please also observe the further product documentation!

WAGO GmbH & Co. KG

Hansastr. 27

32423 Minden

Phone: +49571 887-0 | Fax: +49571 887-169

Email: [info.de@wago.com](mailto:info.de@wago.com) | Web: [www.wago.com](http://www.wago.com)

Do you have any questions about our products?

We are always happy to take your call at +49 (571) 887-44222.



**Item no.: 248-501**  
Mini-WSB marking card; as card; not stretchable; plain; snap-on type; white

[www.wago.com/248-501](http://www.wago.com/248-501)



**Item no.: 248-501/000-017**  
Mini-WSB marking card; as card; not stretchable; plain; snap-on type; light green

[www.wago.com/248-501/000-017](http://www.wago.com/248-501/000-017)



**Item no.: 248-501/000-005**  
Mini-WSB marking card; as card; not stretchable; plain; snap-on type; red

[www.wago.com/248-501/000-005](http://www.wago.com/248-501/000-005)



**Item no.: 248-501/000-024**  
Mini-WSB marking card; as card; not stretchable; plain; snap-on type; violet

[www.wago.com/248-501/000-024](http://www.wago.com/248-501/000-024)



**Item no.: 248-501/000-023**  
Mini-WSB marking card; as card; not stretchable; plain; snap-on type; green

[www.wago.com/248-501/000-023](http://www.wago.com/248-501/000-023)



**Item no.: 750-100**  
Marker card; as a DIN A4 sheet; plain

[www.wago.com/750-100](http://www.wago.com/750-100)

Group marker carrier



**Item no.: 750-106**  
Group marker carrier

[www.wago.com/750-106](http://www.wago.com/750-106)

## Supply module

Supply module



**Item no.: 750-602/025-000**  
Power Supply; 24 VDC; Ext. Temperature

[www.wago.com/750-602/025-000](http://www.wago.com/750-602/025-000)

## Downloads

### Documentation

#### Manual

System Manual WAGO I/O System 750/753 Decentralized Automation Technology	V 3.3.0 2023 May 4	pdf 8.8 MB	Download
Product Manual 2-channel, 0-20mA	V 1.2.0	pdf 2.1 MB	Download
System Manual Series 750/753		URL	Download

Subject to changes. Please also observe the further product documentation!

WAGO GmbH & Co. KG  
Hansastr. 27  
32423 Minden  
Phone: +49571 887-0 | Fax: +49571 887-169  
Email: [info.de@wago.com](mailto:info.de@wago.com) | Web: [www.wago.com](http://www.wago.com)

Do you have any questions about our products?  
We are always happy to take your call at +49 (571) 887-44222.



## Online HTML

**Bid Text**

750-552/025-000 docx - Datei	2019 Mar 5	docx 17.1 kB	Download
---------------------------------	------------	-----------------	----------

750-552/025-000 X81 - Datei	2019 Feb 19	xml 4.3 kB	Download
--------------------------------	-------------	---------------	----------

**Instruction Leaflet**

CCC Ex (Additional information) WAGO-I/O-SYSTEM *750-****/*	2023 Apr 26	pdf 163.6 kB	Download
--	-------------	-----------------	----------

**System Description**

Overview on WAGO-I/O-SYSTEM 750 approvals		pdf 789.0 kB	Download
---	--	-----------------	----------

750/753 Series I/O-System – General Product Information		pdf 1.7 MB	Download
---	--	---------------	----------

**Additional Information**

Disposal and Recycling Electrical and electronic equipment, Batteries, Packaging	V 1.1.0 2022 Aug 18	pdf 2.2 MB	Download
---	------------------------	---------------	----------

**CAD/CAE-Data****CAD data**

2D/3D Models 750-552/025-000		URL	Download
------------------------------	--	-----	----------

**CAE data**

EPLAN Data Portal 750-552/025-000		URL	Download
-----------------------------------	--	-----	----------

WSCAD Universe 750-552/025-000		URL	Download
--------------------------------	--	-----	----------

WSCAD Universe 750-552/025-000		URL	Download
--------------------------------	--	-----	----------

EPLAN Data Portal 750-552/025-000		URL	Download
-----------------------------------	--	-----	----------

ZUKEN Portal 750-552/025-000		URL	Download
------------------------------	--	-----	----------

Subject to changes. Please also observe the further product documentation!



## Device Files

### Device Driver

WAGO USB Service Kabel Treiber / Serie 750 und 857	6.5.3.0 2014 Sep 10	zip 4.8 MB	Download
--	------------------------	---------------	----------

---

## Environmental Product Compliance

### Compliance Search

Environmental Product Compliance 750-552/025-000 2-channel analog output; 0 ... 20 mA; Ext. Temperature	URL	Download
--	-----	----------

---

## Installation Notes

## Product family

**WAGO I/O System 750/753**  
[Show all products from the family](#)

Subject to changes. Please also observe the further product documentation!