

# FS-2506L-S

## SHOCK ABSORBER - ADJUSTABLE

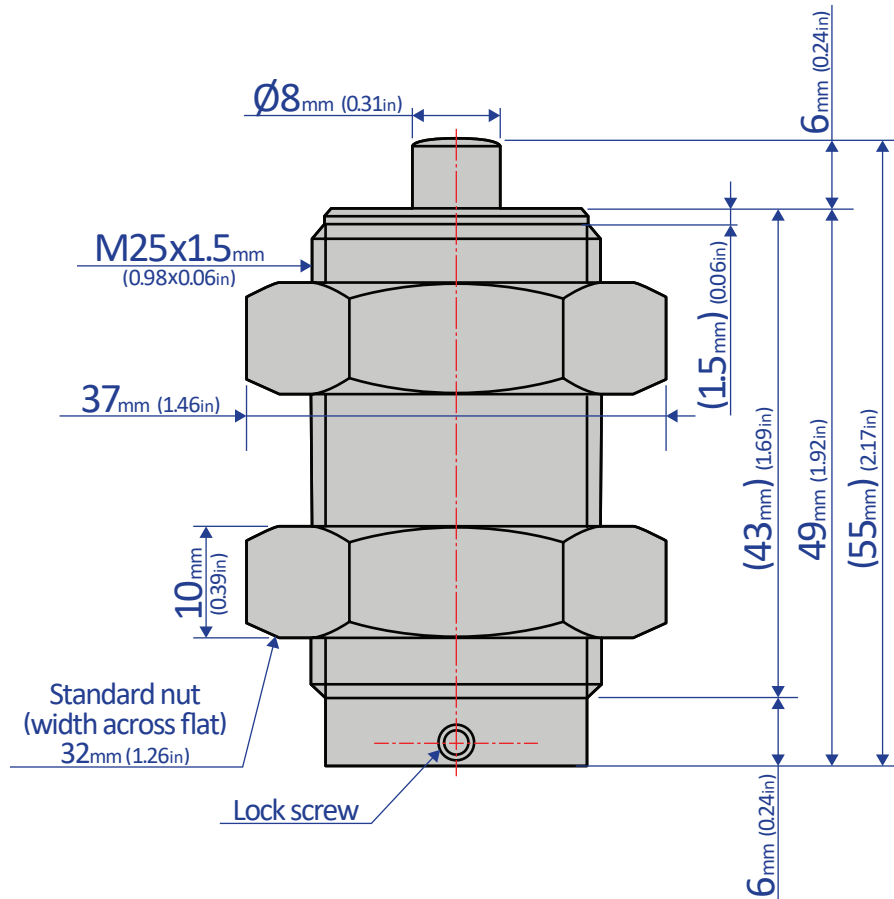

Turn the slotted-driver groove to desired position

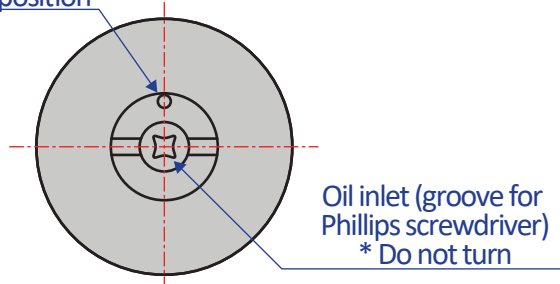

**Bansbach**  
*easylift*<sup>®</sup>

50 West Drive • Melbourne, Florida 32904  
(321) 253-1999 • [www.easylift.com](http://www.easylift.com) • [www.damper.net](http://www.damper.net)