



# **INVENTEK SYSTEMS**

**ISM43340-M4G-L44**

**eS-WiFi™**

**(embedded Serial-to-WiFi)**

**802.11 a/b/g/n + Bluetooth 4.0 + MCU + Certified Antenna  
Module Data Sheet**

## Table of Contents

1	GENERAL DESCRIPTION .....	4
2	PART NUMBER DETAIL DESCRIPTION .....	6
2.1	Ordering Information .....	6
3	CERTIFICATIONS .....	7
3.1	Limitations .....	7
3.2	Regulatory Compliance .....	7
3.3	FCC and IC User’s Manual Statements: .....	8
4	COMPLEMENTARY DOCUMENTATION .....	11
4.1	Inventek Systems .....	11
5	SPECIFICATIONS .....	11
5.1	eS-WiFi Module Architecture .....	11
5.2	External Antenna Connections .....	12
5.3	Mechanical Specifications .....	12
5.4	Environmental Specifications .....	12
6	HARDWARE ELECTRICAL SPECIFICATIONS .....	13
6.1	Absolute Maximum Ratings .....	13
6.2	Recommended Operating Ratings .....	13
6.3	Power Consumption .....	13
7	PIN DESCRIPTION .....	14
7.1	Reserved Pins .....	15
7.2	+10 Pins .....	15
8	FIRMWARE UPGRADES DURING DEVELOPMENT .....	16
9	SERIAL HOST INTERFACES AVAILABLE .....	16
9.1	UART .....	16
9.1.1	Data Mode .....	16
9.1.2	Flow Control .....	16
9.1.3	Supported Baud Rates .....	16
9.1.4	Default Serial Configuration .....	16
9.1.5	SPI (Serial Peripheral Interface Bus) .....	17
9.1.6	SPI Communication Overview: .....	17
9.1.7	SPI Command Phase: .....	18
9.1.8	SPI Endian Example: .....	19
9.1.9	SPI Data Phase: .....	20
9.1.10	SPI Asynchronous Messages: .....	20
9.1.11	SPI AC Characteristics: .....	21
9.2	USB .....	21
9.3	GPIO .....	21
9.4	ADC’s .....	21
10	RF SPECIFICATION .....	22
10.1	Wi-Fi Specification .....	22
10.1.1	2.4 GHz Band .....	22
10.1.2	5 GHz Band .....	23

10.2	BT/BLE Specification.....	24
10.2.1	FEATURES: .....	24
10.2.2	PARAMETERS:.....	24
11	ANTENNA .....	25
11.1	External Antenna .....	25
11.2	Mechanical Specifications .....	26
12	ON BOARD PROCESSOR.....	27
13	ISM43340-M4G-L44 FOOTPRINT .....	28
13.1	ISM43340-M4G-L44-10xx eS-WiFi Module’s Dimensions top view (mm).....	28
13.2	ISM43340-M4G-L44-xxx Module’s Dimensions top view (mm) .....	28
14	PRODUCT COMPLIANCE CONSIDERATIONS .....	29
15	REFLOW PROFILE .....	29
16	PACKING INFORMATION.....	30
16.1	MSL Level / Storage Condition.....	30
16.2	Device baking requirements prior to assembly.....	31
17	REVISION CONTROL.....	31
18	CONTACT INFORMATION.....	32

**Inventek Systems LLC.**

**Model: ISM4334x-M4G-L44**

**FCC ID: O7P-341**

**IC: 10147A-341**

THIS DEVICE COMPLIES WITH PART 15 OF THE FCC RULES.  
OPERATION IS SUBJECT TO THE FOLLOWING TWO CONDITIONS.

- (1) THIS DEVICE MAY NOT CAUSE HARMFUL INTERFERENCE, AND
- (2) THIS DEVICE MUST ACCEPT ANY INTERFERENCE RECEIVED,  
INCLUDING INTERFERENCE THAT MAY CAUSE UNDESIRE  
OPERATION.

# 1 GENERAL DESCRIPTION

The Inventek ISM43340-M4G-L44 is an embedded Serial WiFi (**eS-WiFi**), wireless internet connectivity module that operates in the 2.4 & 5.0 GHz spectrum. The **eS-WiFi** module's hardware consists of an ARM Cortex M4 host processor, Cypress CYW43340 Dual-Band (2.4 GHz / 5 GHz) 802.11 a/b/g/n MAC/Baseband/Radio with Integrated Bluetooth 4.0. The ISM43340 **eS-WiFi** module is compatible with the Bluetooth Low Energy operating mode, which provides a dramatic reduction in the power consumption of the Bluetooth radio and baseband. The primary application for this mode is to provide support for low data rate devices, such as sensors and remote controls. An independent, high-speed UART is provided for the Bluetooth host interface

The **eS-WiFi** module has two antenna options, an on board dual band chip 2.4 & 5 GHz or a U.FL external 2.4 & 5 GHz antenna. The ISM43340 **eS-WiFi** module includes integrated power amplifiers, LNAs and T/R switches for the 2.4 GHz and 5 GHz WLAN bands, greatly reducing the external part count, PCB footprint, and cost of the solution.

The **eS-WiFi** module provides UART and SPI interfaces enabling connection to an embedded design. The **eS-WiFi** module requires no operating system and has a completely integrated TCP/IP Stack. The **eS-WiFi** module hardware can be used with Inventek's **IWIN** (Inventek Wireless Interoperability Network), AT Command set or with Cypress' WICED™ SDK3.1.2 or later.

Inventek's **IWIN**, AT command set, allows you to quickly establish connectivity for your wireless product, minimizing development time, testing routines and certification. The low cost, small foot print (14.5 mm x 34 mm) and ease of design-in make it ideal for a range of embedded applications.

## **Hardware Features:**

- Uses CYW43340 Cypress Leading Edge Radio Device.
- Includes STM32F405 ST Cortex M4 Microcontroller.
- 2.4 GHz and 5.0 GHz Bands.
- Bluetooth 4.0 including BLE Support.
- 2.4 & 5 GHz Chip Antenna on the **eS-WiFi** module (FCC/CE/IE certified).
- U.FL Connector for external 2.4 GHz & 5GHz Antenna (FCC/CE/IE certified).
- Configurable using Inventek's proprietary **IWIN** AT commands.
- Host interface: UART, SPI.
- 44-Pin and L44+10 Land Grid Array Footprint (7 GPIO for **IWIN** & 17 GPIO for WICED).
- 14.7mm x 34mm x 2.5 mm
- 5 GPIO's for SPI or ADC (SPI uses ADC Pins)
- Input Voltage: 3.3 V
- Low power operation with built-in low power modes.
- Proven Interoperability ... Connects with other a/b/g/n Access Points in the Wireless LAN.

***Firmware Features:***

- **IWIN-** AT command Set/ API's for any External Host
- Hardware Supported by Cypress WICED™ SDK 3.5.2 or later.
- Secure Wi-Fi authentication WEP-128, WPA-PSK (TKIP), WPA2-PSK.
- WiFi-BT bridging based on WICED™ SDK.
- Fully contained TCP/IP stack minimizing host CPU requirements.
- Network features: ICMP (Ping), ARP, DHCP, TCP, UDP.
- SSL3.0/TLS1.0/1.1/1.2 Security Library.
- Cloud Agents: AWS IoT, Arrayent, and Lowes Iris...
- Configuration Webpage for Connecting to Networks
- Support for Web Service API for iOS and Android that allows easy connection with no web browser required.
- AP Auto-Channel Select Algorithm in Congested/Overlapping Signal Environments
- Wi-Fi Protected Set-up (WPS) Support
- SoftAP and Client Modes – Simultaneous Support
- Support for up to Four Simultaneous Sockets
- Supports up to 3 Connected Clients in SoftAP Mode
- Domain Name System –DNS Support
- mDNS Multicast Support
- Bootloader for the **eS-WiFi** Module Updates

***Typical Applications:***

- PDA, Pocket PC, computing devices.
- Building automation and smart energy control.
- Industrial sensing and remote equipment monitoring.
- Warehousing, logistics and freight management.
- PC and gaming peripherals.
- Printers, scanners, alarm and video systems.
- Medical applications including patient monitoring and remote diagnostics.

## 2 PART NUMBER DETAIL DESCRIPTION

### 2.1 Ordering Information

ISM43340-M4G-L44-X X X X-I.I.I-C.Z.Z.Z.Z

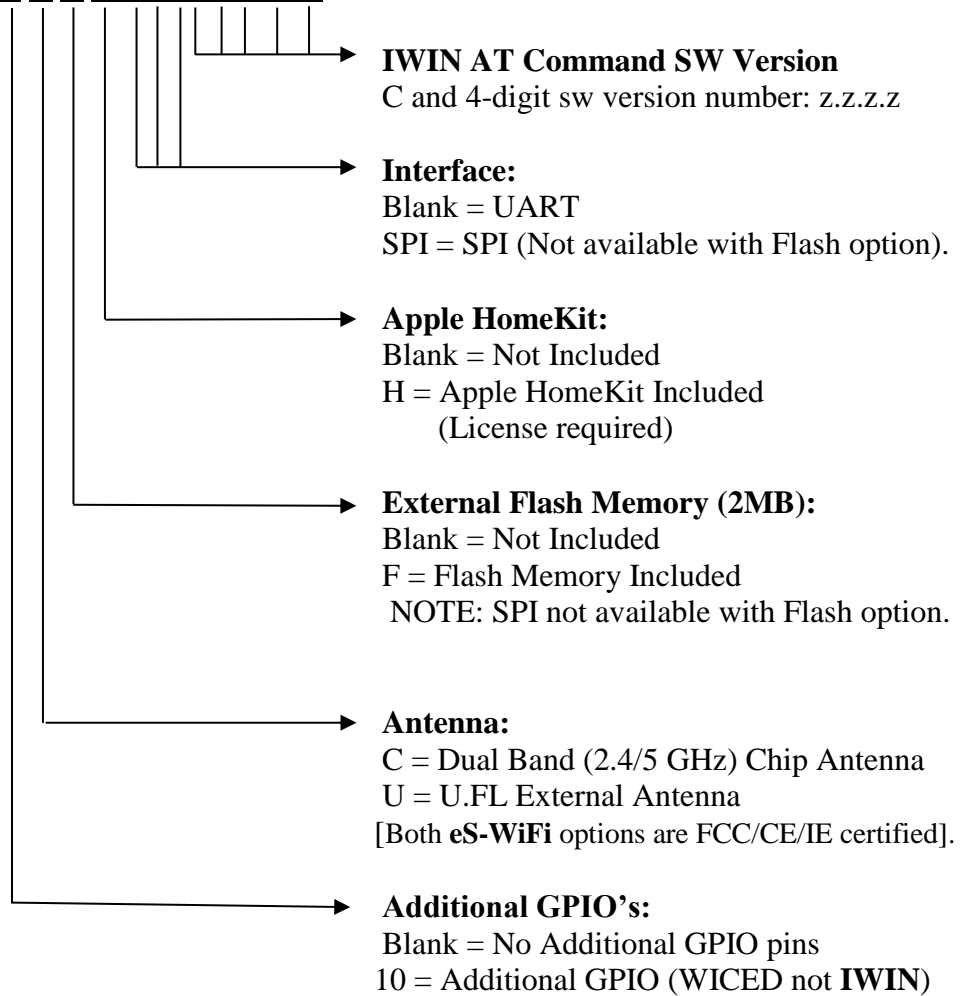

Evaluation Boards			
<b>eS-WiFi-43340</b> EVB	Inventek <b>eS-WiFi</b> (embedded <b>Serial Wi-Fi</b> ), Evaluation Board, USB cable, with ISM43340-M4G-L44 module.	<ul style="list-style-type: none"> <li>USB Com. Port (UART) &amp; JTAG</li> </ul>	ISM43340-M4G-L44 Evaluation Board
<b>ISMART-43340</b> EVB	Inventek <b>ISMART</b> (Inventek Systems <b>Module AR</b> duino <b>Test</b> ), EVB with ISM43340-M4G-L44 module.		

## 3 CERTIFICATIONS

### 3.1 Limitations

Inventek Systems products are not authorized for use in safety-critical applications (such as life support) where a failure of the Inventek Systems product would reasonably be expected to cause severe personal injury or death.

### 3.2 Regulatory Compliance

CE



Regulator	Status
FCC	O7P-341
IC	10147A-341
RoHS	Compliant

### 3.3 FCC and IC User's Manual Statements:

#### OEM INSTRUCTIONS:

This **eS-WiFi** module is limited to OEM installation only.

OEM integrators must ensure that the end-user has no manual instructions to remove or install the **eS-WiFi** module. OEM's must comply with FCC marking regulation part 15 declaration of conformity (Section 2.925(e)).

This **eS-WiFi** module is to be installed only in mobile or fixed applications (Please refer to FCC CFR 47 Part 2.1091(b) for a definition of mobile and fixed devices).

Separate approval is required for all other operating configurations, including portable configurations with respect to FCC CFR 47 Part 2.1093, and different antenna configurations.

The antennas used with this **eS-WiFi** module must be installed to provide a separation distance of at least 20cm from all persons, and must not be co-located or transmit simultaneously with any other antenna or transmitter, except in accordance with FCC multi transmitter product procedures.

The ISM43340 **eS-WiFi** Modules has been designed to operate with the following antennas and gains. Use with other antenna types or with these antenna types at higher gains is strictly prohibited.

Manufacturer	Type of Antenna	Model	Gain dBi	Type of Connector
Inventek	U.FL port Antenna	W2.4-5P-U	2.6 (@ 2.4 GHz) 3.3 (@ 5 GHz)	U.FL
Inventek	Chip Antenna	AA077	1.4 (@ 2.4 GHz) 2.3 (@ 5 GHz)	Chip



**FCC Notice-**

*This device complies with Part 15 of the FCC rules. Operation is subject to the following two conditions: (1) this device may not cause harmful interference, and (2) this device must accept any interference received, including interference that may cause undesired operation.*

Note: This equipment has been tested and found to comply with the limits for a Class B digital device, pursuant to part 15 of the FCC Rules. These limits are designed to provide reasonable protection against harmful interference in a residential installation. This equipment generates uses and can radiate radio frequency energy and, if not installed and used in accordance with the instructions, may cause harmful interference to radio communications.

However, there is no guarantee that interference will not occur in a particular installation. If this equipment does cause harmful interference to radio or television reception, which can be determined by turning the equipment off and on, the user is encouraged to try to correct the interference by one or more of the following measures:

- Reorient or relocate the receiving antenna.*
- Increase the separation between the equipment and receiver.*
- Connect the equipment into an outlet on a circuit different from that to which the receiver is connected.*
- Consult the dealer or an experienced radio/TV technician for help.*

Warning: changes or modifications not expressly approved by the party responsible for compliance could void the user's authority to operate this equipment.

A clearly visible label is required on the outside of the user's (OEM) enclosure stat the following text:

Contains FCC ID: O7P-341

Contains IC: 10147A-341

This transmitter module has been certified for FCC Part 15 operation; when installed in a host device, the host manufacturer is responsible for making sure that the host device with the transmitter installed continues to be compliant with Part 15B unintentional radiator requirements

---

**Industry Canada User's Manual Statements:****IC RSS-210/RSS-Gen Notices-**

Operation is subject to the following two conditions: (1) this device may not cause interference, and (2) this device must accept any interference, including interference that may cause undesired operation of this device.

L'opération est soumise aux deux conditions suivantes: (1) cet appareil ne peut pas provoquer d'interférences et (2) cet appareil doit accepter toute interférence, y compris les interférences qui peuvent causer un mauvais fonctionnement de l'appareil.

Under Industry Canada regulations, this radio transmitter may only operate using an antenna of a type and maximum (or lesser) gain approved for the transmitter by Industry Canada. To reduce potential radio interference to other users, the antenna type and its gain should be so chosen that the equivalent isotropically radiated power (e.i.r.p.) is not more than that necessary for successful communication.

Sous la réglementation d'Industrie Canada, ce transmetteur radio ne peut fonctionner en utilisant une antenne d'un type et un maximum (ou moins) gain approuvées pour l'émetteur par Industrie Canada. Pour réduire le risque d'interférence aux autres utilisateurs, le type d'antenne et son gain doivent être choisis de manière que la puissance isotrope rayonnée équivalente (PIRE) ne dépasse pas ce qui est nécessaire pour une communication réussie.

The radio transmitter has been approved by Industry Canada to operate with the antenna types listed above with the maximum permissible gain and required antenna impedance for each antenna type indicated. Antenna types not included in this list having a gain greater than the maximum gain indicated for that type, are strictly prohibited for use with this device.

Cet émetteur de radio a été approuvé par Industrie Canada pour fonctionner avec les types d'antennes énumérées ci-dessus avec le gain maximal admissible et impédance d'antenne requise pour chaque type d'antenne indiqué. Types d'antennes ne figurant pas dans cette liste, ayant un gain supérieur au gain maximum indiqué pour ce type, sont strictement interdites pour l'utilisation avec cet appareil.

## 4 COMPLEMENTARY DOCUMENTATION

### 4.1 Inventek Systems

- Evaluation Boards Documentation: <http://www.inventeksys.com/products-page/wifi-modules/ism43341-m4g-l44-cu-embedded-serial-to-wifi-ble-nfc-module/>
  - ISM43340-M4G-L44 Data Sheet
  - eS-WiFi EVB Quick Start Guide
  - eS-WiFi EVB User's Manual
  - eS-WiFi EVB PC Demo software (includes EVB Drivers and Firmware)
  - eS-WiFi EVB Demo Software Help
  - ISMART Arduino EVB option.
- IWIN AT Command Set Documentation
  - IWIN AT Command Set User's Manual
  - IWIN AT Command Set Quick Reference Guide
  - IWIN AT Command Sample Scripts Firmware
- OrCAD Schematic Symbol
- PADS Land Pattern
- FCC Test Report

## 5 SPECIFICATIONS

### 5.1 eS-WiFi Module Architecture

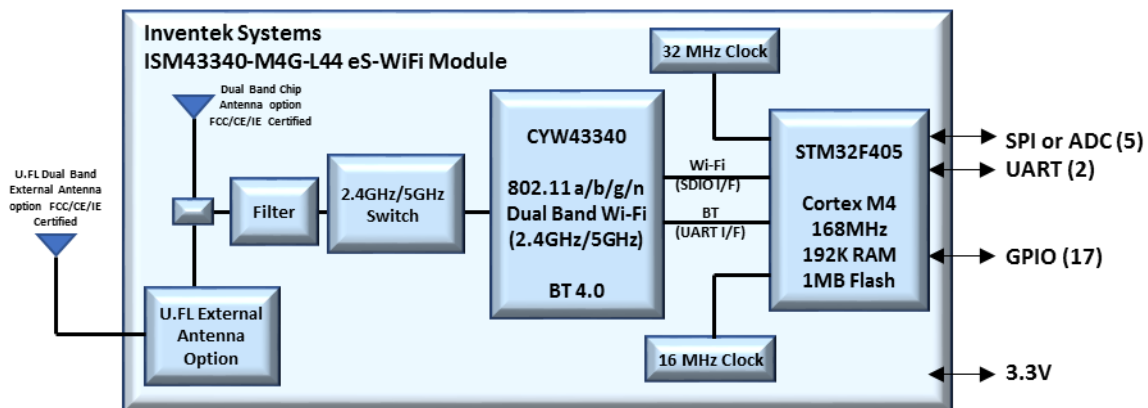

Inventek's ISM43340-M4G-L44 General Block Diagram

**Note:** () Indicates number of pins

## 5.2 External Antenna Connections

ISM43340-M4G-L44-CU **eS-WiFi** module is designed for use with an external antenna via a connection using the U.FL connector.

Item	Description
Connector	U.FL series
Manufacturer	I-PEX Co., Ltd.
Part No.	20279-001E-01
Height	1.25 mm
Width	2 mm
DC	3.0 – 5.0 V

**On-Board Antenna Connector**

## 5.3 Mechanical Specifications

The Physical dimensions of this **eS-WiFi** Module are as follow:

Items	Description
	<b>ISM43340-M4G-L44-CU</b>
Length	34.22 mm (-/+0.5 mm)
Width	14.70 mm (-/+0.5 mm)
Height	2.5 ± 0.2 mm
Package	44 pin LGA (w/ +10 pin option)

## 5.4 Environmental Specifications

Item	Description
Operating temperature range	-40 deg. C to +85 deg. C
Storage temperature range	-40 deg. C to +85 deg. C
Humidity	95% max non-condensing

Note 1: The ISM43340-M4G supports a functional operating range of -40°C to +85°C. However the optimal RF performance specified in this data sheet is only guaranteed for temperatures from -10°C to +65°C

## 6 HARDWARE ELECTRICAL SPECIFICATIONS

### 6.1 Absolute Maximum Ratings

Symbol	Description	Min	Max	Unit
VDD	Input supply Voltage	-0.4	3.7	V
VBAT	Battery Backup	-0.4	3.6	V

### 6.2 Recommended Operating Ratings

Symbol	Min.	Typ.	Max.	Unit.
VDD	3.0	3.3	3.6	V
VBAT	3.0	3.3	3.6	V

**Note:**

- If a separate VBAT supply is not being used, then ties VBAT and VDD together.
- Please place a 10-15uF Bulk CAP as close to the module as possible to VDD\_3V3.

### 6.3 Power Consumption

Mode	Description	Typical	Max	Unit
Radio Off	ST Powered	27	-	mA
Radio On	Not Connected to Network	34	-	mA
Radio On	Connected to Network	88	340 <sup>[1]</sup>	mA
Power Save Mode	Connected to Network	38	-	mA
Radio On	BT Smartbridge	90	340 <sup>[1]</sup>	mA
Absolute Max	Worst Case	-	560 <sup>[2]</sup>	mA

**Note:**

<sup>[1]</sup> Wi-Fi On, and connected to a network: Max 120 mA (340 mA burst of less than 5 ms)

<sup>[2]</sup> Worst case power consumption represents active Bluetooth and Wi-Fi

## 7 PIN DESCRIPTION

Pin No.	Type	Pin Definition	Descriptions
1	G	GND	Ground
2	I	VDD	3.3V
3	G	GND	Ground
4	I/O	TMS	JTAG
5	I/O	TCK	JTAG
6	I/O	TDI	JTAG
7	I/O	TD0	JTAG
8	I/O	TDRSTN	JTAG
9	I/O	ADC 4 / SPI_MOSI	ADC Input Pins or SPI Host Interface (Refer to SPI Section 0)
10	I/O	ADC 3 / SPI_MISO	
11	I/O	ADC 2 / SPI_SCK	
12	I/O	ADC 1 / SPI_SSN	
13	I/O	ADC 0 (I)/ DATARDY (O)	
14	I	VDD	3.3V
15	I	VBAT	3.3V
16	I	Wakeup	Host Wakeup
17	G	GND	Ground
18	I	DP	USB Data Plus
19	I/O	DM	USB Data Minus
20	G	GND	Ground
21	I/O	RX	UART Receive (Refer to section 9.1 )
22	I/O	TX	UART Transmit (Refer to section 9.1 )
23	I/O	GPIO 0	General Purpose Interface Pins
24	I/O	GPIO 1	
25	I/O	GPIO 2	
26	I/O	GPIO 3	
27	I/O	GPIO 4	
28	I	DNC	No connect for ISM43340
29	I	DNC	No connect for ISM43340
30	I/O	RES	GPIO, see section 7.1
31	I/O	RES	GPIO, see section 7.1

Pin No.	Type	Pin Definition	Descriptions
32	I/O	RES	GPIO, see section 7.1
33	I	BOOT 0	Enable On-Board Microcontroller Boot Loader (See STM32F405 BOOT0 specification)
34	I	RSTN	Reset (See STM32F405 NRST specification )
35	G	GND	Ground
36	G	GND	Ground
37	G	GND	Ground
38	G	GND	Ground
39	G	GND	Ground
40	G	GND	Ground
41	G	GND	Ground
42	G	GND	Ground
43	G	GND	Ground
44	G	GND	Ground

## 7.1 Reserved Pins

Pins currently available for designs using the WICED-SDK only.

Pin No.	Type	Pin Definition	Descriptions
30	I/O	GPIO15	Alternate Function: STM32F405, PB15
31	I/O	GPIO14	Alternate Function: STM32F405, PB14
32	I/O	GPIO13	Alternate Function: STM32F405, PB13

## 7.2 +10 Pins

Pins currently available for designs using the WICED-SDK only.

Pin No.	Type	Pin Definition	Descriptions
45	I/O	GPIOA	Alternate Function: STM32F405, PA2
46	I/O	GPIOB	Alternate Function: STM32F405, PA1
47	I/O	GPIOC	Alternate Function: STM32F405, PB10
48	I/O	GPIOD	Alternate Function: STM32F405, PC3
49	I/O	GPIOE	Alternate Function: STM32F405, PB11
50	I/O	GPIOF	Alternate Function: STM32F405, PB12
51	I/O	GPIOG	Alternate Function: STM32F405, PE11
52	I/O	GPIOH	Alternate Function: STM32F405, PE12
53	I/O	GPIOJ	Alternate Function: STM32F405, PE13
54	I/O	GPIOK	Alternate Function: STM32F405, PE14

## 8 FIRMWARE UPGRADES DURING DEVELOPMENT

We recommend using a JTAG 10 pin header or directly connecting to the JTAG pins on the **eS-WiFi** module for updating. Use the ST-Link to flash the ST micro.

Below are links to the ST-Link and JTAG header at Digikey:

STLink:

<http://www.digikey.com/product-detail/en/ST-LINK%2FV2/497-10484-ND/2214535>

The 10 to 20 pin JTAG adapter is Digi-Key PN 726-1193-ND:

<http://www.digikey.com/product-detail/en/MDL-ADA2/726-1193-ND/1986451>

\*JTAG Firmware Update Note can be found at [www.inventeksys.com](http://www.inventeksys.com)

## 9 SERIAL HOST INTERFACES AVAILABLE

UART, and SPI host interfaces are supported and unique firmware is required for each interface.

### 9.1 UART

A universal asynchronous receiver / transmitter (UART) with 3.3v logic levels is available.

#### 9.1.1 Data Mode

When the **eS-WiFi** module is interfaced serially, the serial interface needs to be configured for 8 bit data, no parity, and one stop bit -- (8-n-1).

#### 9.1.2 Flow Control

The **eS-WiFi** module and WICED do not require or support Flow Control, so Flow Control should not be implemented.

#### 9.1.3 Supported Baud Rates

The **eS-WiFi** module uses USART1 (PA9 and PA10 of the STM32F405) and the following serial baud rates are supported: 1200, 2400, 4800, 9600, 19200, 38400, 57600, 115200, 230400, 460800, 921600, 1152000, 1382400, 1612800, 1834200, 2073600, 2304000, 2764800, 3686400, 3910800. Please note that higher baud read does not always correlate to higher throughput.

#### 9.1.4 Default Serial Configuration

The **eS-WiFi** module is shipped with the default serial configuration of 115200 baud, 8 data bits, no parity, and 1 stop bits.



### 9.1.5 SPI (Serial Peripheral Interface Bus)

The **eS-WiFi** module supports SPI (Contact Inventek for specific firmware.)

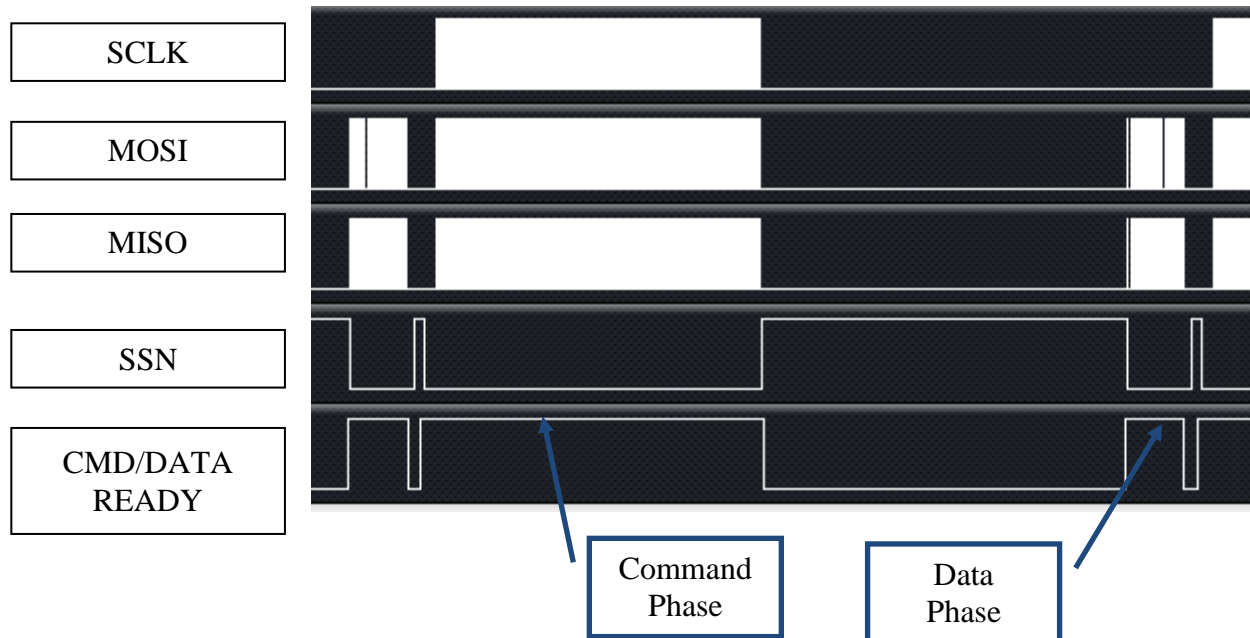

#### SPI Slave Interface:

Clock rate: 20MHz max.  
Width: 16-bit  
Mode: 0  
Endian: Little

Note: All commands to the **eS-WiFi** module must be post-padded with 0x0A (Line Feed) to an even number of bytes.

All data from **eS-WiFi** module will be post-padded with 0x15(NAK) to an even number of bytes.

### 9.1.6 SPI Communication Overview:

With the exception of initial cursor, all communication with the **eS-WiFi** module happens synchronously. In other words, the SPI Master must always poll for every asynchronous event.

A typical command flow is provided flow. This is an example using the Direct Connect Soft AP with a TCP communication server.

SPI Master	SPI Slave (eS-WiFi)	Description
	“\r\n> “	Prompt
“AS=0,ABC\r\x0A”	“\r\n\r\nOK\r\n> ”	Set Access Point SSID
“AD\r\x0A”	“\r\n\r\nOK\r\n> ”	Start AP - Direct Mode
“P1=0\r\x0A”	“\r\n\r\nOK\r\n> ”	Set TCP Protocol
“P4=2000\r”	“\r\n\r\nOK\r\n> ”	Set TCP Port
“P5=1\r\x0A”	“\r\n\r\nOK\r\n> ”	Start TCP COMM Server
“MR\r\x0A”	“\r\n[SOMA]...[EOMA]\r\nOK\r\n> ”	Read Messages

Note: [SOMA] - Start of Message Asynchronous, [EOMA] - End Of Message Asynchronous

The SPI communication is always 16-bit and can be sustained up to 20MHz. The **eS-WiFi** module after power up or reset will raise CMD/DATA READY pin to signal that the first Data Phase has started. In this mode, the SPI Host must fetch the cursor. As provided by the example above, this is the only time host needs fetch data from slave without issuing a command.

The Host will initiate a SPI cycle (lower SSN) and clock out 0x0A (Line Feed) until the CMD/DATA READY pin lowers signaling the end of the Data Phase. The data received will be 0x0d (CR) 0x0A (LF) 0x3E (>) 0x20 (SP).

The next rising edge of the CMD/DATA READY pin signals the Command Phase.

### 9.1.7 SPI Command Phase:

The Command Phase indicates the **eS-WiFi** module is ready to accept an **IWIN AT** Command. The command must include all delimiters and data for the command.

Ex. S3=0010\r0123456789

The command must also be sent as one continuous SPI cycle, that is SSN must stay low for the complete command, delimiters, and data.

The Host will initiate a SPI cycle (lower SSN) and clock out the command, delimiters and associated data and raise the NSS signal to indicated that the all data has be sent. As result of the NSS raising the **eS-WiFi** module will lower the CMD/DATA READY pin to signal the end Command Phase.

The data that will be clocked back to the Host will be 0x15 (NAK).

### 9.1.8 SPI Endian Example:

The data is in little endian (0x15 0x15 0x0A 0x0D 0x20 0x3E) and needs to be converted back to big endian with the leading 0x15's removed. Please remember that this is a 16-bit interface so the endian conversion is done one 16-bit at a time.

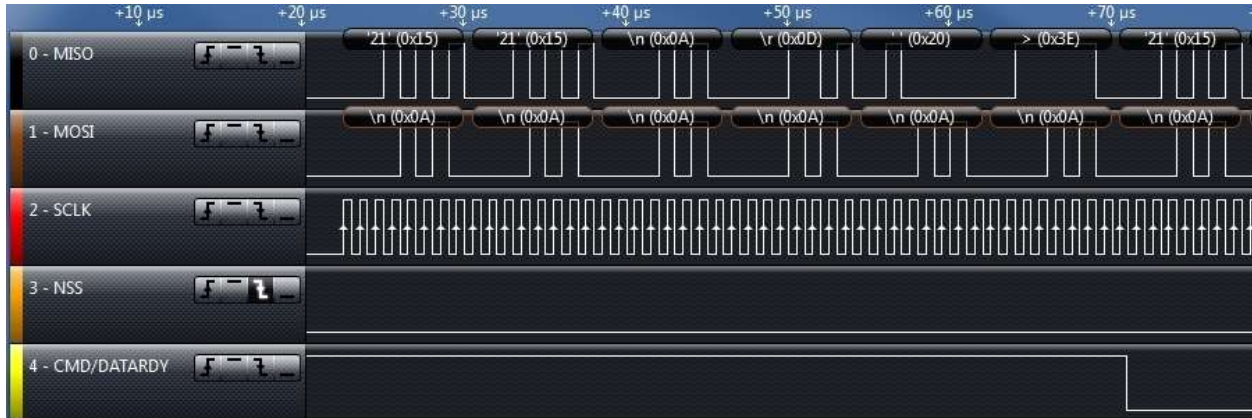

The endian requirement extends to the command being sent to the **eS-WiFi** module. So a “I?r\0A” command would be sent as 0x3F 0x49 0x0A 0x0D.

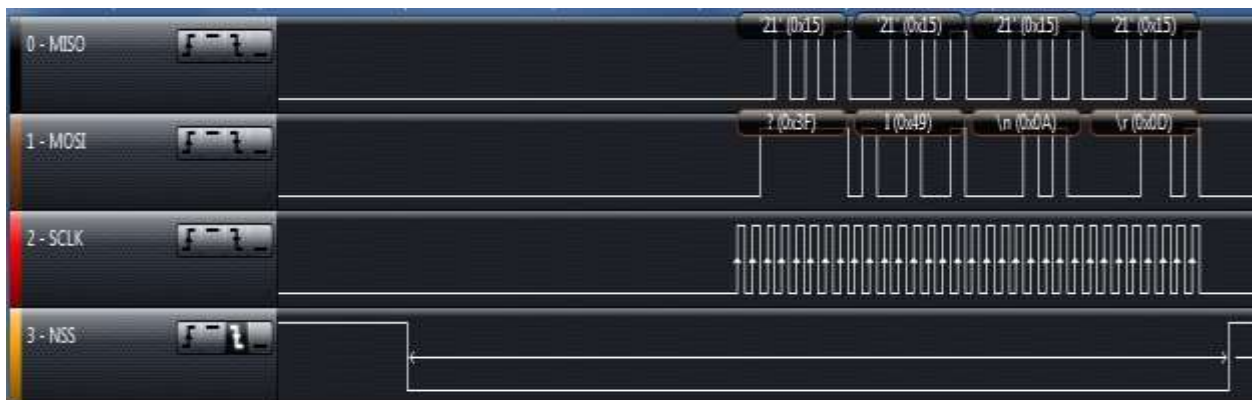

### 9.1.9 SPI Data Phase:

The Data Phase indicates the **eS-WiFi** module has data ready for the Host to read. The **eS-WiFi** module will raise CMD/DATA READY and the Host will initiate a SPI cycle (lower SSN) and clock out 0x0A (Line Feed) until the CMD/DATA READY pin lowers signaling the end of the Data Phase.

### 9.1.10 SPI Asynchronous Messages:

There are certain situations in which the eS-WiFi will issue asynchronous messages:

- Soft AP (AO/AD Commands), when a device connects to the Soft AP a DHCP assigned message will issued.  
Ex. [DHCP ] Assigned 00:00:00:00:00:00 has 192.168.10.100
- TCP/UDP Communication Servers (P5=1), when a client connects to the server a connected message will be issued.  
Ex. [TCP SVR] Waiting on connection...  
[TCP SVR] Accepted 192.168.10.100:2000  
[UDP SVR] Accepted 192.168.10.100:2000

With the SPI host interface being synchronous the Host must poll for these messages. This can be done by using the MR (Message Read) command or when a Communication connection the issuing of a R0 command will read all asynchronous message and the result of the R0 command.

The asynchronous messages are delineated by the Start Of Message Asynchronous ([SOMA]) and End Of Message Asynchronous ([EOMA]) markers.

### 9.1.11 SPI AC Characteristics:

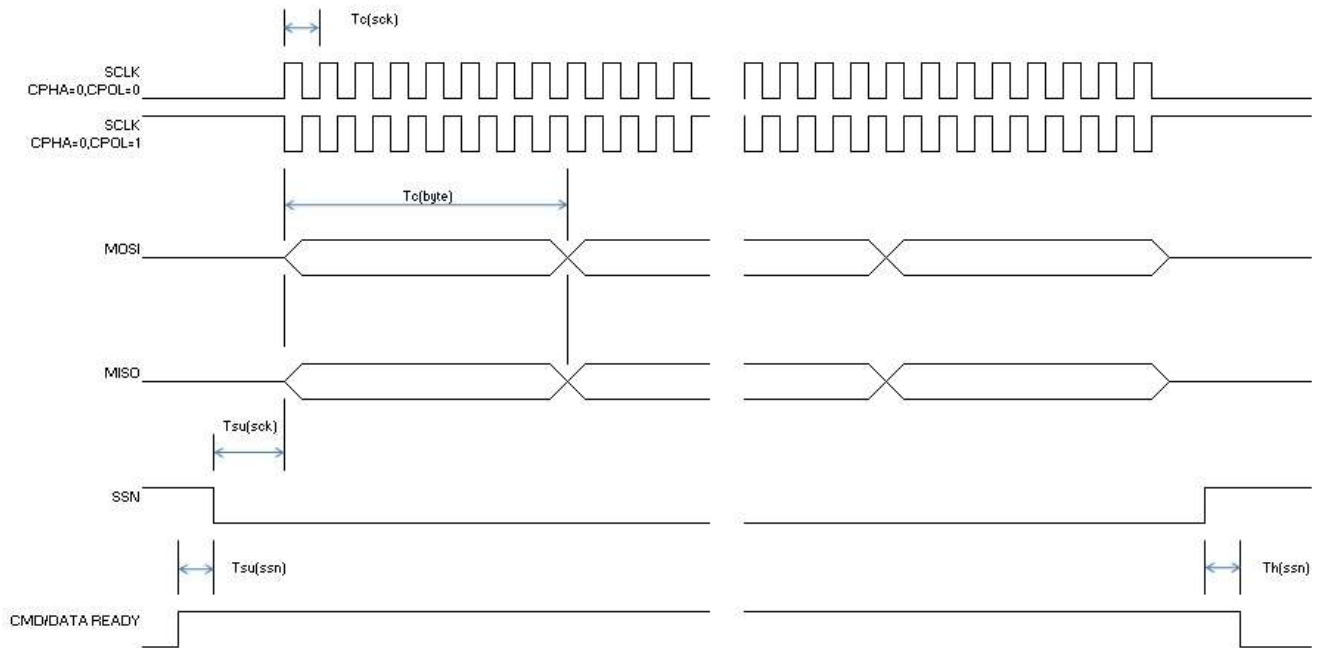

Symbol	Min.	Typ.	Max.
$T_f(\text{sck})$			20 MHz
$T_c(\text{sck})$	50 ns		
$T_{su}(\text{sck})$		15 us	
$T_c(\text{byte})$		$8 * T_c(\text{sck})$	
$T_{su}(\text{ssn})$		4 us	
$T_h(\text{ssn})$		3 us	

## 9.2 USB

The **eS-WiFi** module supports a USB-HID interface. (Contact Inventek for specific firmware.)

## 9.3 GPIO

Each of the GPIO pins can be configured by the **IWIN** AT command set as Button, LED, Digital input or Digital output. The outputs are 3.3V CMOS and reference the **IWIN** AT Command Set User manual to configure.

## 9.4 ADC's

One 12-bit analog-to-digital converter is available. Reference the **IWIN** AT Command Set User's manual for configuration.

## 10 RF SPECIFICATION

### 10.1 Wi-Fi Specification

Conditions: VDD=3.3V; VDDIO=3.3V; TEMP: 25°C

#### 10.1.1 2.4 GHz Band

Feature	Description
WLAN Standard	IEEE 802.11b/g/n, Wi-Fi compliant
Frequency Range	2.400 GHz ~ 2.497 GHz (2.4 GHz ISM Band)
Number of Channels	Ch1 ~ Ch14
Modulation	802.11 g/n : OFDM /64-QAM,16-QAM, QPSK, BPSK 802.11b : CCK, DQPSK, DBPSK
*Output Power	802.11b /11Mbps : 17* dBm ± 1.5 dB
	802.11g /54Mbps: 17* dBm ± 1.5 dB
	802.11n /72Mbps: 16* dBm ± 1.5 dB
Receive Sensitivity (11n,20MHz) @10% PER	- MCS=0 PER @ -86 dBm, typical
	- MCS=1 PER @ -85 dBm, typical
	- MCS=2 PER @ -85 dBm, typical
	- MCS=3 PER @ -84 dBm, typical
	- MCS=4 PER @ -80 dBm, typical
	- MCS=5 PER @ -78 dBm, typical
	- MCS=6 PER @ -72 dBm, typical
Receive Sensitivity (11g) @10% PER	- 6Mbps PER @ -89 dBm, typical
	- 9Mbps PER @ -88 dBm, typical
	- 12Mbps PER @ -88 dBm, typical
	- 18Mbps PER @ -87 dBm, typical
	- 24Mbps PER @ -83 dBm, typical
	- 36Mbps PER @ -80 dBm, typical
	- 48Mbps PER @ -75 dBm, typical
- 54Mbps PER @ -72 dBm, typical	
Receive Sensitivity (11b) @10% PER	- 1Mbps PER @ -93 dBm, typical
	- 2Mbps PER @ -91 dBm, typical
	- 5.5Mbps PER @ -89 dBm, typical
	- 11Mbps PER @ -87 dBm, typical
Data Rates	802.11b : 1, 2, 5.5, 11Mbps
	802.11g : 6, 9, 12, 18, 24, 36, 48, 54Mbps

Data Rate (20MHz ,Long GI,800ns)	802.11n: 6.5, 13, 19.5, 26, 39, 52, 58.5, 65Mbps
Data Rate (20MHz ,short GI,400ns)	802.11n : 7.2, 14.4, 21.7, 28.9, 43.3, 57.8, 65,72.2Mbps
Maximum Input Level	802.11b : -10 dBm
	802.11g : -10 dBm

### 10.1.2 5 GHz Band

Feature	Description
WLAN Standard	802.11a/n, WIFI Compliant
Frequency Range	4.900 GHz ~ 5.845 GHz (5 GHz Band)
Channels	36~48, 52~64, 100~144, 149 ~165
Modulation	802.11a/n OFDM
Output Power	802.11a 19 dBm $\pm$ 1.5 dB
	802.11n 19 dBm $\pm$ 1.5 dB
Receive Sensitivity (11a, 20 Mhz channel spacing for all rates) @10% PER	6 Mbps OFDM PER @ -90.5 dBm, typical
	9 Mbps OFDM PER @ -90.5 dBm, typical
	12 Mbps OFDM PER @ -87.5 dBm, typical
	18 Mbps OFDM PER @ -85.5 dBm, typical
	24 Mbps OFDM PER @ -82.5 dBm, typical
	36 Mbps OFDM PER @ -80.5 dBm, typical
	48 Mbps OFDM PER @ -76.5 dBm, typical
Receive Sensitivity (11n, 20 Mhz channel spacing for all rates) @10% PER	MCS 0 PER @ -90.5 dBm, typical
	MCS 1 PER @ -86.5 dBm, typical
	MCS 2 PER @ -84.5 dBm, typical
	MCS 3 PER @ -82.5 dBm, typical
	MCS 4 PER @ -78.5 dBm, typical
	MCS 5 PER @ -73.5 dBm, typical
	MCS 6 PER @ -71.5 dBm, typical
MCS 7 PER @ -70.5 dBm, typical	
Data Rate 20MHz, 800ns GI	802.11a/n: 6.5, 13, 19.5, 26, 39, 52, 58.5, 65Mbps
Data Rate 20MHz, 400ns GI	802.11a/n : 7.2, 14.4, 21.7, 28.9, 43.3, 57.8, 65,72.2Mbps
Maximum Receive Level @5.24 GHz	@ 6, 9, 12 Mbps -29.5 dBm
	@ 18, 24,36,48,54 Mbps -29.5 dBm

## 10.2 BT/BLE Specification

### 10.2.1 FEATURES:

- Supports a single 2.4 GHz antenna shared between WLAN and Bluetooth
- Bluetooth v4.0 with integrated Class 1 PA, plus 8dBm max TX Pwr.
- Concurrent Bluetooth and WLAN operation
- \*Bluetooth SmartAudio® technology improves voice and music quality to headsets
- \*Bluetooth low power inquiry and page scan
- Bluetooth Low Energy (BLE) support
- \*Bluetooth Packet Loss Concealment (PLC)
- \*Bluetooth Wide Band Speech (WBS)
- The BBC supports all Bluetooth 4.0 features, with the following benefits:
  - Dual-mode classic Bluetooth and classic Low Energy (BT and BLE) operation.
  - Low Energy Physical Layer
  - Low Energy Link Layer
  - Enhancements to HCI for Low Energy
  - Low Energy Direct Test mode
  - AES encryption

**\*NOTE: Support is dependent upon WICED support**

The ISM4340 **eS-WiFi** Module shares a single UART for Bluetooth. Please reference Section 9 for details.

### 10.2.2 PARAMETERS:

**Note:** Values in this datasheet are design goals and are subject to change based on the result of device characterization.

Unless otherwise stated, limit values apply for the conditions specified in Section 5.4, the “Environmental Specification”. Typical values apply for the following conditions:

- VBAT = 3.6V



- Ambient temperature +25°C

<b>Parameter</b>	<b>Conditions</b>	<b>Min</b>	<b>Typical</b>	<b>Max</b>	<b>Unit</b>
Note: The specifications in this table are measured at the Chip port output unless otherwise specified:					
<b>General</b>					
Frequency Range	-	2402	-	2480	MHz
RX sensitivity	GFSK, 0.1% BER, 1 Mbps	-	-93.5	-	dBm
	$\pi/4$ -DQPSK, 0.01% BER, 2 Mbps	-	-95.5	-	dBm
	8-DPSK, 0.01% BER, 3 Mbps	-	-89.5	-	dBm
Input IP3	-	-16	-	-	dBm
Maximum input at antenna	-	-	-	-20	dBm

## 11 ANTENNA

### 11.1 External Antenna

The Inventek U.FL PCB antenna is certified for FCC, IC and CE. The part number is W2.4-5P-U. It is a dual band 2.4/5 GHz PCB antenna with a U.FL connector.

The Inventek W2.4-5P-U PCB antenna datasheet can be found on the Inventek Website.



## 11.2 Mechanical Specifications

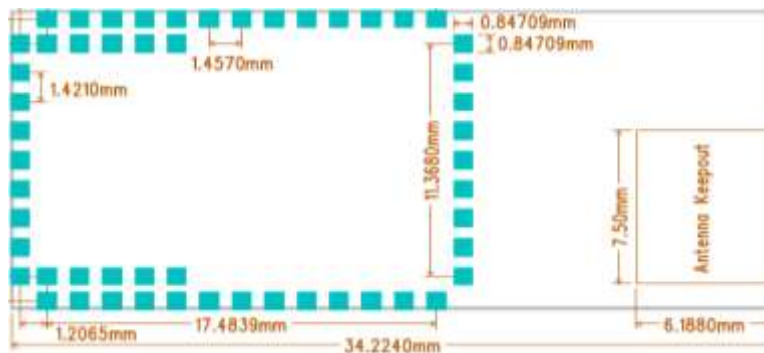

Chip Antenna Keep out Area

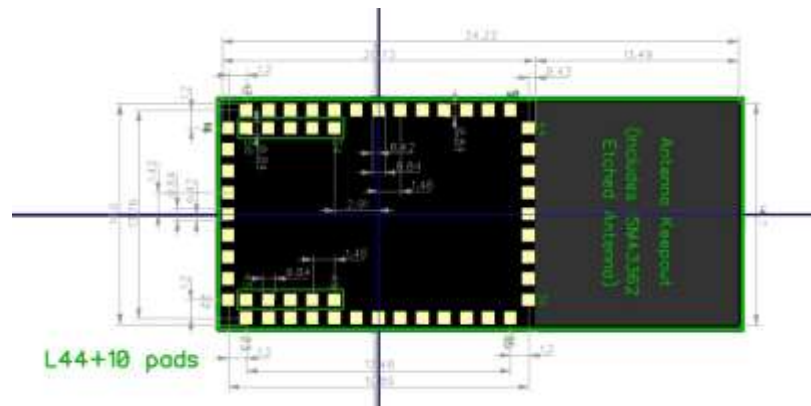

”Keep out” area should ideally have the antenna hanging off the side of the PCB for best performance. If you do not hang the antenna off the side of the PCB, ensure no FR4 or ground planes or traces are placed under the antenna (keep out area). Surrounding metal will affect the antenna performance. Inventek recommends a 9mm clearance on all three sides. The external antenna does not require “keep out” area.

## 12 ON BOARD PROCESSOR

The eS-WiFi includes an ST Microelectronic's, STM32F405 MCU.

ISM43340-M4G-L44	STM32F405 (1 MB), Flash Microcontroller)
------------------	---

Please refer to the STM32F405 specification from ST Microelectronics for further information about the UART and SPI (Slave Mode) interfaces.

<http://www.st.com/web/en/resource/technical/document/datasheet/DM00037051.pdf>

## 13 ISM43340-M4G-L44 FOOTPRINT

### 13.1 ISM43340-M4G-L44-10xx eS-WiFi Module's Dimensions top view (mm)

The ISM43340-M4G-L44-10xx offers 10 extra GPIO pins (pins 45-54), see Figure 3. The module is footprint compatible with our standard 44 pin LGA footprint, see Figure 4

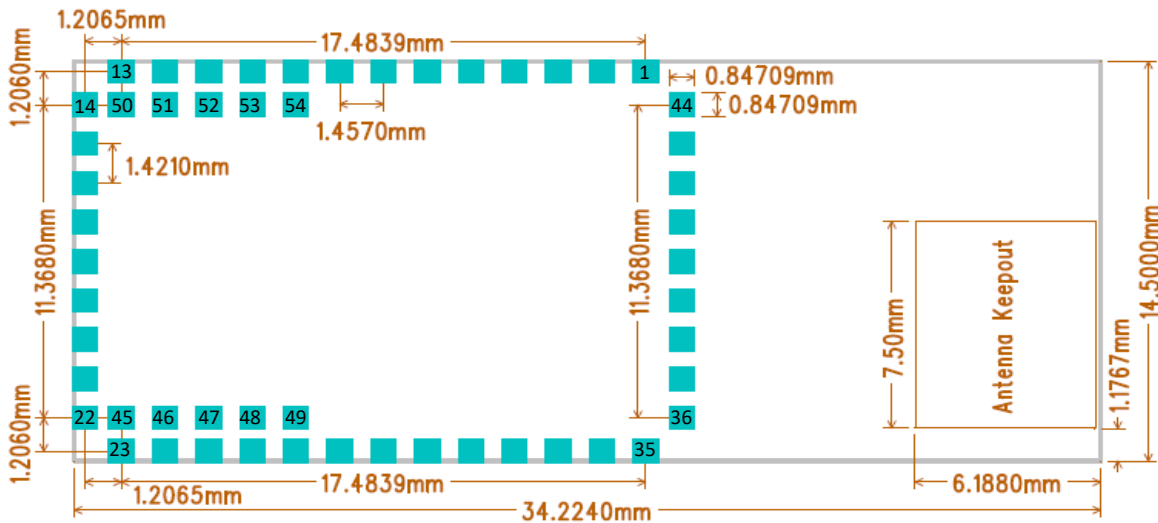

Figure 1 eS-WiFi Module Dimensions- Top View

### 13.2 ISM43340-M4G-L44-xxx Module's Dimensions top view (mm)

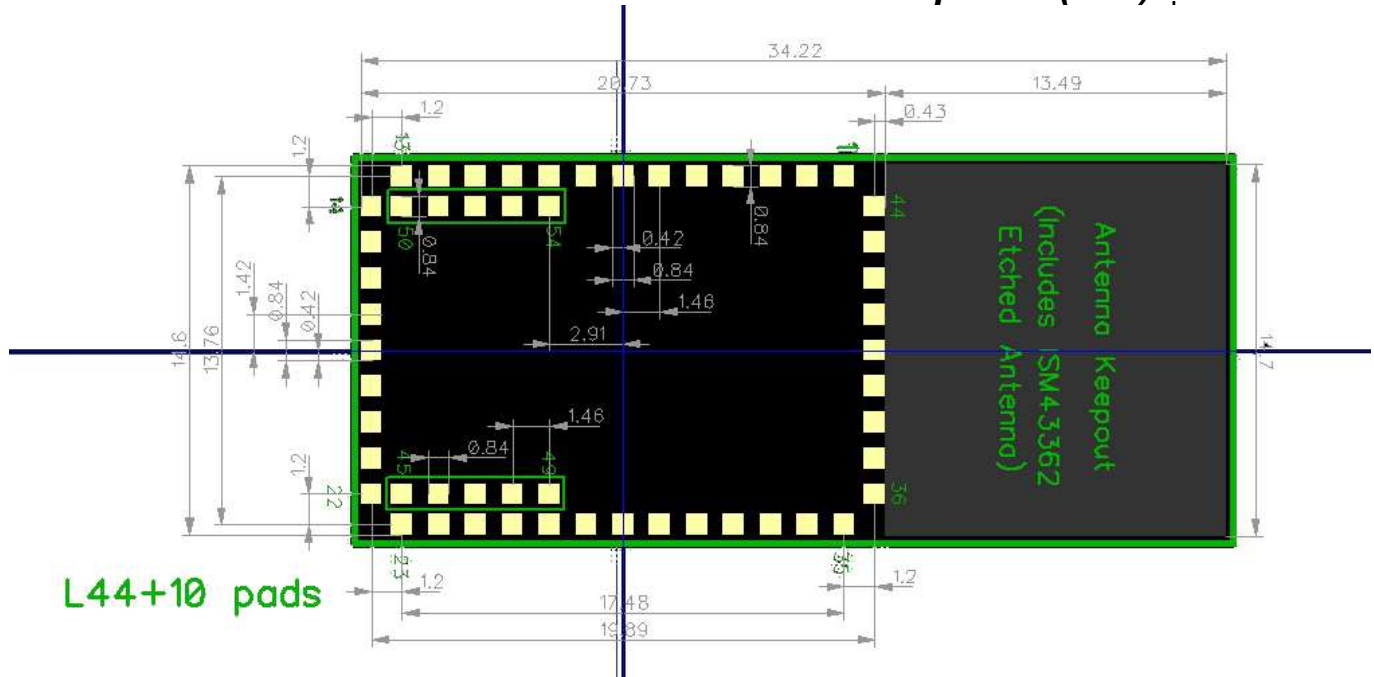

Figure 2 Module Dimensions - Top View

## 14 PRODUCT COMPLIANCE CONSIDERATIONS

**RoHS:** Restriction of Hazardous Substances (RoHS) directive has come into force since 1st July 2006 all electronic products sold in the EU must be free of hazardous materials, such as lead. Inventek is fully committed to being one of the first to introduce lead-free products while maintaining backwards compatibility and focusing on a continuously high level of product and manufacturing quality.

**EMI/EMC:** The Inventek **eS-WiFi** module design embeds EMI/EMC suppression features and accommodations to allow for higher operational reliability in noisier (RF) environments and easier integration compliance in host (OEM) applications.

**FCC/IC/CE:** The **eS-WiFi** module has passed FCC/IC/CE compliance.

## 15 REFLOW PROFILE

- Reference the IPC/JEDEC standard.
- Peak Temperature: <math><250^{\circ}\text{C}</math>
- Number of Times:  $\leq 2$  times

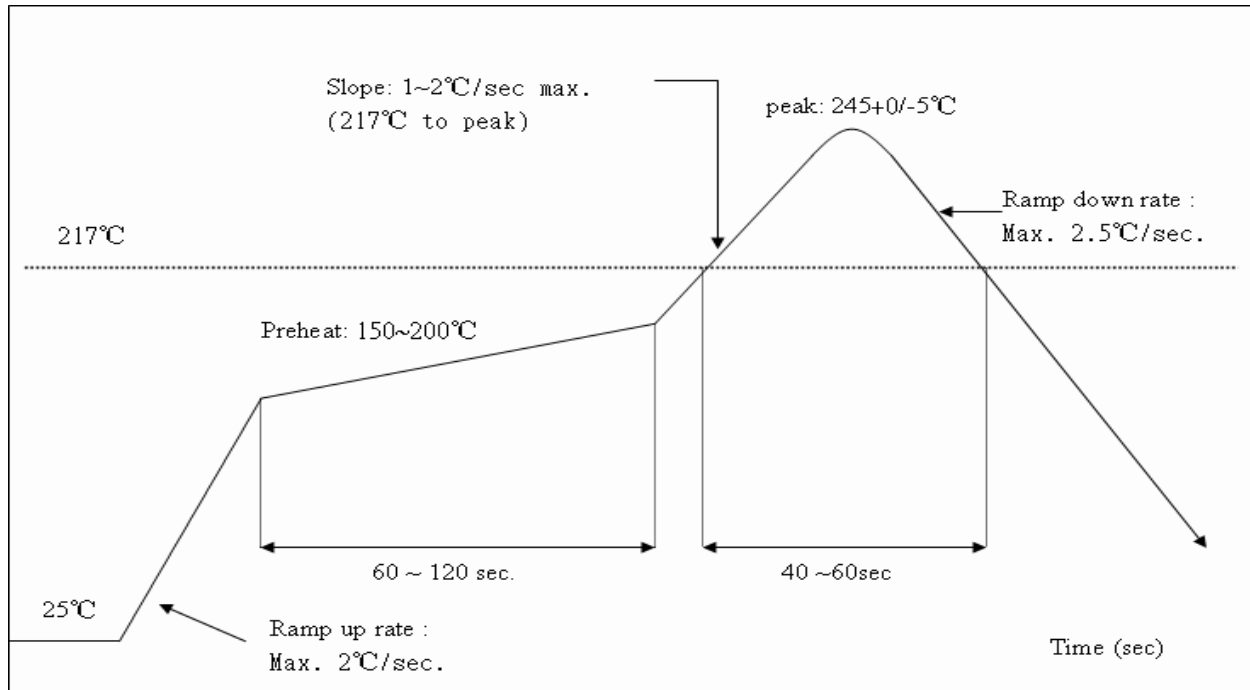

## 16 PACKING INFORMATION

### 16.1 MSL Level / Storage Condition

	<p><b>Caution</b> This bag contains <b>MOISTURE-SENSITIVE DEVICES</b></p>	<p>LEVEL <b>4</b></p>
<p>Do not open except under controlled conditions</p>		
<p>1. Calculated shelf life in sealed bag: 12 months at &lt;math&gt;&lt; 40^{\circ}\text{C}&lt;/math&gt; and &lt;math&gt;&lt; 90\%&lt;/math&gt; relative humidity (RH)</p>		
<p>225<math>^{\circ}\text{C}</math>   240<math>^{\circ}\text{C}</math>   250<math>^{\circ}\text{C}</math>   260<math>^{\circ}\text{C}</math></p>		
<p>2. Peak package body temperature:   <input type="checkbox"/>   <input type="checkbox"/>   <input checked="" type="checkbox"/>   <input type="checkbox"/></p>		
<p>3. After bag is opened, devices that will be subjected to reflow solder or other high temperature process must</p> <p>a) Mounted within: 48 hours of factory conditions &lt;math&gt;&lt; 30^{\circ}\text{C}&lt;/math&gt; / 60% RH, OR</p> <p>b) Stored at &lt;math&gt;&lt; 10\%&lt;/math&gt; RH</p>		
<p>4. Devices require bake, before mounting, if:</p> <p>a) Humidity Indicator Card is &gt;10% when read at &lt;math&gt;23 \pm 5^{\circ}\text{C}&lt;/math&gt;</p> <p>b) 3a or 3b not met</p>		
<p>5. If baking is required, devices may be baked for 24 hours at &lt;math&gt;125 \pm 5^{\circ}\text{C}&lt;/math&gt;</p>		
<p>Note : If device containers cannot be subjected to high temperature or shorter bake times are desired, reference IPC/JEDEC J-STD-033 for bake procedure</p>		
<p>Bag Seal Date:      <b>See-SEAL DATE LABEL</b></p>		
<p>Note: Level and body temperature defined by IPC/JEDEC J-STD-020</p>		

## 16.2 Device baking requirements prior to assembly

*Boards must be baked prior to rework or assembly to avoid damaging moisture sensitive components during localized reflow. The default bake cycles is 24 hours at 125C.*

Maintaining proper control of moisture uptake in components is critical.

Before opening the shipping-bag and attempting solder reflow, you should maintain a minimal out-of-bag time and ensure the highest possible package reliability for the final product.

## 17 REVISION CONTROL

Document: ISM43340-M4G-L44	eS-WiFi module
External Release	DOC-DS-20088

Date	Author	Revision	Comment
9/29/2014	KMT	1.0	Draft
10/10/2014	RLB	1.1	Preliminary Release
4/27/2015	KMT	2.0	Preliminary
12/4/2015	KMT	2.1	Updated P/N, Pin Descriptions, and +10 Footprint
1/12/2016	KMT	2.2	Updated Power Measurements, and Mechanicals
2/2/2016	KMT	2.3	Updated features and host interface options
4/20/2016	KMT	2.4	Updated Mechanicals and Pin descriptions
1/23/2017	SEP	2.4.2	Corrected +10 Pin descriptions
4/10/17	AS	2.4.3	Added I/F & SW to Ordering P/N. Removed NFC. Revised Block Diagram. Added BT/BLE
<b>5/30/17</b>	AS	2.4.4	10-15uF Bulk Cap to VDD_3V3

## 18 CONTACT INFORMATION

Inventek Systems  
2 Republic Road  
Billerica MA, 01862  
Tel: 978-667-1962  
[Sales@inventeksys.com](mailto:Sales@inventeksys.com)

[www.inventeksys.com](http://www.inventeksys.com)

Copyright 2017, Inventek Systems. All Rights Reserved. This software, associated documentation and materials ("Software"), referenced and provided with this documentation is owned by Inventek Systems and is protected by and subject to worldwide patent protection (United States and foreign), United States copyright laws and international treaty provisions. Therefore, you may use this Software only as provided in the license agreement accompanying the software package from which you obtained this Software

("EULA"). If no EULA applies, Inventek Systems hereby grants you a personal, non-exclusive, non-transferable license to copy, modify, and compile the Software source code solely for use in connection with Inventek's integrated circuit products.

Any reproduction, modification, translation, compilation, or representation of this Software except as specified above is prohibited without the express written permission of Inventek. Disclaimer: THIS SOFTWARE IS PROVIDED AS-IS, WITH NO WARRANTY OF ANY KIND, EXPRESS OR IMPLIED, INCLUDING, BUT NOT LIMITED TO, NONINFRINGEMENT, IMPLIED WARRANTIES OF MERCHANTABILITY AND FITNESS FOR A PARTICULAR PURPOSE.

Inventek reserves the right to make changes to the Software without notice. Inventek does not assume any liability arising out of the application or use of the Software or any product or circuit described in the Software. Inventek does not authorize its products for use in any products where a malfunction or failure of the Inventek product may reasonably be expected to result in significant property damage, injury, or death ("High Risk Product"). By including Inventek's product in a High Risk product, the manufacturer of such system or application assumes all risk of such use and in doing so agrees to indemnify Inventek against all liability. Inventek Systems reserves the right to make changes without further notice to any products or data herein to improve reliability, function, or design. The information contained within is believed to be accurate and reliable. However, Inventek does not assume any liability arising out of the application or use of this information, nor the application or use of any product or circuit described herein, neither does it convey any license under its patent rights nor the rights of others.