

L0805C1R5KSMST

Aliases (L0805C1R5KSMST)

Obsolete

KEMET, L-SMS, Commercial Grade, 1.5 uH, 10%

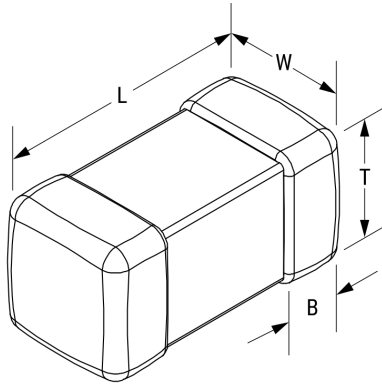

Click [here](#) for the 3D model.

Dimensions

Chip Size	0805
L	2mm +0.3/-0.1mm
W	1.25mm +/-0.2mm
T	0.85mm +/-0.2mm
LL	0.5mm +/-0.2mm
B	0.5mm +/-0.2mm

Packaging Specifications

Packaging	T&R
Packaging Quantity	4000

General Information

Series	L-SMS
Style	SMD Chip
Description	Shielded, Surface Mount Inductor
Features	Standard Type
RoHS	Yes
Core	Ceramic
Winding Type	Multilayer
Notes	Suggested Replacement - https://www.chilisin.com/en-global/Inductor/Product/BSCL_201209/BSCL002012091R5K00 .

Specifications

Inductance	1.5 uH
Inductance Tolerance	10%
Temperature Range	-40/+85°C
Current	50 mAmps (MAX)
DC Resistance	0.5 Ohms
Quality Factor	45 at 10 MHz
Self-Resonant Frequency	60 MHz