



MicroWave Technology

2020-2021

Product Selection Guide



Wideband 2-20 GHz

MMICs

Standard & Custom

Low Noise 1-12 GHz

Avionics

GaN High Power Amplifiers

WiMax 802.16

Broadband 6-18 GHz

Industrial

Low Phase Noise

Space

Low Noise

Gunn Diodes

0.5dB NF FET Chips

Ultra High Linearity

CATV

Military

HBT

Amplifiers and Modules

PHEMT

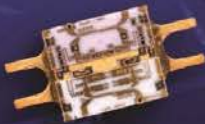

Linear FET



37 Years of Technical Expertise and Innovation

New Products In 2020



NEW PRODUCTS IN 2020

10 - 25W GaN Power Amplifiers				
MODEL	FREQ (GHz)	GAIN (dB)	P-3 (dBm)	SMT Pkg.
NEW! MGA-718540-HP3	7.1-8.5	14	40	HP3
NEW! MGA-718544-HP3	7.1-8.5	13	44	HP3
NEW! MGA-515844-99	5.1-5.8	16	44	99
MGA-242740-02	2.4-2.7	15	40	02
MGA-333840-02	3.3-3.8	12	40	02
MGA-444940-02	4.4-4.9	12	40	02
MGA-445343-99	4.4-5.3	14	43	99
MGA-495940-02	4.9-5.9	16	44	02

GaAs Based Drivers and PAs				
MODEL	FREQ (GHz)	GAIN (dB)	P-1 (dBm)	QFN Pkg.
MMA-011015-C3	1.0-10	15	16	C3
MMA-053223-M4	0.5-3.2	12	24	M4
MMA-020624-M4	2.0-6.0	17	25	M4
MMA-054025-M4	0.5-4.0	11	25	M4
NEW! MMA-445933H-M5	4.4-5.9	31	33	M5
MMA-495933-M5	4.9-5.9	10	33	M5
NEW! MMA-062020-C3	6.0-20	14	18	C3
NEW! MMA-012727-M4	0.1-26.5	12	26	M4
NEW! MMA-012030-M4	0.1-20	12	27	M4
NEW! MMA-174321-M4	17-43	21	18	M4
NEW! MMA-243034D-M5	24-30	25	33	M5
NEW! MMA-212734D-M5	21-27	25	34	M5
NEW! MMA-273334D-M5	27-33	25	33	M5
NEW! MMA-004023D-M4	0.03-40	16	23	M4

Note: All MMICs parts are also available in chip form.

PN	RF Power @12GHz (dBm)	Gain @12GHz (dB)	NF @12GHz (dB)	PAE @12GHz (%)	Chip Size (microns)	Gate Width (microns)	Gate Pads (each)	Drain Pads (each)	Replaces
MwT-1F	24.0	10.0	2.0	--	775 x 241	630	1	1	MwT-1
MwT-3F	22.0	11.0	--	35	406 x 241	300	1	1	MwT-3
MwT-5F	19.0	13.0	3.5	--	406 x 241	300 Dual	1	3	MwT-5
MwT-7F	21.0	11.0	2.0	--	356 x 241	250	2	2	MwT-7, S7, LP7
MwT-9F	26.5	8.5	--	35	419 x 241	750	1	1	MwT-9, A9
MwT-11F	30.0	9.0	--	40	775 x 343	2400	2	2	MwT-11
MwT-PH3F	24.0	16.0	--	60	410 x 340	300	1	1	N/A
MwT-PH4F	22.0	16.0	--	60	365 x 260	180	1	1	MwT-PH4
MwT-PH5F	20.0	20.0	--	45	330 x 400	300 Dual	1	1	MwT-PH5
MwT-PH7F	24.0	16.0	--	60	390 x 260	250	2	2	MwT-PH7
MwT-PH8F	30.0	10.0	--	40	315 x 690	1200	2	2	MwT-PH8
MwT-PH9F	27.0	11.0	--	50	480 x 315	750	1	1	MwT-PH9
MwT-PH11F	32.0	9.0	--	45	775 x 365	2400	2	2	MwT-PH11
MwT-PH15F	28.0	13.0	--	60	850 x 260	630	4	2	MwT-PH15
MwT-PH27F	24.5	16.0	--	40	410 x 340	400	1	1	Qorvo TGF2040
MwT-PH28F	28.0	13.0	--	45	410 x 340	600	1	1	Qorvo TGF2060
MwT-PH29F	29.5	11.0	--	45	410 x 480	800	1	1	RFMD FDP750 BeRex BCP080C
MwT-PH30F	29.5	11.0	--	45	410 x 540	800	2	2	Qorvo TGF2080
MwT-PH31F	31.0	9.0	--	45	540 x 410	1200	2	2	Qorvo TGF2120
MwT-PH32F	32.5	8.0	--	45	540 x 410	1600	2	2	Qorvo TGF2160
MwT-PH33F	24.0	16.0	--	50	315 x 440	300	1	1	N/A

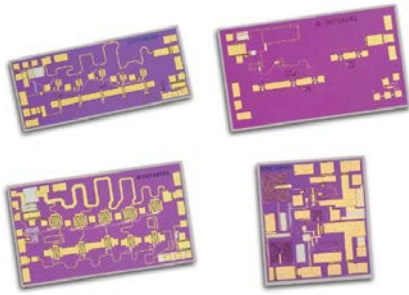

- High Performance/Quality MMIC Based on InGaP HBT, pHEMT, and Linear MESFET Technologies
- High Linearity, Fully Matched WiMax Power Amplifiers
- High Linearity, Broadband Gain Blocks
- Military Screening Available on Hermetically Sealed Package Products
- Low Cost Commercial Products

VSAT and Point-to-Point Radio Applications High Power MMIC Amplifiers

Model	Pkg/ Chip	Freq (GHz)	DC Power To maintain IM3 (W)	Gain (±dB)	P-1 (dBm)	P-3 (dBm)	IM3 @Po=20dBm /tone (dBc)	OIP3 @Po=20dBm /tone (dBm)	Input/Output Return Loss (dB)
MMA-172135-M5**	5X5 QFN	17-21		27	35		!()	(&")	%&
MMA-212734D-M5**	5X5 QFN	21-27		25	34		!(\$		%& #%&
MMA-243034D-M5	5X5 QFN	24-30		23	34	34.5			8/10
MMA-273334D-M5	5X5 QFN	27-33		26	33	34.0			10
MMA-273336	Chip	27-33	13.2W (6V 2.2A)	22	35.5	36.5	' *	' ,	%\$
MMA-273336-M5	5X5 QFN	27-33	13.2W (6V 2.2A)	22	35.5	36.5	' *	' ,	%\$
MMA-273336D-M5	5X5 QFN	27-33	13.2W (6V 2.2A)	22	35.5	36.5	' *	' ,	%\$
MMA-374030-M5**	5X5 QFN	37-40	10.8W (6V 1.8A)	24	31	32.0	' - †	' , †	%\$

* AT +18dBm per tone, ** Chip version of this model is available. Please contact our sales team for special order.

VSAT and Point-to-Point Radio Applications High Linearity MMIC Amplifiers

Model	Pkg/ Chip	Freq (GHz)	DC Power To maintain IM3 (W)	Gain Typ/Min (dB)	P-1 (dBm)	P-3 (dBm)	IM3 @Po=20dBm /tone (dBc)	OIP3 @Po=20dBm /tone (dBm)	Input/Output Return Loss (dB)
MMA-070936-M5	5X5 QFN	7-8.5	18W (6V 3A)	28.5 / 28.0	34	36	50	45	15
MMA-121633-M5	5X5 QFN	12.5-15.5	8.4W (6V 1.4A)	23.5 / ---	32	34	44	42	10
MMA-374030-M5**	5X5 QFN	37-40	10.8W (6V 1.8A)	24.0	31	32	39*	38*	10
MMA-445933H-02	02	4.4-5.9	---	33.0 / 29.0	33	---	---	45	10 / 7
MMA-445933H-M5	02	4.4-5.9	---	31	33	---	---	45	10 / 7
MMA-495933-M5**	5X5 QFN	4.9-5.9	---	10.5 / 10.0	33	---	---	46	9.6 / 4.8

* AT +18dBm per tone, ** Chip version of this model is available. Please contact our sales team for special order.

Driver Amplifiers

Model	Pkg/ Chip	Freq (GHz)	DC Power To maintain IM3 (W)	Gain (dB)	P-1 (dBm)	P-3 (dBm)	Gain Flatness (dB)	OIP3 @Po=10dBm /tone (dBm)	Input/Output Return Loss (dB)
MMA-062020	Chip	6-20	0.6W (5V 0.12A)	13.5	18.3	19.5	+/- 1.0	28	10
MMA-062020-C3	3X3 QFN	6-20	0.6W (5V 0.12A)	13.5	18.3	19.5	+/- 1.0	28	10
MMA-174321	Chip	17-73	1.125W (4.5V 0.25A)	20.0	21.0	22.0	+/- 2.5	26*	8
MMA-174321-M4	4X4 QFN	17-43	1.125W (4.5V 0.25A)	20.0	21.0	22.0	+/- 2.5	26	8

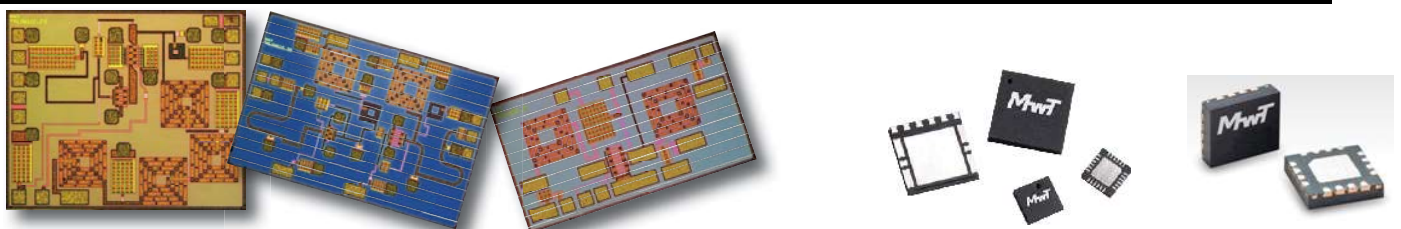

Traveling Wave Amplifiers

Model	Pkg/Chip	Freq (GHz)	DC Power To maintain IM3 (W)	Gain (dB)	P-1 (dBm)	P-3 (dBm)	Gain Flatness (dB)	OIP3 @Po=10dBm /tone (dBm)	Input/Output Return Loss (dB)
MMA-005022B	Chip	30KHz-50	1.4W (7V 0.2A)	15.5	22	25	+/- 1.0	37	10
MMA-005022-M4	4X4 QFN	30KHz-50	1.4W (7V 0.2A)	15.5	22	25	+/- 1.0	37	10
MMA-012030	Chip	0.1-20	6W (12V 0.5A)	12.5	27	29	+/- 0.5	37	10
MMA-012727	Chip	0.1-26.5	3.5W (10V 0.35A)	12.5	26	27	+/- 0.5	35	11
MMA-012727-M4	4X4 QFN	0.1-26.5	3.5W (10V 0.35A)	12.5	26	27	+/- 0.5	35	11

High Linearity Broadband Driver Amplifiers

Model	Pkg/Chip	Freq (GHz)	Linear Gain Typ/Min (dB)	Gain Flatness Typ/Max (±dB)	Input RL Typ (dB)	Output RL Typ (dB)	NF Typ (dB)	Pout @-1dB Typ (dBm)	OIP3 Typ (dBm)	Vdd (V)	DC Current Typ/Max (mA)
MMA-011015	Chip	1-10	15 / ---	2.5 / ---	12	15	4.5	16	---	6.0	75 / ---
MMA-011015-C3	3X3 QFN	1-10	15 / ---	2.5 / ---	10	10	4.5	16	---	6.0	75 / ---
MMA-053223	Chip	.5-3.2	12 / ---	1.5	10	10	3.5	24	42	6.0	120 / 200
MMA-053223-M4	4X4 QFN	.5-3.2	12 / ---	1.5	10	10	3.5	24	42	6.0	120 / 200
MMA-054025	Chip	.5-4	11 / ---	1.0	10	10	3.5	25	44	7.5	--- / 350
MMA-054025-87	87	.5-4	11 / ---	1.0	10	10	3.5	25	44	7.5	--- / 350
MMA-054025-M4	4X4 QFN	.5-4	11 / ---	1.0	10	10	3.5	25	44	7.5	--- / 350
MMA-053026-82	82	.9-2	--- / 11	--- / 2.0	10	8	3.0	25 min	44	8.0	220 / 300

Broadband Low Noise Amplifiers

Model	Pkg/Chip	Freq (GHz)	Linear Gain Typ (dB)	Gain Flatness Typ (±dB)	Input RL Typ (dB)	Output RL Typ (dB)	NF Typ (dB)	Pout @-1dB Typ (dBm)	Vdd (V)	DC Current Typ (mA)
MLA-0122B	Chip	1-10	17.0	1.0	14	11	1.6	16	5.0	55
MLA-0122B-C4	4X4 QFN	1-10	17.0	1.0	14	11	1.6	16	5.0	55
MLA-0122B-H7	H7	1-12	16.0	1.0	10@1-8GHz	13@1-8GHz	1.9@6GHz	16@6GHz	5.0	55
MLA-0522A	Chip	.2-1	17.0	0.5	12	20	1.0	16	3.0	70
	Chip	1-2	16.0	1.3	14	13	1.5	15	3.0	70
MLA-0522A-87	87	.2-1	17.5	1.0	10	11	1.0	15	3.0	65
	87	1-2	15.0	1.3	13	12	1.2	15	3.0	65

High Linearity Driver Amplifiers for WiMax/WLAN

Model	Pkg/Chip	Freq (GHz)	Linear Gain Typ/Min (dB)	Gain Flatness Typ/Max (±dB)	Input RL Typ (dB)	Output RL Typ (dB)	NF Typ (dB)	Pout @-1dB Typ (dBm)	OIP3 Typ (dBm)	Vdd (V)	DC Current Typ/Max (mA)
MMA-020624	Chip	2-4	17 / 15	1 / 1.5	12	12	3.0	25	40	8.0	250 / 300
	Chip	2-6	17 / 15	1 / 1.5	11	10	3.0	25	40	8.0	250 / 300
MMA-020624-M4	4X4 QFN	2-4	17 / 15	1 / 1.5	12	12	3.0	25	40	8.0	250 / 300
	4X4 QFN	2-6	17 / 15	1 / 1.5	11	10	3.0	25	40	8.0	250 / 300
MMA-495930-Q4**	4X4 QFN	4.9-5.9	20 / 18	1 / 1.2	8	8	---	30	45	7.5	450 / 500
MMA-495933-M5**	5X5 QFN	4.9-5.9	10.5 / 10	---	9.6	4.8	---	33	46	7.5	600 / ---

** Chip version of this model is available. Please contact our sales team for special order.

MwT has been providing components and semiconductor devices to the space industry since 1985. MwT performs assembly, testing, screening, and qualifications testing for microwave semiconductor devices, microwave components and subsystems based on MIL-PRF-38534 and according to military and government Hi-Rel standards such as MIL-PRF-38535, MIL-STD-202, MIL-STD-883, MIL-STD-750, MIL-STD-810, MIL-Q-9858, MIL-STD-19500 and MIL-I-45208.

Some of MwT's space qualified products are highlighted in this section.

Equivalent screening to MIL-PRF-38534 class H and K, and NASA programs.

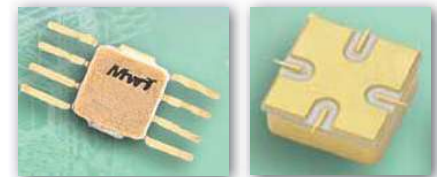

Space Qualified Low Noise Amplifiers

Model	Pkg/ Chip	Freq (GHz)	Linear Gain Typ/Min (dB)	Gain Flatness Typ/MAX (±dB)	Input RL Typ (dB)	Output RL Typ (dB)	NF Typ (dB)	Pout @ -1 dB Typ (dBm)	OIP3 Typ (dBm)	Vdd (V)	DC Current Typ/Max (mA)
LN-162315-H4	H4	1.6-2.3	26	0.3	16	16	1.5	12	-	5	38
LN-141510-H4	H4	0.150	28	1.0	12	10	1.0	16	26	12	30
GM-141526-H4	H4	0.150	20	1.0	14	14	5.0	26	37	12	150
MLA-01122B	C4,H6	1-10	17	1.0	14	11	1.6	16	-	5	55
MLA-0522A	87	.2-1 1-2	17 16	0.5 1.3	12 14	20 13	1.0 1.5	16 15	-	3 3	70 70

Space Qualified and Hi-Rel GaAs FETs

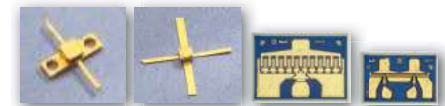

Model	Pkg/ Avail.	Gate Width / Length (um)	Gate Layout Method	Gate Drain Source Bond Qty	Chip Thickness & VIA (mil.)	S.S. Gain @ 12 GHz Typ/Min (dB)	N.F. @ 12 GHz Typ/Min (dB)	Ga @ N.F. @ 12 GHz Typ/Min (dB)	P-1dB @ 12 GHz Typ/Min (dBm)	IP3 @ 12 GHz Typ/Min (dBm)	Chip Size (um - um)	Ideal Circuit
MwT-1	70, 71	630/0.3	single stripe	1, 1, 2	5, no	10.0 / 9.0	2.0 / -	7.0 / -	24.0/23.0	- / -	775 • 241	FB Amp
MwT-2	70, 71	630/0.3	single stripe	2, 2, 3	5, no	8.5 / 8.0	- / -	- / -	24.5/23.0	- / -	775 • 241	BA Amp
MwT-3	70, 71	300/0.3	single stripe	1, 1, 2	5, no	11.0 / 10.0	- / -	- / -	21.0/20.0	- / -	406 • 241	BA Amp
MwT-7	70	250/0.3	single stripe	2, 2, 2	5, no	10.5 / 10.0	2.0 / -	8.0 / -	20.0/18.0	- / -	356 • 241	BA/SE Amp
MwT-LP7	70	250/0.3	single stripe	2, 2, 2	5, no	10.5 / 10.0	2.0 / -	8.0 / -	20.0/18.0	- / -	356 • 241	Oscillator
MwT-PH4	70,73,71	180/0.3	single stripe	1, 1, 2	5, no	13.0 / 12.0	1.2 / -	8.0 / -	20.0/18.0	- / -	356 • 241	Osc & Amp
MwT-PH7	70, 71	250/0.3	single stripe	2, 1, 2	4, no	13.5 / 12.0	- / -	- / -	24.0/22.0	- / -	356 • 241	Medium pow
MwT-PH9	70,73,71	750/0.3	single stripe	1, 1, 2	4, no	10.0 / 9.0	- / -	- / -	27.0/26.0	- / -	419 • 292	Power Amp
MwT-8	71	2400/0.3	Interdigit	2, 2, 3	4, no	7.5 / 7.0	- / -	- / -	28.0/27.0	- / -	673 • 305	Power Amp
MwT-9	70, 71	750/0.3	Interdigit	1, 1, 2	5, no	9.0 / 8.0	2.0 / -	6.5 / 6.0	26.0/-	- / -	419 • 292	FB Amp
MwT-A9	70, 71	750/0.3	Interdigit	1, 1, 2	5, no	9.5 / 8.5	1.8 / -	6.5 / 6.0	25.5/23.0	- / -	419 • 292	FB Amp

Capabilities

Products Available for Space Screening

- GaAs FETs
- Microwave Bipolar Transistors
- Microwave Diodes
- Microwave Components such as hybrid amplifiers
- Microwave Subsystems
- Microwave Amplifiers

Screening

- Element Evaluation, Group A, B, C, and D
- Assembly and 100% Screening
- Qualification Testing

Testing

- DC and RF Parameters

Program Management

- ISO Qualified Quality System

Standard GaAs FETs/PHEMTs/HFETs



MwT Standard GaAs FETs / PHEMTs RF Properties (DC Properties Listed on the next page)

Standard GaAs

FETs*

Model	Package Available Sealed/ Hermetic	Gate Width/ Length (um)	Gate Layout Method	Gate Drain Source Bond Pads	Chip Thickness, VIA (mil)	S.S. Gain @ 12 GHz Typ/Min (dB)	N.F. @ 12 GHz Typ/Min (dB)	Ga @ N.F. 12 GHz Typ/Min (dB)	P-1dB @ 12 GHz Typ/Min (dBm)	IP3 @ 12 GHz Typ (dBm)	Chip Size (um - um)
MwT-1	70, 73 / 71	630 / 0.3	single stripe	1, 1, 2	5, no	10.0 / 9.0	2.0 / -	7.0 / -	24.0/23.0	-	775 • 241
MwT-2	70, 73 / 71	630 / 0.3	single stripe	2, 2, 3	5, no	8.5 / 8.0	- / -	- / -	24.5/23.0	-	775 • 241
MwT-3	70, 73 / 71	300 / 0.3	single stripe	1, 1, 2	5, no	11.0 / 10.0	- / -	- / -	21.0/20.0	-	406 • 241
MwT-4	70, 73 / N/A	180 / 0.3	single stripe	1, 1, 2	5, no	9.0 / 8.0	1.5 / 1.8	9.0 / 8.0	14.0/13.0	-	356 • 241
MwT-5	N/A / N/A	2 • 300 / 0.3	dual gate	3, 1, 2	5, no	13.0 / 12.0	3.5 / -	11.0 / -	19.0/15.0	-	406 • 241
MwT-7	70, 73 / N/A	250 / 0.3	single stripe	2, 2, 2	5, no	10.5 / 10.0	2.0 / -	8.0 / -	20.0/18.0	-	356 • 241
MwT-LP7 **	70, 73 / N/A	250 / 0.3	single stripe	2, 2, 2	5, no	10.5 / 10.0	2.0 / -	8.0 / -	20.0/18.0	-	356 • 241
MwT-8	71	2400 / 0.3	Interdigit	2, 2, 3	4, no	7.5 / 7.0	-	-	28.0/27.0	-	673 • 305
MwT-A9	70, 73 / 71	750 / 0.3	Interdigit	1, 1, 2	5, no	9.5 / 8.5	1.8 / -	6.5 / 6.0	25.5/23.0	-	419 • 292
MwT-A989	SOT-89	750 / 0.5	Interdigit	1, 1, 2	4, no	17.0/15.0 (1)	0.9 (1)	-	25.0/23.0	40	419 • 292
MwT-A989SB	SOT-89	750 / 0.5	Interdigit	1, 1, 2	4, no	17.0/15.0 (1)	0.9 (1)	-	25.0/23.0	40	419 • 292
MwT-11	71	2400 / 0.3	Interdigit	2, 2, 3	4, no	9.0 / 7.0	-	-	30.0/28.0	-	775 • 343
MwT-17	89 / 71	2400 / 0.8	Interdigit	4, 4, 5	5, no	7.0 / 6.0	-	-	29.5/28.5	45/-	1130 • 279
MwT-1789	SOT-89	2400 / 0.8	Interdigit	4, 4, 5	4, no	--	(3)	14.0 (1)	28.0	46	1130 • 279
MwT-1789SB	SOT-89	2400 / 0.8	Interdigit	4, 4, 5	4, no	--	(3)	18.0 (1)	28.0	44	1130 • 279
MwT-17Q3	QFN	2400 / 0.8	Interdigit	4, 4, 5	4, no	18.0/16.0 (1)	1.5 (1)	-	28.0/27.0	46	1130 • 279
MwT-PH4	70, 73 / 71	180 / 0.3	single stripe	1, 1, 2	5, no	11.0 / 10.0	1.2	13 / 12.0	20.0/18.0	-	356 • 241
MwT-PH5	-	300 / 0.3	single stripe	1, 1, 2	4, no	18.0 / 15.0	2.0 / -	12.0 / -	20.0/18.0	-	406 • 241
MwT-PH7	70, 73 / 71	250 / 0.3	single stripe	2, 1, 2	4, no	13.5 / 12.0	-	-	24.0/22.0	-	356 • 241
MwT-PH8	71	1200 / 0.3	Interdigit	2, 2, 3	4, no	10.0 / 9.0	-	-	30.0/29.0	-	673 • 305
MwT-PH9	70, 73 / 71	750 / 0.3	Interdigit	1, 1, 2	4, no	10.0 / 9.0	-	-	27.0/26.0	-	419 • 292
MwT-PH11	71	2400 / 0.3	Interdigit	2, 2, 3	4, no	9.0 / 7.0	-	-	32.0/30.0	42	775 • 343
MwT-PH15	70, 73 / 71	630 / 0.3	single stripe	3, 2, 5	4, no	12.0 / 10.0	-	-	28.5/27.0	-	775 • 241
MwT-PH16	71	900 / 0.3	single stripe	6, 2, 7	4, no	11.5 / 10.0	-	-	30.0/28.5	-	1067 • 241
MwT-PH16A	71	1600 / 0.25	Interdigit	4, 4, 5	4, no	11.0 / 9.5	-	-	31.0/29.0	-	1126 • 330

SB = Self-Biased

(1) @ 2.0GHz, (2) noise figure = 0.8dB @ 0.9GHz, (3) noise figure = 3.0dB @ 2.0GHz, (4) noise figure = 1.3dB @ 2.0GHz, (5) @ 4.0GHz

* Consult Factory for Available Packaging: 70 / 73 / 71 / 89 / Q3.

** Low Phase Noise

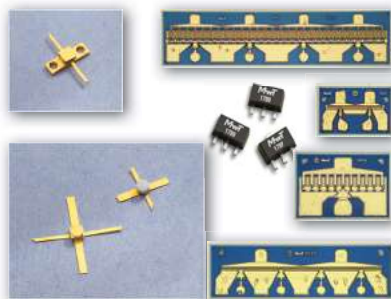

- Ultra Linear, High Dynamic Range, Low Phase Noise
- GaAs Process is Approved for Space Applications with Proven Reliability
- Commercial, Industrial, Military, and Space Grades
- Sample Bond Pull, Die Shear, Wafer DC Burn In, and Bake Tests for wafer evaluation per MILPRF-38534
- 100% Die Probe Test with Data Recorded
- 100% Visual Inspection (to level 1, 3, or 4)
- 100% Idss Match to Provide Performance Consistency
- RF Sample Test Capability Available Upon Request
- Standard and Custom Device Specifications
- Hi-Rel and Space-Rel Screening Options Available
JAN, JANTX, JANTXV, JANS
- RoHS (lead-free) Compliant Product Available
- Available in Chip and Package

MwT Standard GaAs FETs / PHEMTs DC Properties (RF Properties Listed on the previous page)

FETs* (cont.)

Model	Device Type	IDSS Range Min/Max (mA)	Gm Tested Vds/Vgs (V/V)	Gm Typ/Min (mS)	Vp Tested at Vds/Ids (V/mA)	Vp Typ/Max (-V)	Bvgso Tested lgs (-mA)	Bvgso Typ/Min (-V)	Bvgdo Tested lgs (-mA)	Bvgdo Typ/Min (-V)	Vds Absolute Max (V)	Chip Rth Typ (°C/W)	Ideal Circuit
MwT-1	MESFET	60 / 240	4.0 / 0.0	120 / 90	3.0 / 4.0	2.0 / 5.0	1.0	10.0 / 5.0	1.0	10.0 / 6.0	6.0	80	FB Amp
MwT-2	MESFET	60 / 240	4.0 / 0.0	100 / 75	3.0 / 4.0	2.0 / 5.0	0.4	12.0 / 6.0	0.4	12.0 / 8.0	7.0	80	BA Amp
MwT-3	MESFET	30 / 120	4.0 / 0.0	55 / 35	3.0 / 2.0	2.0 / 5.0	0.2	12.0 / 6.0	0.2	12.0 / 8.0	7.0	150	BA Amp
MwT-4	MESFET	18 / 66	3.0 / 0.0	35 / 27	3.0 / 1.0	1.5 / 4.0	0.2	8.0 / 5.0	0.2	8.0 / 6.0	6.0	250	Osc & Amp
MwT-5	MESFET	30 / 110	2.0 / 0.0	40 / 23	3.0 / 0.0	2.0 / 4.5	0.4	8.0 / 5.0	0.4	10.0 / 7.0	6.5	150	Buffer Amp
MwT-7	MESFET	26 / 98	3.0 / 0.0	45 / 36	3.0 / 1.0	1.5 / 4.5	0.4	8.0 / 5.0	0.4	8.0 / 6.0	6.0	180	BA/SE Amp
MwT-LP7	MESFET	38 / 98	3.0 / 0.0	45 / 36	3.0 / 1.0	1.5 / 4.5	0.4	8.0 / 5.0	0.4	8.0 / 6.0	6.0	180	Oscillator
MwT-8	MESFET	120 / 480	2.5 / 0.0	160 / 144	3.0 / 5.0	2.0 / 5.0	1.2	12.0 / 8.0	1.2	12.0 / 8.0	7.5	45	Power Amp
MwT-A9	MESFET	78 / 282	2.0 / 0.0	120 / 95	3.0 / 5.0	2.0 / 5.0	1.0	10.0 / 5.0	1.0	10.0 / 6.0	6.0	70	FB Amp
MwT-A989	MESFET	100 / 200	2.0 / 0.0	90 / 120	3.0 / 5.0	2.5 / 5.0	1.0	10.0 / 5.0	1.0	10.0 / 6.0	8.0	75	Power Amp
MwT-A989SB	MESFET	100 / 200	2.0 / 0.0	90 / 120	3.0 / 5.0	2.5 / 5.0	1.0	10.0 / 5.0	1.0	10.0 / 6.0	8.0	75	Power Amp
MwT-11	MESFET	240 / 920	2.5 / 0.0	380 / 290	3.0 / 16.0	2.0 / 5.0	2.4	12.0 / 8.0	2.4	12.0 / 8.0	8.0	28	Power Amp
MwT-17	MESFET	240 / 920	2.0 / 0.0	380 / 290	3.0 / 6.0	2.5 / 5.0	1.6	12.0 / 6.0	1.6	12.0 / 8.0	7.0	33	High Linearity
MwT-1789	MESFET	440 / 680	2.5 / 0.0	380 / 290	3.0 / 16.0	2.0 / 5.0	2.4	12.0 / 6.0	2.4	12.0 / 9.0	8.0	35	High Linearity
MwT-1789SB	MESFET	440 / 680	2.0 / 0.0	380 / 290	3.0 / 16.0	2.5 / 5.0	2.4	12.0 / 6.0	2.4	12.0 / 9.0	8.0	30	Power Amp
MwT-17Q3	MESFET	440 / 680	2.5 / 0.0	380 / 290	3.0 / 16.0	2.0 / 5.0	2.4	12.0 / 6.0	2.4	12.0 / 9.0	8.0	35	Power Amp
MwT-PH4	PHEMT	18 / 66	2.5 / 0.0	58 / 36	3.0 / 1.0	1.2 / 2.5	0.4	12.0 / 6.0	0.4	12.0 / 8.0	7.0	210	Osc & Amp
MwT-PH5	PHEMT	40 / 120	2.5 / 0.0	60 / 40	3.0 / 2.0	1.2 / 2.5	0.4	12.0 / 6.0	0.4	13.0 / 10.0	7.0	150	Power Amp
MwT-PH7	PHEMT	50 / 122	2.5 / 0.0	80 / 50	3.0 / 1.0	1.2 / 2.5	0.4	12.0 / 6.0	0.4	12.0 / 8.0	7.0	150	Medium pow
MwT-PH8	PHEMT	240 / 600	2.5 / 0.0	320 / 240	3.0 / 8.0	1.2 / 2.5	1.2	12.0 / 6.0	1.2	13.0 / 10.0	8.0	40	Medium pow
MwT-PH9	PHEMT	120 / 292	2.5 / 0.0	200 / 150	3.0 / 5.0	1.2 / 2.5	1.0	12.0 / 6.0	1.0	13.0 / 10.0	8.0	56	Power Amp
MwT-PH11	PHEMT	440 / 800	2.0 / 0.0	800 / 450	3.0 / 16.0	1.2 / 2.5	2.4	12.0 / 6.0	2.4	13.0 / 10.0	8.0	24	Power Amp
MwT-PH15	PHEMT	120 / 240	2.5 / 0.0	200 / 130	3.0 / 2.0	1.2 / 2.5	1.0	12.0 / 6.0	1.0	13.0 / 10.0	8.0	65	Medium pow
MwT-PH16	PHEMT	150 / 360	2.5 / 0.0	280 / 180	3.0 / 3.0	1.2 / 2.5	1.0	12.0 / 6.0	1.0	13.0 / 10.0	8.0	45	Medium pow
MwT-PH16A	PHEMT	300 / 600	2.0 / 0.0	400 / 300	3.0 / 2.0	1.2 / 2.5	2.0	8.0 / 6.0	2.0	13.0 / 10.0	9.0	30	Medium pow

* Consult Factory for Available Packaging: 70 / 73 / 71 / 89 / Q3

NOTE: Consult Factory For Binning Ranges

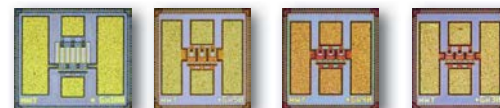

Low Noise GaAs FETs

Model	Gate Width/Length (um)	NF @ 12 GHz Typ (dB)	NF @ 4 GHz Typ (dB)	Ga @ N.F @ 12 GHz Typ/Min (dB)	Ga @ N.F @ 4 GHz Typ (dB)	P-1dB @ 12 GHz Typ (dBm)
MwT-LN180	180 / 0.15	0.50	0.20	10 / --	14.5	16.0
MwT-LN240	240 / 0.15	0.50	0.20	10 / --	13.0	16.0
MwT-LN300	300 / 0.15	0.60	0.20	10 / --	13.0	16.0
MwT-LN600	600 / 0.15	0.50	0.20	9 / 8	12.0	20.0

MPS, ULA, WPS, and MGA

- Miniature, Low Cost, SMT, Flange, & Leadless Package Options
- Miniature, High Reliability, Hermetic SMT Options
- Low Noise, High Linearity, and Broadband Options
- Suitable for High Dynamic Range LNA Applications
- Suitable for High Linear Driver Amp Gain Stages
- Low VSWR for Improved Cascade
- Performance Wireless Amplifiers (MPS, ULA and WPS WiMax)
- Single Voltage Supply and Low Current Operation
- Most Parts are Eutectic Assembly for High Reliability
- Standard and Custom Amplifier Specifications
- Hi-Rel and Space-Rel Screening Available (class H and K)
- GaAs MESFET and GaN PHEMT Devices

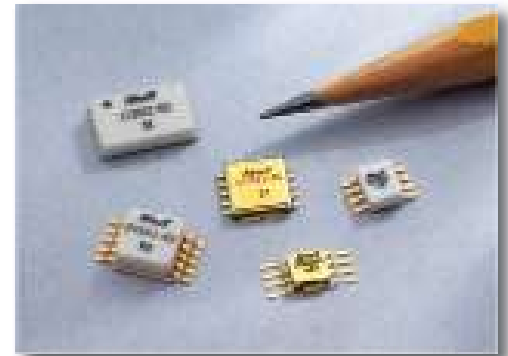

High Linearity MPS

Model	Case Code (-XX) Sealed SMT, Flange	Freq Range (MHz)	Linear Gain Typ/Min (dB)	Gain Flatness Typ/Max (±dB)	VSWR Input Typ/Max (dB)	VSWR Output Typ/Max (dB)	Noise Figure Typ/Max (dB)	Pout @ -1 dB Typ/Min (dBm)	IP3 Typ/Min (dBm)	DC Voltage Applied (V)	DC Current Typ (mA)
MPS-0030H16-XX	02	10-3000	14.5/16.0	0.50/0.80	2.0 / -	2.0 / -	-	27.0 / 25.5	33.5 / -	7.0-8.0	240-270
MPS-0325A9D-XX	82	300-2500	12.5/13.5	0.20/0.60	1.4 / 1.7	1.2 / 1.7	4.0 / -	25.0 / -	42.0 / 39.0	7.5	300-330
MPS-081017-XX	02	800-1000	15.0/14.0		2.0 / -	2.5 / -	-	28.5 / -	45.0 / 42.0	7.5	380-450
MPS-0810A9-XX	02	800-960	15.0/14.0		1.5 / -	2.0 / -	1.1 / 1.5	20.5 / -	34.0 / -	6.0	160-240
MPS-0810A9D-XX	82	800-960	14.0/13.0	0.20/0.30	1.4 / 1.5	1.2 / 1.5	5.0 / -	26.0 / 25.0	42.0 / 41.0	7.5	300-400
MPS-0820A9D-XX	02	800-2050	13.5/12.5		1.4 / -	1.4 / -	5.5 / -	24.0 / -	43.0 / -	6.0	220-280
MPS-093011-XX	82 , 85	800-1000	16.0/14.0	0.25/0.50	1.5 / -	2.2 / -	6.0 / -	30.0 / -	45.0 / 43.0	7.5	380-450
MPS-1720A9-XX	02	800-960	14.0/13.0		2.1 / 2.2	1.5 / 2.1	1.1 / 1.5	20.0 / -	33.0 / -	6.0	100-140
MPS-172208-XX	82 , 85	1900-2000	13.0/12.0	0.20/0.50	2.0 / 2.5	2.0 / 2.5	5.0 / -	26.0 / 25.0	38.0 / -	7.5	380-450
MPS-173011-XX	82 , 85	1400-1700	14.0/13.0	0.25/0.50	1.5 / -	2.2 / -	6.0 / -	30.0 / -	45.0 / 42.0	7.5	380-450
MPS-1820A9D-XX	82 , 02	1800-2000	14.0/13.0	0.20/0.30	1.4 / 1.5	1.2 / 1.5	5.0 / -	26.0 / 25.0	42.0 / 41.0	7.5	300-400
MPS-182117-XX	02	1800-2100	14.0/13.0		2.0 / -	2.5 / -	-	28.5 / -	45.0 / 42.0	7.5	380-450
MPS-182217-XX	82 , 02	1800-2200	14.0/13.0	0.25/0.50	1.5 / -	3.0 / -	6.0 / -	28.5 / -	45.0 / 42.0	7.5	380-450
MPS-2125A9D-XX	82 , 02	2100-2500	14.0/13.0	0.20/0.50	1.4 / 1.5	1.2 / 1.5	5.0 / -	26.0 / 25.0	42.0 / 41.0	7.5	300-400
MPS-213011-XX	82, 85, 02	1700-2100	14.0/13.0	0.25/0.50	1.5 / -	2.2 / -	6.0 / -	29.0 / -	45.0 / 42.0	7.5	380-450
MPS-242717-XX	02	2400-2700	13.0/12.0		2.0 / -	-	-	28.0 / -	45.0 / 42.0	6.0-7.0	380-450
MPS-253011-XX	02, 82 , 85	2400-2700	13.0/12.0	0.25/0.50	1.5 / -	2.2 / -	6.0 / -	29.0 / -	45.0 / 42.0	7.5	380-450
MPS-343517-XX	02 , 82	3400-3500	13.0/12.0	0.25/0.50	2.0 / -	2.2 / -	6.0 / -	29.0 / -	45.0 / 42.0	7.5	380-450
MPS-3435A9D-XX	82	3400-3500	13.0/12.0	0.20/0.30	1.4 / 1.5	1.3 / 1.5	6.0 / -	24.0 / 23.0	41.0 / 39.0	7.5	300-400
MPS-343617-XX	82	3400-3600	13.0/12.0		2.0 / -	2.2 / -	-	29.0 / -	48.0 / 44.0	7.5	350-420
MPS-343717-XX	02	3400-3700	12.5/11.7		1.5 / -	2.5 / -	-	28.5 / -	45.0 / 42.0	6.0-7.0	330-400
MPS-343717-XX	82	3400-3700	12.5/11.7		1.5 / -	2.5 / -	-	28.5 / -	45.0 / 42.0	6.7	380-450
MPS-363817-XX	82	3600-3800	13.0/12.0		2.0 / -	2.2 / -	-	29.0 / -	48.0 / 44.0	7.5	350-420

MPS, ULA, and MGA

General Purpose Hybrid Amplifiers in Surface Mount Packages

Model	Case Code (-XX) Sealed SMT, Flange	Case Code (-XX) Hermetic SMT	Freq Range (MHz)	Linear Gain Typ/Min (dB)	Gain Flatness Typ/Ma (±dB)	VSWR Input Typ/Min	VSWR Output Typ/Min	Noise Figure Typ/Min (dB)	Pout @ -1 dB Typ/Min (dBm)	PAE @ -1 Typ (%)	IP3 Typ/Min (dBm)	DC Voltage Applied (V)	DC Current Typ/Max (mA)
MPS-002701-XX	84	-	00-2700	11.5/10.5	0.5/0.8	2.0 / -	1.8 / -	6.0 / -	20.0 / 19.0	-	35.0 / -	5.0	120 / 160
MPS-003001-XX	84	87	20-3000	11.5/10.5	0.80/1.20	1.6 / 2.5	1.6 / 2.5	4.0* / -	21.0 / 19.0	30*	34.0 / -	5.0	90 / 160
MPS-013001-XX	84	-	100-3000	11.5/10.5	0.80/1.20	1.6 / 2.5	1.6 / 2.5	3.5*/5.0*	21.0 / 19.0	30	34.0 / -	5.0	90 / 160
MPS-032701A-XX	82	96	300-2700	20.0 / -	1.0 / -	2.0 / -	2.0 / -	5.0 / -	20.0 / 19.0	-	34.0 / -	5.0	320 / 360
MPS-0425A9D-XX	82	96	400-2500	14.0/13.0	-	1.4 / 1.7	1.2 / 1.7	-	25.0 / -	-	42.0 / -	7.5	300 / 330
MPS-082508-XX	82, 85	96	800-2500	13.0/11.0	0.50/1.00	2.0 / 2.5	2.0 / 2.5	5.0 / -	27.0 / 26.0	25	38.0/36.0	12.0	200 / 300
MPS-302201-XX	-	87	100-3000	11.5/10.5	0.50/0.80	1.6 / 2.5	1.6 / 2.5	3.5*/5.0*	22.0 / 20.5	30	35.0 / -	5.0	90 / 160
MPAM-206032-05	05	-	200-6000	26/-	1.2/-	1.6 / -	1.5 / -	5.5/-	32 / -	-	-	8/9	230 / 320

* NF - See Data Sheet

WiMAX Hybrid Amplifiers in Surface Mount Packages

Model	Case Code Sealed	Freq Range (MHz)	Linear Gain Typ/Min (dB)	Gain Flatness Typ/Ma (±dB)	VSWR Input Typ	VSWR Output Typ	P1dB Typ (dBm)	Pout @ 2.0% EVM Typ (dBm)	IP3 Typ/Min (dBm)	DC Voltage (V)	DC Current Typ/Max (mA)
WPS-242717-XX	02, 82	2450-2700	13.0	0.30/0.60	1.5	2.5	28.5	22.0	45.0	7.5	330
WPS-252717-XX	82	2500-2700	13.0	0.30/0.60	1.5	2.5	28.5	22.0 (1)	45.0	7.5	300
WPS-252724-XX	02, 99	2500-2700	14.0	0.30/0.60	1.5	2.5	36.0	29.0	50.0	8.5	1200
WPS-303322-XX	02	3000-3300	13.0	0.30/0.60	1.5	2.5	32.0	26.0 (1)	47.0	8.0	600
WPS-343617-XX	82	3400-3600	13.0	0.30/0.60	1.5	2.5	29.0	22.0 (1)	48.0	7.5	380-450
WPS-343717-XX	82	3400-3700	13.0	0.30/0.60	1.5	2.5	29.0	22.0 (1)	45.0	7.5	380-450
WPS-343722-XX	02	3400-3700	13.0	0.30/0.60	1.5	2.5	32.0	26.0 (1)	47.0	8.0	600
WPS-343724-XX	02, 99	3400-3700	14.0	0.30/0.60	1.5	2.5	36.0	29.0	50.0	8.0	1200
WPS-363817-XX	82	3600-3800	13.0	0.30/0.60	1.5	2.5	29.0	22.0 (1)	48.0	7.5	380-450
WPS-444922-XX	02	4400-4900	11.0	0.30/0.60	1.5	2.5	32.0	26.0	47.0	7.5	600
WPS-445122-XX	02	4400-5100	11.0	0.30/0.60	1.5	2.5	32.0	26.0	47.0	7.5	600
WPS-445124-XX	02	4400-5100	10/9	--	2.45	3.0	36 (2)	29.0	50.0	8.5	1200
WPS-495122-XX	02	4900-5100	11.0	0.30/0.60	1.5	2.5	32.0	26.0	47.0	7.5	600
WPS-495917-XX	02	4900-5900	13.0	0.30/0.60	1.5	2.5	28.5	22.0	44.0	7.5	300
WPS-495922-XX	02	4900-5900	11.0	0.30/0.60	1.5	2.5	32.0	26.0	47.0	7.5	600
WPS-545922-XX	02	5400-5900	11.0	0.30/0.60	1.5	2.5	32.0	26.0	47.0	7.5	600

(1) Pout @ 2.5% EVM (2) Pout @ -1dB

WiMAX Linear GaN Amplifiers

Model	Pkg/ Chip	Freq (GHz)	Linear Gain Typ/Min (dB)	Gain Flatness Typ/MAX (±dB)	Input RL Typ (dB)	Output RL Typ (dB)	Pout @ -3 dB Typ/Min (dBm)	Pout @ 2.5% EVM Typ (dBm)	Vdd (V)	DC Current (mA)
MGA-242740-02	02	2.4-2.7	14/12	1.0/1.5	8	8	40	33	28	50-400
MGA-333840-02	02	3.3-3.8	15/12	1.0/1.5	8	8	40	33	28	100-400
MGA-495940-02	02	4.9-5.9	12 / 10	1.0/1.5	8	8	40	33	28	100-400
MGA-444940-02	02	4.4-4.9	12 / 10	1.0/1.5	8	10	40	33	28	100-400
MGA-445343-99	99	4.4-5.3	14/12	1.0/1.5	7	4	43	35	28	150-300

Standard, Military, and Hi-Rel Connectorized Amplifiers



Standard, Military and

Wide-Band Amplifiers

Model Number	Freq Range (GHz)	Linear Gain Min/Typ (dB)	Gain Flatness Max (±dB)	Noise Figure Max/Typ (dB)	Pout -1 dB Min/Typ (dBm)	Current @12 V MAX * (mA)	Case Code
AW052202N	0.5-2	30/33	1.4	2.5/2.2	15/17	300	SL-2
AW052203	0.5-2	23/26	1.0	3.0/2.5	17/19	260	SL-2
AW054201N	0.5-4	19/26	1.0	2.5/2.2	15/17	220	SL-2
AW054203	0.5-4	21/24	1.0	4.5/4.0	16/18	260	SL-2
AW12201N	1-2	28/31	1.1	2.5/2.2	18/20	225	SL-2
AW12203	1-2	27/30	1.1	3.5/3.0	27/28	555	SL-2
AW26201N	2-6	21/23	1.0	2.5/2.2	13/15	155	SL-2
AW26204	2-6	19/21	1.0	4.5/4.0	23/24	335	SL-2
AW28201N	2-8	29/32	1.5	3.0/2.5	13/15	175	SL-2
AW28302	2-8	31/33	1.5	5.5/5.0	23/24	615	SL-3
AW612301N	6-12	30/32	1.0	3.5/3.0	16/17	240	SH-3
AW612304	6-12	22/23	1.0	6.5/6.0	27/28	750	SH-4
AW1218301N	12-18	24/26	0.8	3.5/3.0	14/15	230	SH-3
AW1218504	12-18	29/31	1.3	7.5/7.0	27/28	1200	SH-6
AW818301N	8-18	24/26	1.0	3.5/3.0	14/15	230	SH-3
AW818504	8-18	29/32	1.5	7.5/7.0	27/28	1300	SH-6
AW618301N	6-18	24/26	1.3	3.5/3.0	14/15	230	SH-3
AW618302	6-18	19/21	1.3	6.0/5.5	20/21	350	SH-3
AW618404	6-18	20/22	1.5	7.5/7.0	27/28	1200	SH-5
AW218201N	2-18	25/28	1.8	5.0/4.5	6/7	135	SH-2
AW218301N	2-18	24/26	2.0	6.5/6.0	15/16	365	SH-3
AW218301	2-18	20/22	2.0	6.0/5.5	20/21	500	SH-3

Temperature Compensation Amplifiers

Model Number	Freq Range GHz	Linear Gain MIN/TYP (dB)	Gain Flatness MAX (±dB)	Noise Figure MAX/TYP (dB)	Gain vs. Temp MAX (±dB)	Current @12 V MAX * (mA)	Case Code
AT26301	2-6	21/23	1.0	6.0/5.5	0.8	300	SL-3
AT26401	2-6	36/40	1.5	5.5/5.0	1.0	470	SL-4
AT618401	6-18	22/24	1.0	7.5/7.0	0.8	380	SH-4
AT618501	6-18	31/33	1.3	7.0/6.5	0.8	500	SH-5

Limiting Amplifiers

Model Number	Freq Range (GHz)	Pin Dynamic MIN/MAX (dBm)	Noise Power MAX (dBm)	Pout-sat MIN/MAX (dBm)	Pout MAX Flatness (±dB)	Current @12 V MAX * (mA)	Case Code
AL26501	2-6	-50/10	7.0	+15/+20	1.0	500	SL-5
AL618801	6-18	-50/10	10.0	+15/+20	2.0	800	LH-44

Contact factory for application assistance on custom and standard amplifiers. Hi-Rel and Space-Rel screening are available.
* Built in voltage regulator.

Standard, Military, and Hi-Rel Connectorized Amplifiers



Low Noise Amplifiers

Model Number	Freq Range GHz	Linear Gain MIN (dB)	Gain Flatness MAX (±dB)	Noise Figure MAX/TYP (dB)	Pout-1dB MIN/TYP (dBm)	Current @12 V MAX * (mA)	Case Code
AN12201N	1.2-1.8	28/31	0.5	-/1.7	15/17	180	CL-1
AN23201N	2.2-2.9	28/31	0.5	-/1.7	15/17	180	CL-1
AN45201N	4.4-5.0	25/27	0.5	-/1.7	15/17	180	CL-1
AN78201N	7.2-7.8	23/25	0.5	-/1.8	14/16	150	CH-1
AN910201N	9.0-10.0	21/23	0.5	-/1.8	14/16	150	CH-1
AN1415301N	14.5-15.3	24/27	0.5	-/2.1	13/15	200	CH-3
AN1718401N	17.7-18.7	29/32	1.0	-/2.8	12/14	250	CH-3

Medium Power Amplifiers

Model Number	Freq Range (GHz)	Linear Gain MIN (dB)	Gain Flatness MAX ±dB	VSWR MAX In/Out	Pout-1dB MIN/TYP (dBm)	Current @12 V MAX * (mA)	Case Code
AP45401	4.4-5.0	35.0	0.6	1.5/1.5	30.0/30.5	1400	CL-3
AP67402	5.9-6.4	33.0	0.6	1.5/1.5	33.0/33.5	2700	CL-3
AP78401	7.2-8.4	33.0	0.8	1.5/1.5	30.0/30.5	1450	CH-3
AP910401	9.0-10.0	32.0	0.8	1.5/1.5	30.0/30.5	1450	CH-3
AP1011401	10.7-11.7	27.0	0.8	1.5/1.5	30.0/30.5	1550	CH-3
AP1415401	14.0-14.5	23.0	0.5	1.5/1.5	29.0/30.0	1700	CH-3
AP1718501	17.7-18.7	24.0	1.0	1.8/1.8	26.0/27.0	1250	CH-5

Telecom Power Amplifiers

Model Number	Freq Range (GHz)	Linear Gain MIN (dB)	Gain Flatness MAX (±dB)	IMD3 (dBc) @ Po (dBm/Tone)	Pout-1dB MIN/TYP (dBm)	Current @12 V MAX * (mA)	Case Code
AP1819701	18.1-18.6	30	0.5	-50@+15	27	2300	PH-01
AP1819801	18.1-18.6	35	0.5	-54@+15	29	2700	PH-01

Contact factory for application assistance on custom and standard amplifiers. Hi-Rel and Space-Rel screening are available.

* Built in voltage regulator.

Hybrid Microwave Modules



Hybrid Microwave Modules

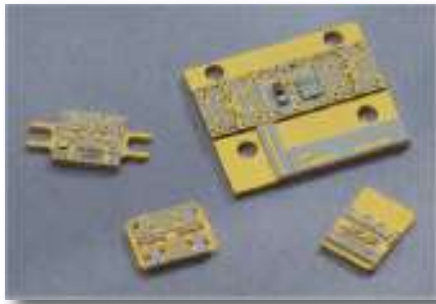

MwT Standard and Custom Hybrid Modules

Standard Gain Block Modules

Model	Freq Range (GHz)	Linear Gain Typ/Min (dB)	Gain Flatness Typ/Max (±dB)	VSWR: 1 In & Out Typ/Max	Reverse Isolation Typ (dB)	Noise Figure Typ (dB)	Pout @ -1 dB Typ/Min (dBm)	IP3 Typ	Current @ +8 V Typ/Max (mA)	Case Code	Carrier Size (mil x mil)
MwT 0206-11P2	2.0-6.0	6.0 / 5.0	0.4 / 0.6	1.7 / 2.0	-18.0	7.0	30.0 / 29.5	41.0	850 / 950	S/Z-1	300 • 600
MwT 0206-1G1	2.0-6.0	16.0 / 15.0	0.6 / 0.6	1.8 / 2.0	-30.0	4.5	17.0 / 16.0	27.0	150 / 180	U/L-1	300 • 600
MwT 0206-1G2	2.0-6.0	18.0 / 17.0	0.5 / 0.6	1.8 / 2.0	-30.0	3.5	19.0 / 18.0	29.0	150 / 200	U/L-1	300 • 600
MwT 0206-2P2	2.0-6.0	10.5 / 10.0	0.4 / 0.6	1.5 / 1.8	-20.0	4.5	24.5 / 24.0	35.0	220 / 260	S/Z-1	300 • 600
MwT 0206-7G2	2.0-6.0	11.0 / 10.5	0.4 / 0.6	1.5 / 1.8	-20.0	3.0	15.0 / 14.0	25.0	60 / 80	S/Z-1	300 • 600
MwT 0206-9P2	2.0-6.0	11.0 / 10.0	0.4 / 0.6	1.7 / 2.0	-20.0	4.0	26.0 / 25.0	37.0	260 / 290	S/Z-1	300 • 600
MwT 0206-A9G1	2.0-6.0	17.0 / 16.0	0.5 / 0.6	1.8 / 2.0	-30.0	1.5	15.0 / 14.0	25.0	50 / 55	S/Z-1	300 • 600
MwT 0206-A9N2	2.0-6.0	15.0 / 12.5	2.0 / 2.5	1.7 / 2.0	-17.0	1.0	15.0 / 13.0	25.0	50 / 70	S/Z-1	300 • 600
MwT 0618-2P1	6.0-18.0	5.0 / 4.5	0.4 / 0.6	1.5 / 1.7	-20.0	7.0	24.8 / 24.0	35.0	200 / 250	S/Z-2	250 • 500
MwT 0618-2P2	6.0-18.0	5.5 / 5.0	0.3 / 0.5	1.5 / 1.7	-20.0	7.0	25.5 / 24.5	36.0	220 / 275	S/Z-2	250 • 500
MwT 0618-3P1	6.0-18.0	6.0 / 5.0	0.4 / 0.6	1.5 / 1.7	-20.0	6.5	20.5 / 20.0	30.0	100 / 120	S/Z-2	250 • 500
MwT 0618-3P2	6.0-18.0	6.5 / 6.0	0.3 / 0.5	1.5 / 1.7	-20.0	6.5	21.5 / 21.0	31.0	100 / 120	S/Z-2	250 • 500
MwT 0618-4N1	6.0-18.0	7.5 / 7.0	0.4 / 0.6	1.5 / 1.7	-20.0	4.5	14.0 / 12.0	25.0	40 / 60	S/Z-2	250 • 500
MwT 0618-4N2	6.0-18.0	8.0 / 7.5	0.4 / 0.6	1.5 / 1.7	-20.0	4.0	14.0 / 11.0	25.0	40 / 60	S/Z-2	250 • 500
MwT 0618-H4N2	6.0-18.0	9.0 / 8.5	0.4 / 0.6	1.5 / 1.7	-20.0	3.0	10.0 / 7.0	20.0	40 / 60	S/Z-2	250 • 500
MwT 0618-5G1	6.0-18.0	10.0 / 9.5	0.4 / 0.6	1.5 / 1.7	-30.0	5.5	16.0 / 14.0	26.0	90 / 100	S/Z-2	250 • 500
MwT 0618-5G2	6.0-18.0	10.5 / 10.0	0.4 / 0.6	1.5 / 1.7	-30.0	5.0	18.0 / 15.5	28.0	100 / 120	S/Z-2	250 • 500
MwT 0618-7G2	6.0-18.0	7.5 / 7.0	0.4 / 0.6	1.5 / 1.7	-20.0	5.0	15.0 / 14.0	25.0	60 / 80	S/Z-2	250 • 500
MwT 0618-12P2	6.0-18.0	4.6 / 4.2	0.4 / 0.6	1.5 / 1.7	-20.0	7.5	27.5 / 27.0	38.0	350 / 450	S/Z-2	250 • 500
MwT 0618-H15P2	6.0-18.0	8.5 / 7.5	0.4 / 0.6	1.5 / 1.7	-20.0	7.5	27.0 / 26.0	34.0	250 / 275	S/Z-2	250 • 500
MwT 0618-H15P3	6.0-18.0	7.5 / 6.5	0.4 / 0.6	1.5 / 1.7	-20.0	7.5	29.0 / 28.0	36.0	250 / 300	S/Z-2	250 • 500
MwT 0618-H16P3	6.0-18.0	5.0 / 6.0	0.8 / 1.2	1.7 / 2.0	-17.0	8.0	30.0 / 29.0	38.0	450 / 550	S/Z-2	250 • 500
MwT 0618-H5G2	6.0-18.0	15.0 / 14.0	0.5 / 1.0	1.7 / 2.0	-17.0	3.0	20.0 / 17.0	29.0	80 / 120	S/Z-2	250 • 500
MwT 0618-H7P2	6.0-18.0	9.0 / 9.5	0.5 / 1.0	1.7 / 2.0	-17.0	5.5	21.0 / 24.0	33.0	110 / 150	S/Z-2	250 • 500
MwT 0820-3P1	8.0-20.0	5.0 / 4.5	0.4 / 0.6	1.5 / 1.7	-20.0	7.5	19.0 / 18.0	29.0	100 / 120	S/Z-2	250 • 500
MwT 0820-3P2	8.0-20.0	5.5 / 5.0	0.4 / 0.6	1.5 / 1.7	-20.0	7.0	20.0 / 19.0	29.0	100 / 120	S/Z-2	250 • 500
MwT 0820-4N1	8.0-20.0	6.0 / 5.5	0.4 / 0.6	1.5 / 1.7	-20.0	8.0	14.0 / 12.0	25.0	40 / 60	S/Z-2	250 • 500
MwT 0820-4N2	8.0-20.0	6.5 / 6.0	0.4 / 0.6	1.5 / 1.7	-20.0	4.0	14.0 / 11.0	25.0	40 / 60	S/Z-2	250 • 500
MwT 0820-5G1	8.0-20.0	9.0 / 8.0	0.4 / 0.6	1.5 / 1.7	-28.0	4.0	16.0 / 14.0	26.0	90 / 110	S/Z-2	250 • 500
MwT 0218-4N1	2.0-18.0	6.0 / 5.0	0.8	1.7 / 2.0	-20.0	7.0	15.0 / 14.0	25.0	100 / 120	S/Z-2	250 • 500
MwT 0218-4N2	2.0-18.0	6.5 / 6.0	1.2	1.7 / 2.0	-20.0	8.5	17.0 / 16.0	26.0	160 / 180	S/Z-2	250 • 500
MwT 0218-H4N1	2.0-18.0	12.0 / 11.0	0.8	1.7 / 2.0	-20.0	4.0	6.0 / 5.0	15.0	40 / 50	S/Z-2	250 • 500
MwT 0218-H4N2	2.0-18.0	11.0 / 10.0	0.8	1.7 / 2.0	-20.0	4.0	12.0 / 11.0	24.0	60 / 75	S/Z-2	250 • 500

Note: Typical 2nd Harmonics @ P-I -21.0 dBc Typ

Voltage Regulator Modules

Model	Freq Range (GHz)	Insertion Loss Typ/Max (dB)	Ripple Rej @ 120 Hz Min (dB)	Pw Diss Per VR Max (Watts)	Regulated Voltage Min/Max (V)	Supply Voltage Typ/Min (V)	Total Current Max (mA)	Case Code	Carrier Size (mil x mil)
MwT 0206-VRM	2.0-6.0	- / 0.5	50.0	1.5	7.9 / 8.1	12.0 / 20.0	800	U/L-1	300 • 600
MwT 0618-VRM	6.0-18.0	- / 1.0	50.0	1.5	7.9 / 8.1	12.0 / 20.0	800	U/L-2	250 • 500

MwT Standard Voltage Regulator Modules (Each Module Contains Dual Adjustable Voltage Regulators)

Temperature Compensation Modules

Model	Freq Range (GHz)	Insertion Loss Typ/Max (dB)	Loss Flatness ±Max (dB)	Attend. Typ/Min (dB)	Current @ +8 V Max (mA)	Case Code	Carrier Size (mil x mil)
MwT 0206-TCM	2.0-6.0	1.0 / 2.5	0.4 / 0.6	13.0 / 12.0	10 / 20	S/Z-1	300 • 600
MwT 0618-TCM	6.0-18.0	2.5 / 3.0	0.4 / 0.6	13.0 / 12.0	10 / 20	S/Z-2	250 • 500

MwT Standard Temperature Compensation Modules

Products to be Phased Out

Notification for Last Time Purchase for FET Devices from MwT's Own Fab and New FET Devices from Wafer Foundries

MicroWave Technology Inc. (MwT) has been a major GaAs linear MESFET and pHEMT device supplier to many customers in the past 30+ years for both military and commercial business. It is critical for MwT not only to maintain the discrete FET device business but also to continuously improve the device performance, consistency, and quality with competitive cost. These improvements include RF power, gain, power added efficiency, noise figure, and linearity over the appropriated frequency ranges. It is equally important to improve the consistencies for the device DC/RF parameters for tighter variations and better yield for customers' RF functional blocks using MwT devices, such as amplifiers and oscillators, etc. These goals can be achieved by MwT's deep knowledges on device physics, layout design, characterizations, qualifications and reliability, as well as device applications by using wafer foundries that are equipped with advanced fabrication equipment's and tools, tighter device process control, proven device reliability, and more accurate device models.

The following devices now use outside wafer foundries:

- pHEMT devices (0.25 um gate length): MwT-PH8, MwT-PH9 and PH-15
- High linearity devices: MwT-24,
- Low noise devices (0.15um gate length): MwT-LN180, MwT-LN240, MwT-LN300, MwT-LN600
- pHEMT device (0.25um gate length): MwT-PH4, MwT-PH5, MwT-PH7, MwT-PH11.
- High linearity devices (0.25um length): MwT-1, MwT-3, MwT-5, MwT-7 (same as MwT-S7, MwT-LP7), MwT-9 (same as MwT-A9), MwT-11

MwT will continue to sell existing inventory of Inside Foundry devices, until depleted.

MwT appreciates continuous support from its device customers for the discrete devices business.

Outline Drawings

(Dimensions in mm and inches – 1mm = 0.0394”)

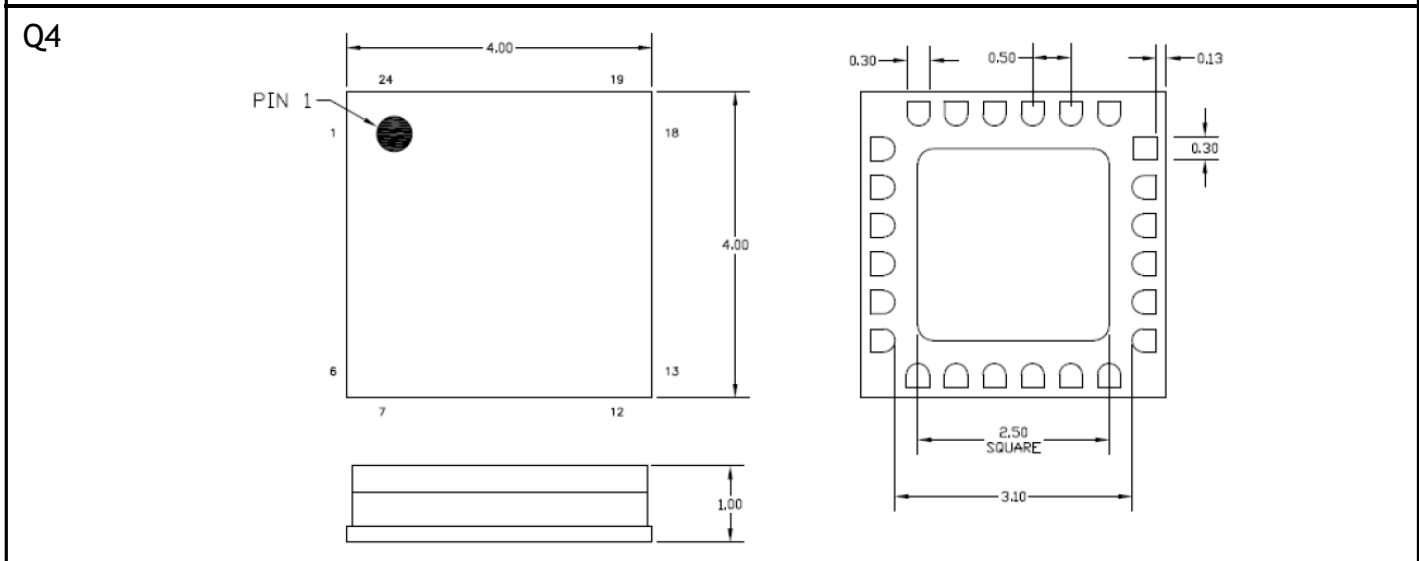
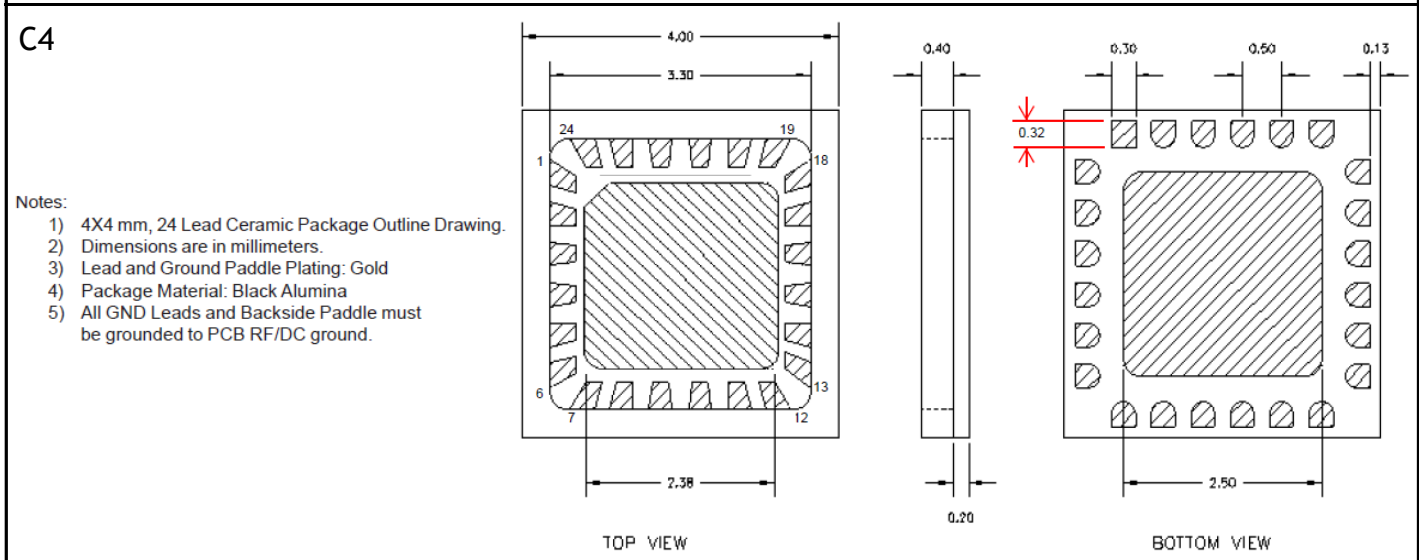
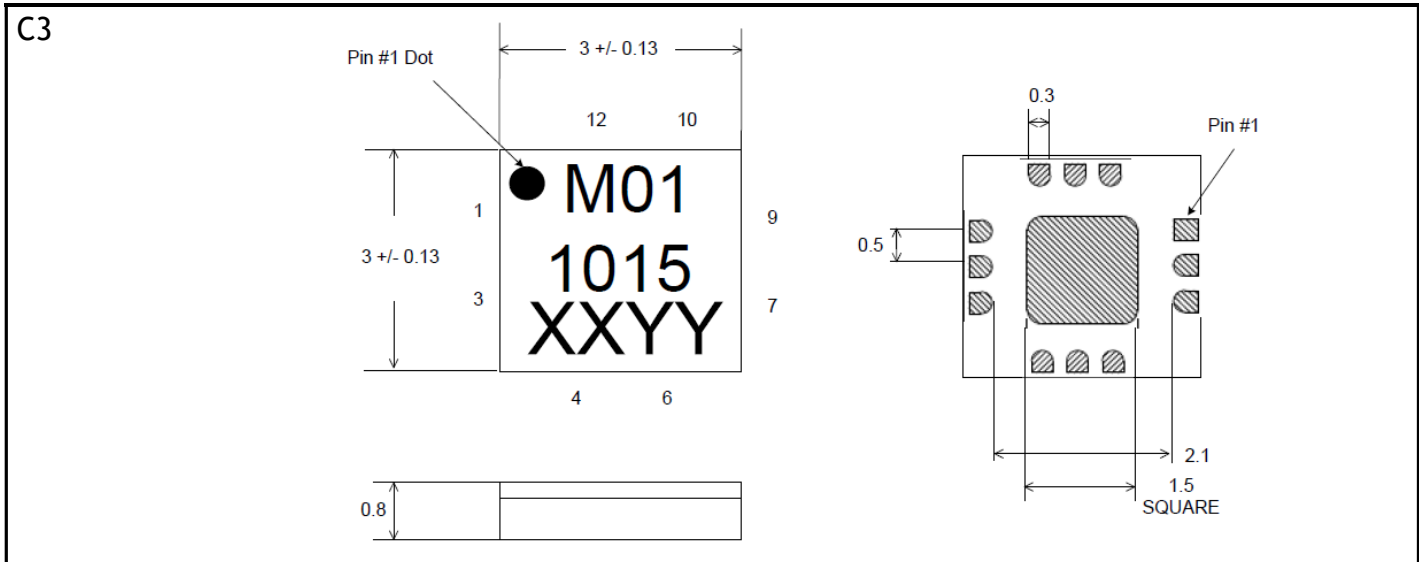

Outline Drawings

(Dimensions in mm and inches – 1mm = 0.0394”)

Q3

Gate : 2 & 3 (both required)
 Drain : 10 & 11 (both required)
 Source : Backside ground
 Ground Pad : 0.070" X 0.070" Typ.

H4

H7

M4

TOP VIEW BOTTOM VIEW

M5

Outline Drawings

(Dimensions in mm and inches – 1mm = 0.0394")

87

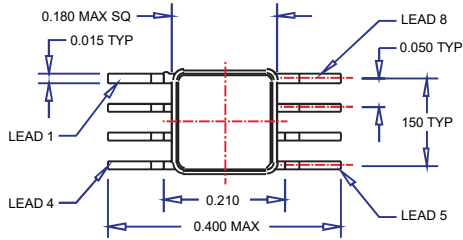

PIN DESCRIPTION PER SPECIFICATION SHEET

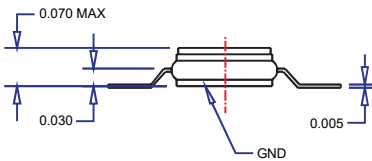

84

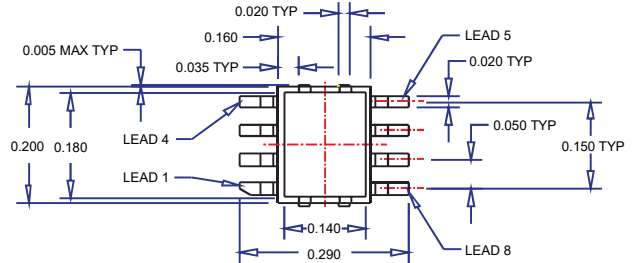

PIN DESCRIPTION PER SPECIFICATION SHEET

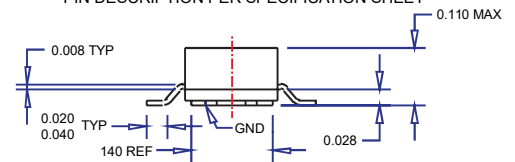

85

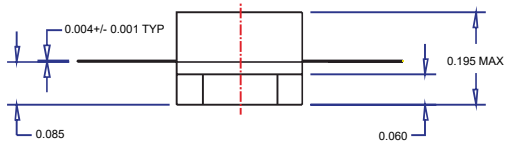
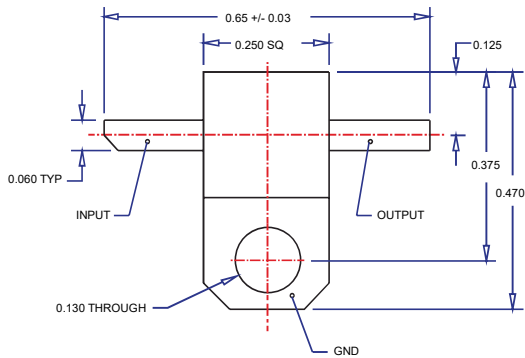

89
(SOT-89)

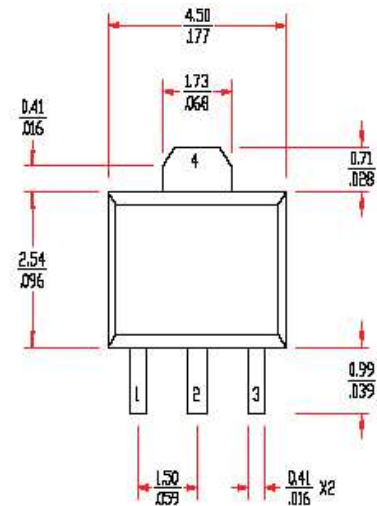

70

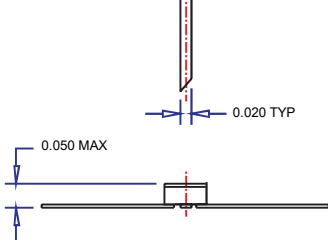
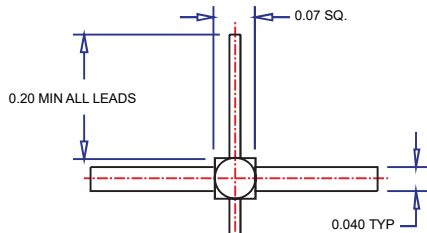

71

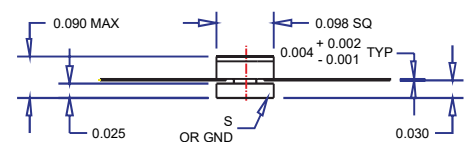
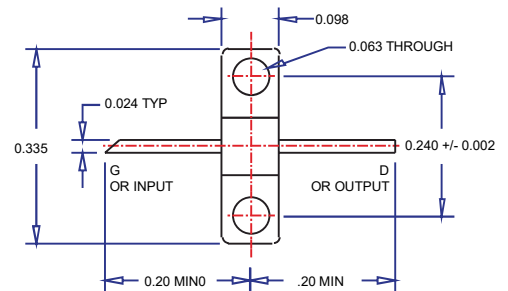

Outline Drawings

(Dimensions in mm and inches – 1mm = 0.0394")

73

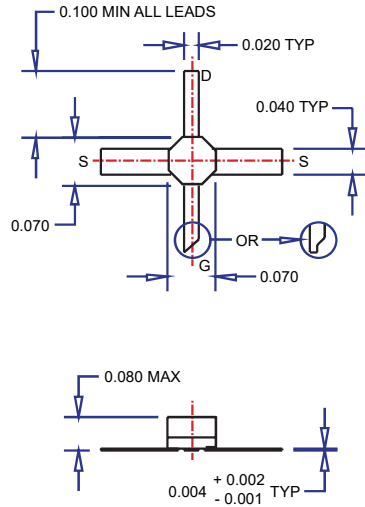

SZ-1

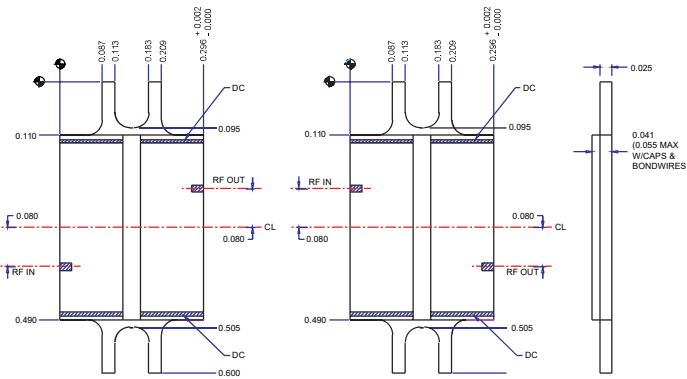

SZ-2

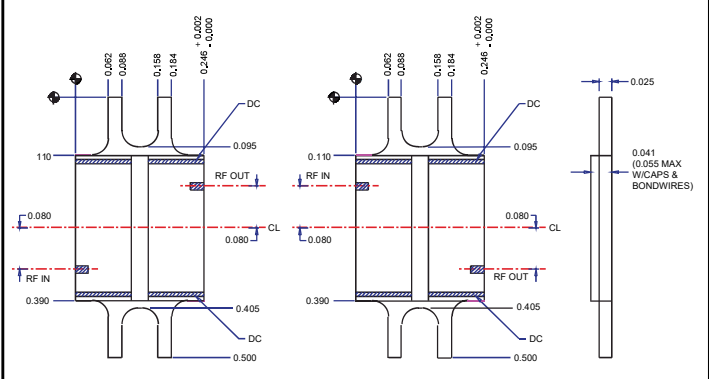

UL-1

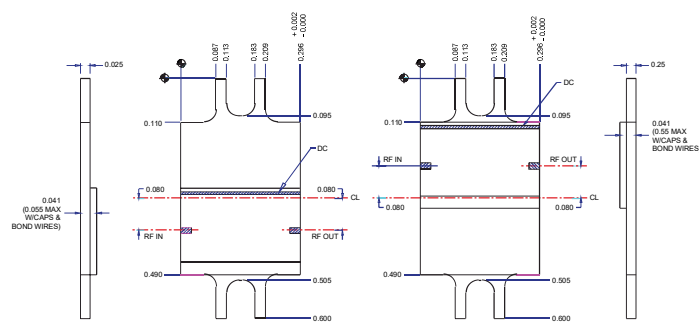

UL-2

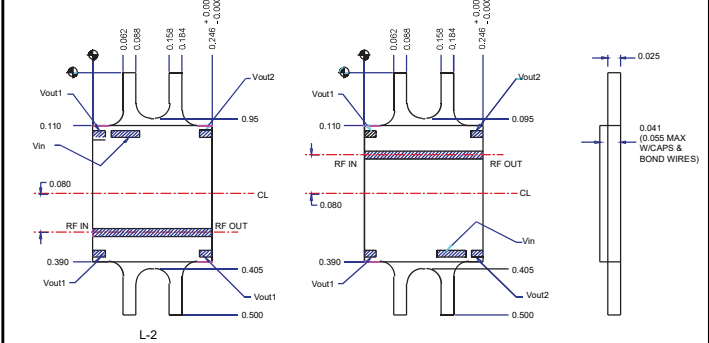

Outline Drawings

(Dimensions in mm and inches – 1mm = 0.0394”)

Slim-Pak*

SH & SL Housing Series
SMA Female, DC Filter Feedthru
Though Hole Mounting

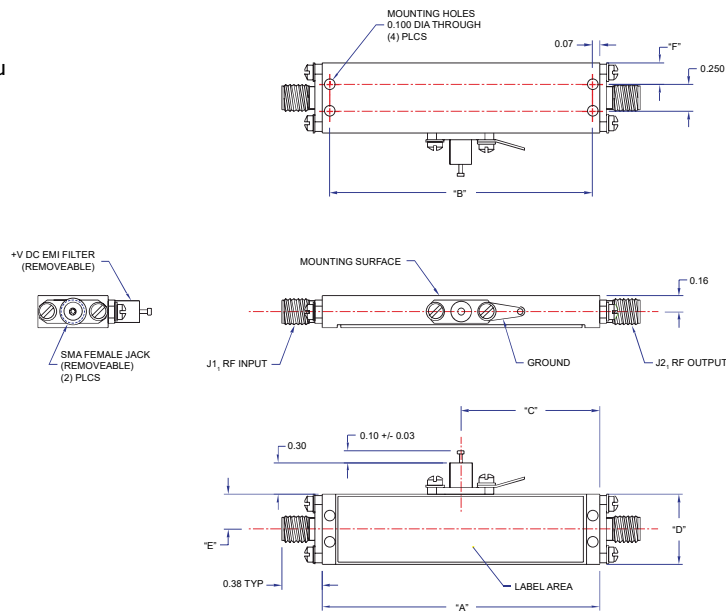

T-Pak*

TX & TC Housing Series
SMA Female, DC Filter Terminal
#4-40 Threaded Mounting Holes

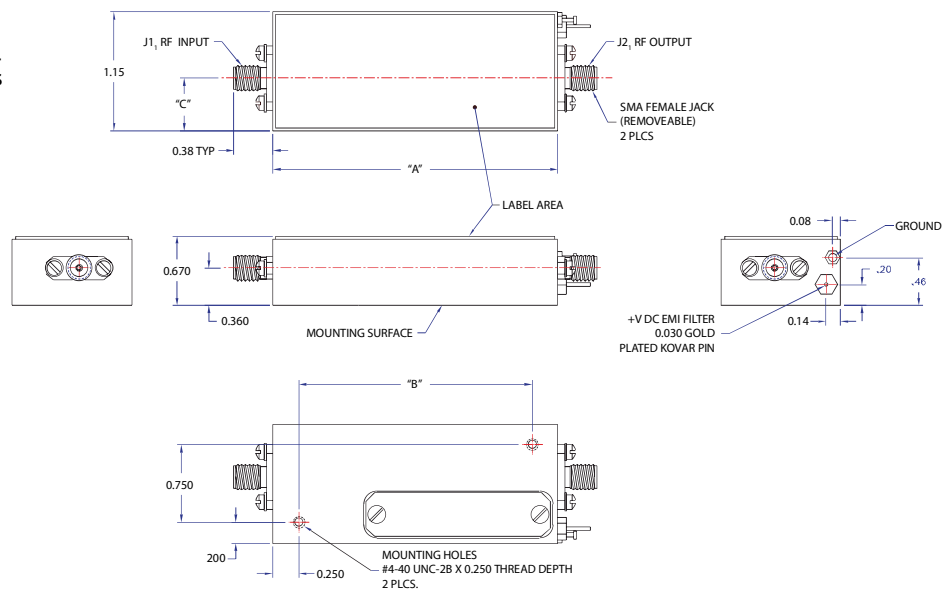

* Consult Factory for Package Options and Outline Drawings

Contact Information



MicroWave Technology Inc.

4268 Solar Way

Fremont, CA 94538

Phone: (510) 651-6700

Fax: (510) 952-4000

Website: www.mwtinc.com

sales@mwtinc.com

 **CERTIFICATE** 

This is to certify that

Microwave Technology Inc.
4268 Solar Way
Fremont, CA 94538
United States of America

has implemented and maintains a Quality Management System.

Scope:
The design and manufacture of standards and custom microwave products for wireless telecommunications, medical, and defense electronics applications.

Through an audit, documented in a report, it was verified that the management system fulfills the requirements of the following standard:

ISO 9001 : 2015

Certificate registration no. 10002374 QM 16
Date of original certification 2000-08-01
Date of certification 2018-07-10
Valid until 2021-07-09



DQS Inc.
Brad McClure
Brad McClure
Managing Director



Accredited Body: DQS Inc., 110 West Lake Cook Road, Suite 340, Buffalo Grove, IL 60089 USA



MwT Headquarters in Fremont, California, USA