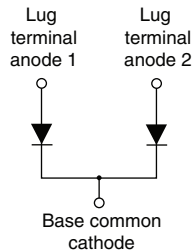

FRED Pt[®] Gen 5, Ultrafast Rectifier Diode, 600 V, 240 A

TO-244

FEATURES

- Ultrafast and optimized Q_{rr}
- Best in class forward voltage drop and switching losses trade off
- Optimized for high speed operation
- 175 °C maximum operation junction temperature
- UL approved file E222165
- Material categorization: for definitions of compliance please see www.vishay.com/doc?99912

BENEFITS

- Reduced RFI and EMI
- Higher frequency operation
- Reduced snubbing
- Reduced parts count

DESCRIPTION / APPLICATIONS

Featuring a unique combination of low conduction and switching losses the FRED Pt[®] Gen 5 is the right choice for soft switched and resonant converters, as well as medium frequency hard switching converters.

These devices are also ideally suited for HF welding, power converters, and other applications where switching losses are significant portion of the total losses.

PRIMARY CHARACTERISTICS

| | |
|-----------------------------------|---------------------------------------|
| $I_{F(AV)}$ at 95 °C (per module) | 240 A |
| V_R | 600 V |
| Q_{rr} (typical) | 260 nC |
| t_{rr} | 52 ns |
| Type | Modules - diode, FRED Pt [®] |
| Package | TO-244 |
| Circuit configuration | Two diodes common cathode |

ABSOLUTE MAXIMUM RATINGS

| PARAMETER | SYMBOL | TEST CONDITIONS | MAX. | UNITS |
|---|-------------|-----------------------|-------------|-------|
| Cathode to anode voltage | V_R | | 600 | V |
| Continuous forward current per diode | $I_{F(DC)}$ | $T_C = 25\text{ °C}$ | 229 | A |
| | | $T_C = 85\text{ °C}$ | 160 | |
| | | $T_C = 115\text{ °C}$ | 120 | |
| Non-repetitive single pulse forward current per diode | I_{FSM} | $T_C = 25\text{ °C}$ | 1300 | |
| Maximum power dissipation per diode | P_D | $T_C = 25\text{ °C}$ | 395 | W |
| | | $T_C = 115\text{ °C}$ | 158 | |
| Storage temperature range | T_{Stg} | | -40 to +150 | °C |
| Operating junction temperature range | T_J | | -40 to +175 | °C |

ELECTRICAL SPECIFICATIONS PER LEG ($T_J = 25\text{ °C}$ unless otherwise specified)

| PARAMETER | SYMBOL | TEST CONDITIONS | MIN. | TYP. | MAX. | UNITS |
|--------------------------------------|----------|---|------|------|------|-------|
| Breakdown voltage | V_{BR} | $I_R = 200\text{ }\mu\text{A}$ | 600 | - | - | V |
| Forward voltage | V_{FM} | $I_F = 120\text{ A}$ | - | 1.52 | 1.68 | |
| | | $I_F = 240\text{ A}$ | - | 1.67 | 1.96 | |
| | | $I_F = 120\text{ A}, T_J = 150\text{ °C}$ | - | 1.17 | - | |
| | | $I_F = 240\text{ A}, T_J = 150\text{ °C}$ | - | 1.46 | - | |
| Reverse leakage current | I_{RM} | $T_J = 150\text{ °C}, V_R = 600\text{ V}$ | - | 0.18 | 0.5 | mA |
| Series inductance | L_S | From top of terminal hole to mounting plane | - | 5 | - | nH |
| Maximum junction capacitance per leg | C_T | $V_{DC} = 5\text{ V}, f = 1\text{ MHz}, 25\text{ °C}$ | - | - | 0.7 | nF |

| DYNAMIC RECOVERY CHARACTERISTICS ($T_J = 25\text{ }^\circ\text{C}$ unless otherwise specified) | | | | | | | |
|---|-----------|-----------------------------------|---|------|------|------|-------|
| PARAMETER | SYMBOL | TEST CONDITIONS | | MIN. | TYP. | MAX. | UNITS |
| Reverse recovery time | t_{rr} | $T_J = 25\text{ }^\circ\text{C}$ | $I_F = 50\text{ A,}$ $di_F/dt = 200\text{ A}/\mu\text{s,}$ $V_R = 300\text{ V}$ | - | 52 | - | ns |
| | | $T_J = 125\text{ }^\circ\text{C}$ | | - | 135 | - | |
| Peak recovery current | I_{RRM} | $T_J = 25\text{ }^\circ\text{C}$ | | - | 4.0 | - | A |
| | | $T_J = 125\text{ }^\circ\text{C}$ | | - | 11.0 | - | |
| Reverse recovery charge | Q_{rr} | $T_J = 25\text{ }^\circ\text{C}$ | | - | 260 | - | nC |
| | | $T_J = 125\text{ }^\circ\text{C}$ | | - | 1530 | - | |

| THERMAL - MECHANICAL SPECIFICATIONS | | | | | | |
|---|------------|----------|------|----------|---|--|
| PARAMETER | SYMBOL | MIN. | TYP. | MAX. | UNITS | |
| Thermal resistance, junction to case | per leg | - | - | 0.38 | $^\circ\text{C}/\text{W}$ | |
| | per module | - | - | 0.19 | | |
| Thermal resistance, case to heatsink | R_{thCS} | - | 0.10 | - | | |
| Weight | | - | 68 | - | g | |
| | | - | 2.4 | - | oz. | |
| Mounting torque | | 30 (3.4) | - | 40 (4.6) | $\text{lbf} \cdot \text{in}$ ($\text{N} \cdot \text{m}$) | |
| Mounting torque center hole | | 12 (1.4) | - | 18 (2.1) | | |
| Terminal torque | | 30 (3.4) | - | 40 (4.6) | | |
| Vertical pull | | - | - | 80 | $\text{lbf} \cdot \text{in}$ | |
| 2" lever pull | | - | - | 35 | | |
| Case style | | TO-244 | | | | |

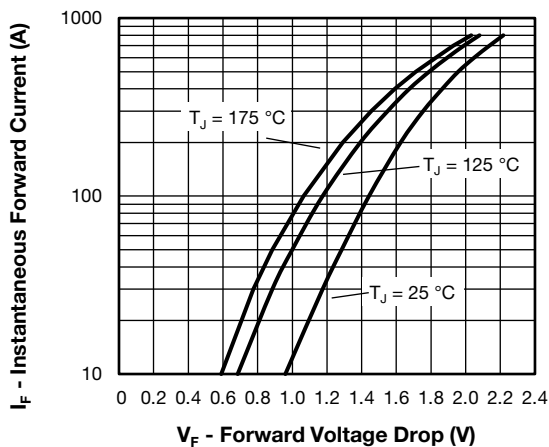

Fig. 1 - Typical Forward Voltage Drop vs. Instantaneous Forward Current (Per Diode)

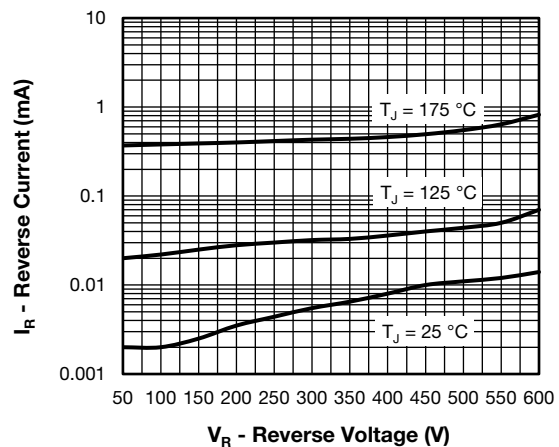

Fig. 2 - Typical Reverse Current vs. Reverse Voltage (Per Diode)

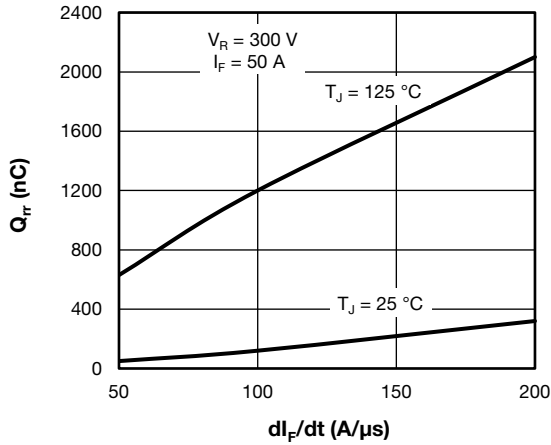

Fig. 3 - Typical Reverse Recovery Charge vs di_F/dt (Per Diode)

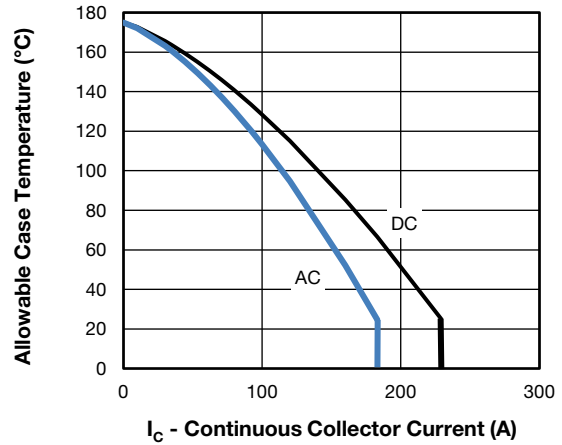

Fig. 6 - Maximum Continuous Forward Current vs. Case Temperature

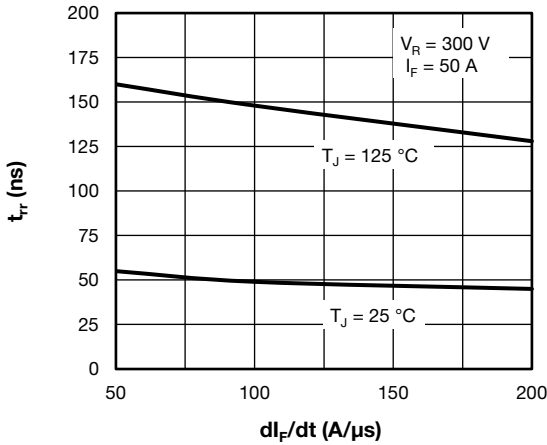

Fig. 4 - Typical Reverse Recovery Time vs di_F/dt (Per Diode)

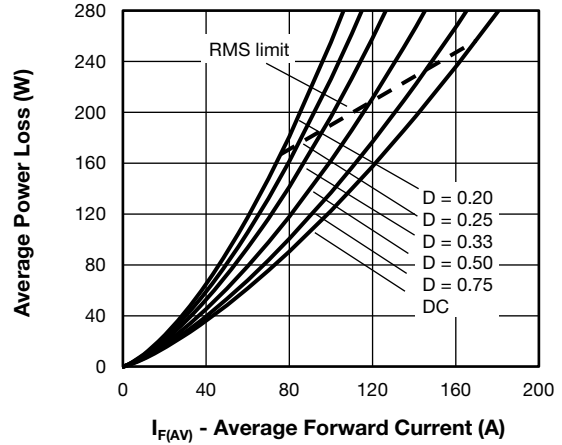

Fig. 7 - Average Power Loss vs. Average Forward Current (Forward Power Loss Characteristics)

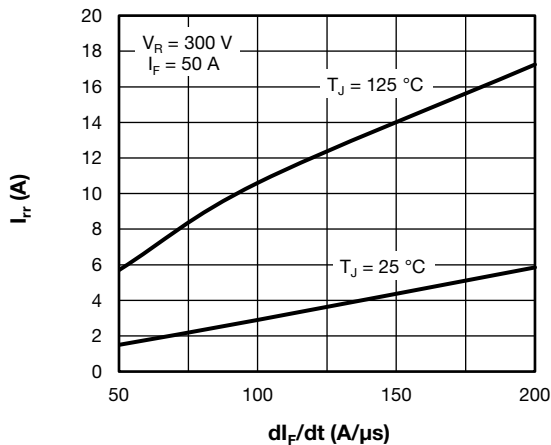

Fig. 5 - Typical Reverse Recovery Current vs di_F/dt (Per Diode)

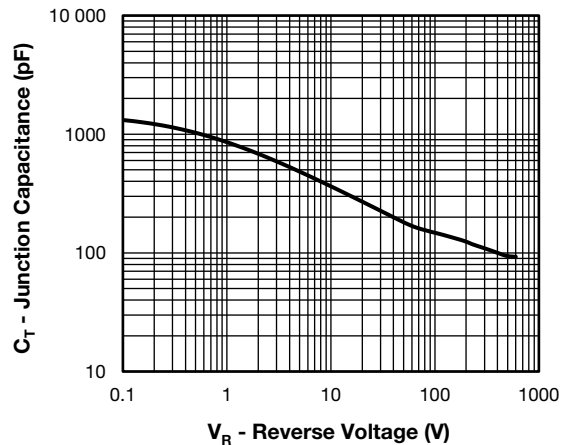
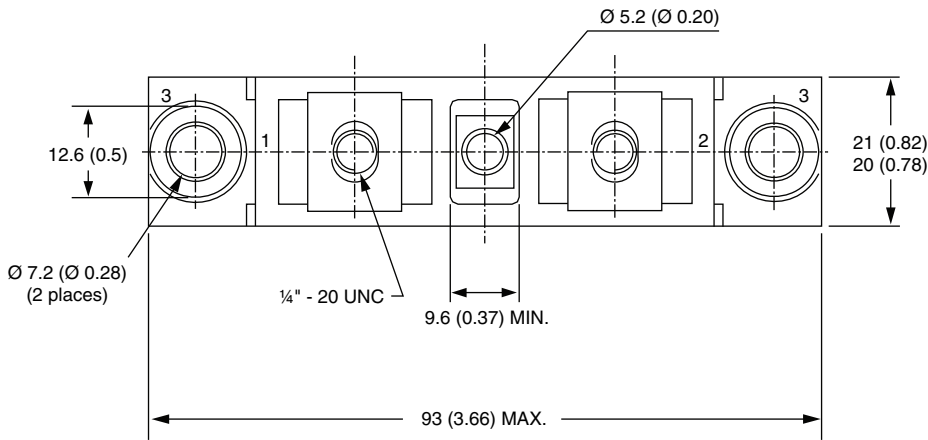
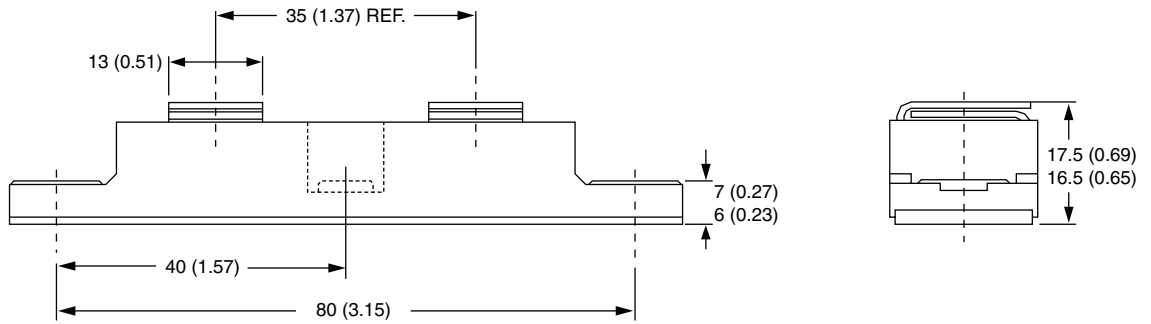

Fig. 8 - Typical Junction Capacitance vs. Reverse Voltage



DIMENSIONS in millimeters (inches)





Disclaimer

ALL PRODUCT, PRODUCT SPECIFICATIONS AND DATA ARE SUBJECT TO CHANGE WITHOUT NOTICE TO IMPROVE RELIABILITY, FUNCTION OR DESIGN OR OTHERWISE.

Vishay Intertechnology, Inc., its affiliates, agents, and employees, and all persons acting on its or their behalf (collectively, "Vishay"), disclaim any and all liability for any errors, inaccuracies or incompleteness contained in any datasheet or in any other disclosure relating to any product.

Vishay makes no warranty, representation or guarantee regarding the suitability of the products for any particular purpose or the continuing production of any product. To the maximum extent permitted by applicable law, Vishay disclaims (i) any and all liability arising out of the application or use of any product, (ii) any and all liability, including without limitation special, consequential or incidental damages, and (iii) any and all implied warranties, including warranties of fitness for particular purpose, non-infringement and merchantability.

Statements regarding the suitability of products for certain types of applications are based on Vishay's knowledge of typical requirements that are often placed on Vishay products in generic applications. Such statements are not binding statements about the suitability of products for a particular application. It is the customer's responsibility to validate that a particular product with the properties described in the product specification is suitable for use in a particular application. Parameters provided in datasheets and / or specifications may vary in different applications and performance may vary over time. All operating parameters, including typical parameters, must be validated for each customer application by the customer's technical experts. Product specifications do not expand or otherwise modify Vishay's terms and conditions of purchase, including but not limited to the warranty expressed therein.

Hyperlinks included in this datasheet may direct users to third-party websites. These links are provided as a convenience and for informational purposes only. Inclusion of these hyperlinks does not constitute an endorsement or an approval by Vishay of any of the products, services or opinions of the corporation, organization or individual associated with the third-party website. Vishay disclaims any and all liability and bears no responsibility for the accuracy, legality or content of the third-party website or for that of subsequent links.

Except as expressly indicated in writing, Vishay products are not designed for use in medical, life-saving, or life-sustaining applications or for any other application in which the failure of the Vishay product could result in personal injury or death. Customers using or selling Vishay products not expressly indicated for use in such applications do so at their own risk. Please contact authorized Vishay personnel to obtain written terms and conditions regarding products designed for such applications.

No license, express or implied, by estoppel or otherwise, to any intellectual property rights is granted by this document or by any conduct of Vishay. Product names and markings noted herein may be trademarks of their respective owners.