



RFM Integrated Device, Inc.

PRODUCT SPECIFICATION

Part Number: XTL2007

XTAL, 54 MHz, +/-3 ppm @
25C +/- 3C

Crystal Unit SMD 2.5x2.0 54.0MHz



Features:

- Surface Mount Hermetic Package
- Excellent Reliability Performance
- Good Frequency Perturbation and Stability over temperature
- Ultra Miniature Package
- Moisture Sensitivity Level (MSL) : Level-1

Description and Applications:

Surface mount 2.5mmx2.0mm crystal unit for use in wireless communications devices, especially for a need of ultra miniature package for mobility.

Electrical Specifications:

XTL2007	Specification
Nominal Frequency	54.000000 MHz
Mode of Oscillation	Fundamental
Storage Temperature Range	-40°C to +125°C
Operating Temperature Range	-40°C to +100°C
Frequency Stability over Operating Temperature Range	+/-14 ppm (referred to the value at 25°C)
Frequency Make Tolerance (FL)	+/-3 ppm @ 25°C +/- 3°C
Equivalent Series Resistance (ESR)	15 Ω max
Nominal Drive Level	100uW typical and 350uW max
Shunt Capacitance (Co)	3.0 pF max
Load Capacitance (CL)	15.5 pF
Aging	+/-1ppm/ year
Insulation Resistance	500 MΩ min./DC 100V
Marking	Laser Marking
Unit Weight	9.5 +/-0.5mg

Mechanical Dimensions (mm):

Base 1

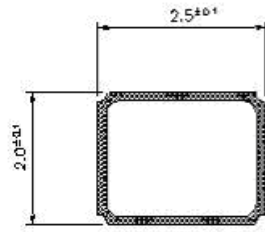

	Pin Connection
#1 pin	IN/OUT
#2 pin	GND
#3 pin	IN/OUT
#4 pin	GND

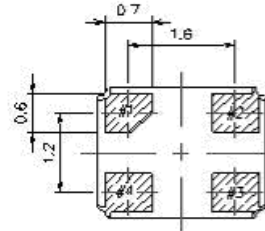
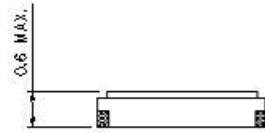

Internal Connections
(Top View)

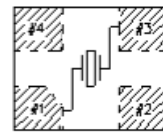

Base 2

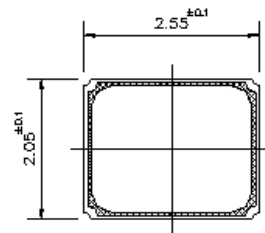

	Pin Connection
#1 pin	IN/OUT
#2 pin	GND
#3 pin	IN/OUT
#4 pin	GND

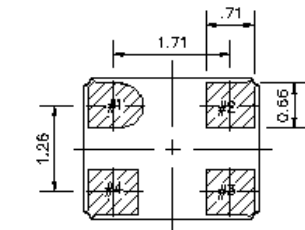
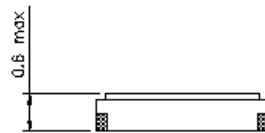

Connections
(Top View)

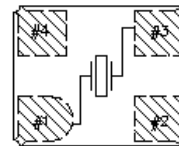

Recommended Land Pattern: (unit: mm)

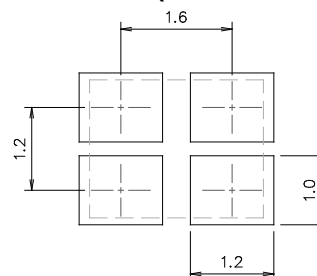

Marking:

Line 1: Frequency (54.0)

Line 2: Date Code + Product Code (internal tracking code, could be a~z and A~Z)

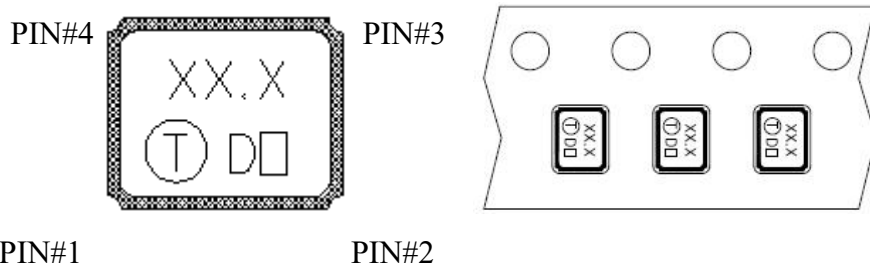

The inner vision of PIN#1, PIN#4 side is XTAL blank mounting pad.

Date Code Table

Date Code Table												
WK01	WK02	WK03	WK04	WK05	WK06	WK07	WK08	WK09	WK10	WK11	WK12	WK13
A	B	C	D	E	F	G	H	I	J	K	L	M
WK14	WK15	WK16	WK17	WK18	WK19	WK20	WK21	WK22	WK23	WK24	WK25	WK26
N	O	P	Q	R	S	T	U	V	W	X	Y	Z
WK27	WK28	WK29	WK30	WK31	WK32	WK33	WK34	WK35	WK36	WK37	WK38	WK39
a	b	c	d	e	f	g	h	i	j	k	l	m
WK40	WK41	WK42	WK43	WK44	WK45	WK46	WK47	WK48	WK49	WK50	WK51	WK52
n	o	p	q	r	s	t	u	v	w	x	y	z

Product Code Table: (Under line With Even Year and Odd Year for Nothing)

Year						Product Code
2013	2015	2017	2019	2021	2023	<input type="checkbox"/>
2014	2016	2018	2020	2022	2024	<input type="checkbox"/>

Reel Dimensions (mm):

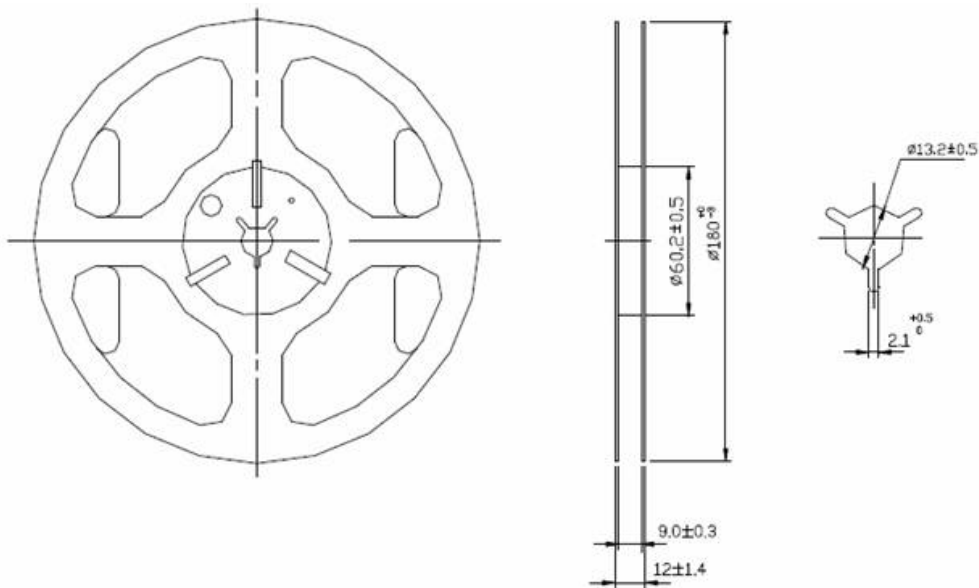

Tape Dimensions (mm):

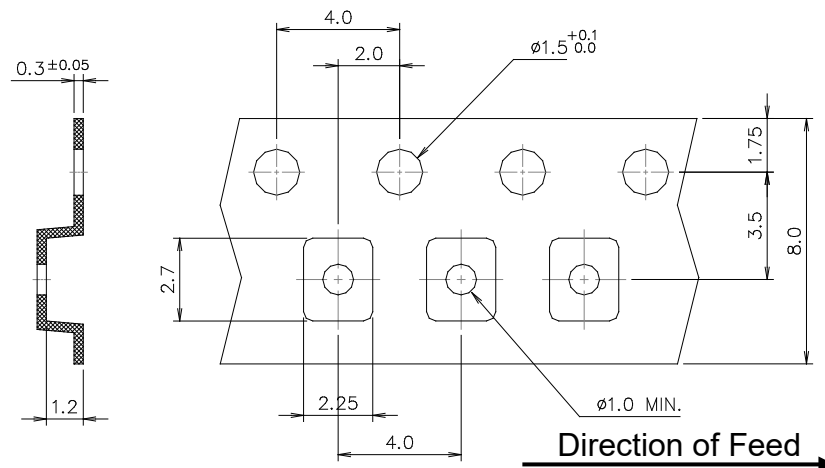

[NOTE]:

1. Unless otherwise specified tolerance on dimension ± 0.1 mm.
2. Material: conductive polystyrene with color black.
3. 10 pitch cumulative tolerance ± 0.2 mm.

Packing Quantity/Packing:

3K pcs maximum per reel

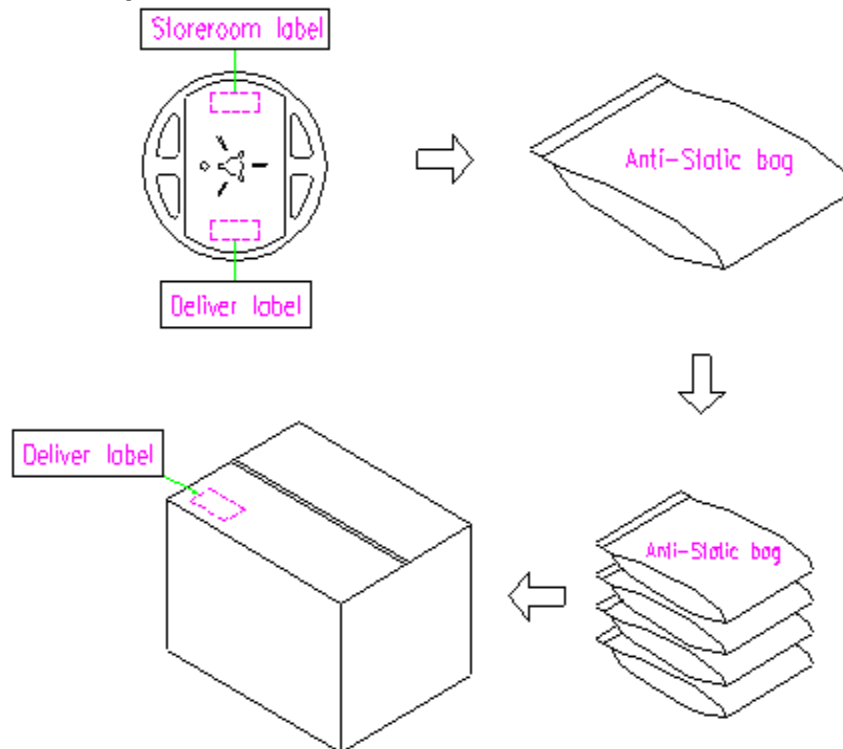

Reflow Profile:

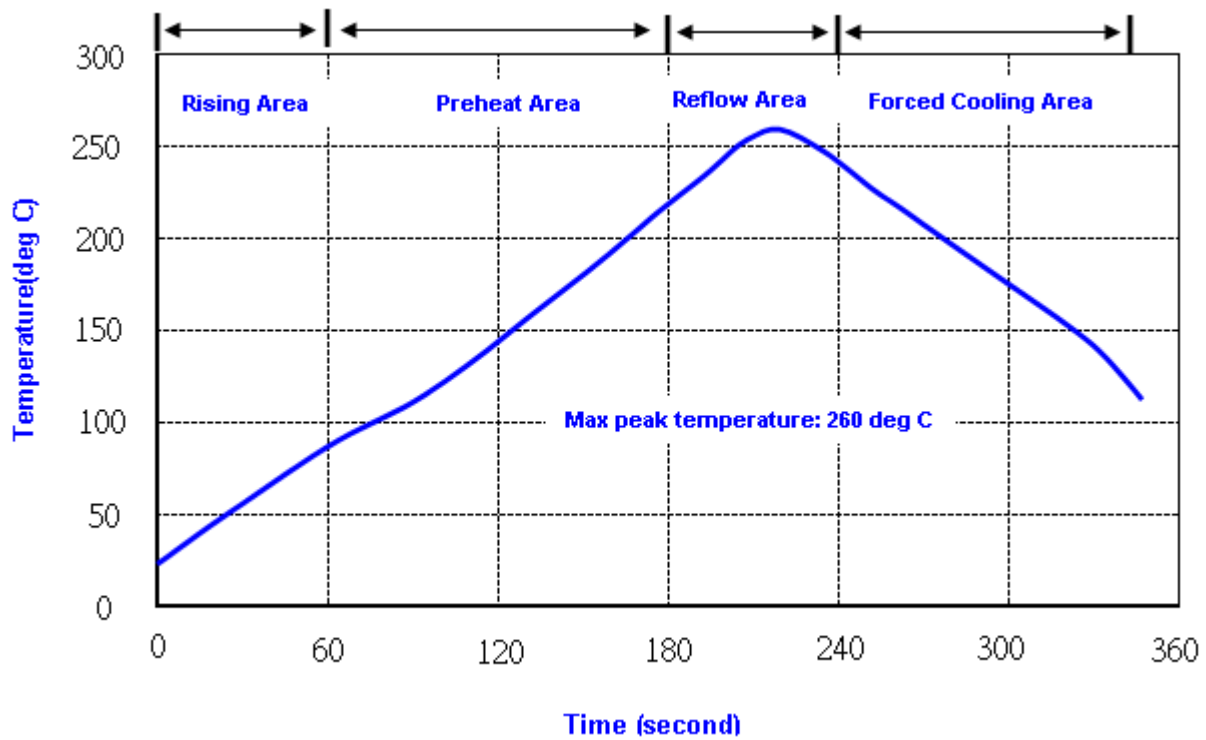

- Note: 1. Max peak temperature: 260 \pm 5 deg C; Time: 10 \pm 2 sec
2. Temperature: 217 \pm 5 deg C; Time: 90~100 sec

Reliability Specifications

Test name	Test process / method	Reference standard
Mechanical characteristics		
resistance to Soldering heat (IR reflow)	Temp./ Duration : 265°C /10sec ×2 times Total time : 4min.(IR-reflow)	EIAJED-4701 -300(301)M(II)
Vibration	Total peak amplitude : 1.5mm Vibration frequency : 10 to 2000 Hz Sweep period : 20 minute Vibration directions : 3 mutually perpendicular Duration : 2 hr / direc.	MIL-STD 202G method 204
Mechanical Shock	directions : 3 impacts per axis Acceleration : 3000g's, +20/-0 % Duration : 0.3 ms (total 18 shocks) Waveform : Half-sine	MIL-STD 202G method 213
Solderability	Solder Temperature:265±5°C Duration time: 5±0.5 seconds.	J-STD-002
Environmental characteristics		
Thermal Shock	Heat cycle conditions -40 °C (30min) ↔ 85 °C (30min) * cycle time : 10 times	MIL-STD 883G method 1010.8
Humidity test	Temperature : 85 ± 2 °C Relative humidity : 85% Duration : 96 hours	MIL-STD 202G method 103
Dry heat (Aging test)	Temperature : 125 ± 2 °C Duration : 168 hours	MIL-STD 202G method 108A
Cold resistance (Low Temp Storage)	Temperature : -40 ± 2 °C Duration : 96 hours	IEC 60068-2-1