

DIMENSIONS IN METRIC DO NOT SCALE DRAWING

EDP NO.

ENG. NO.
SD-53297-****

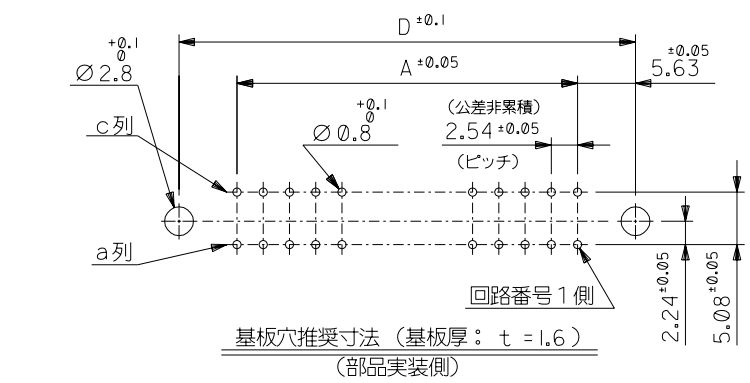
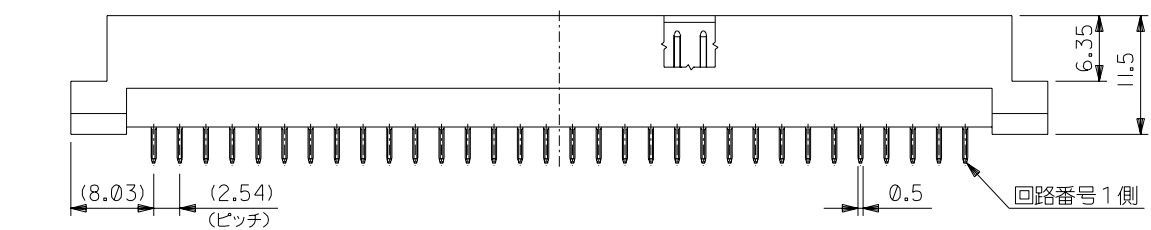
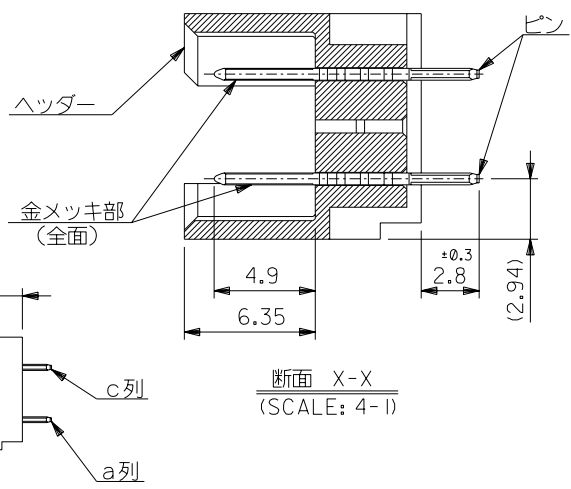
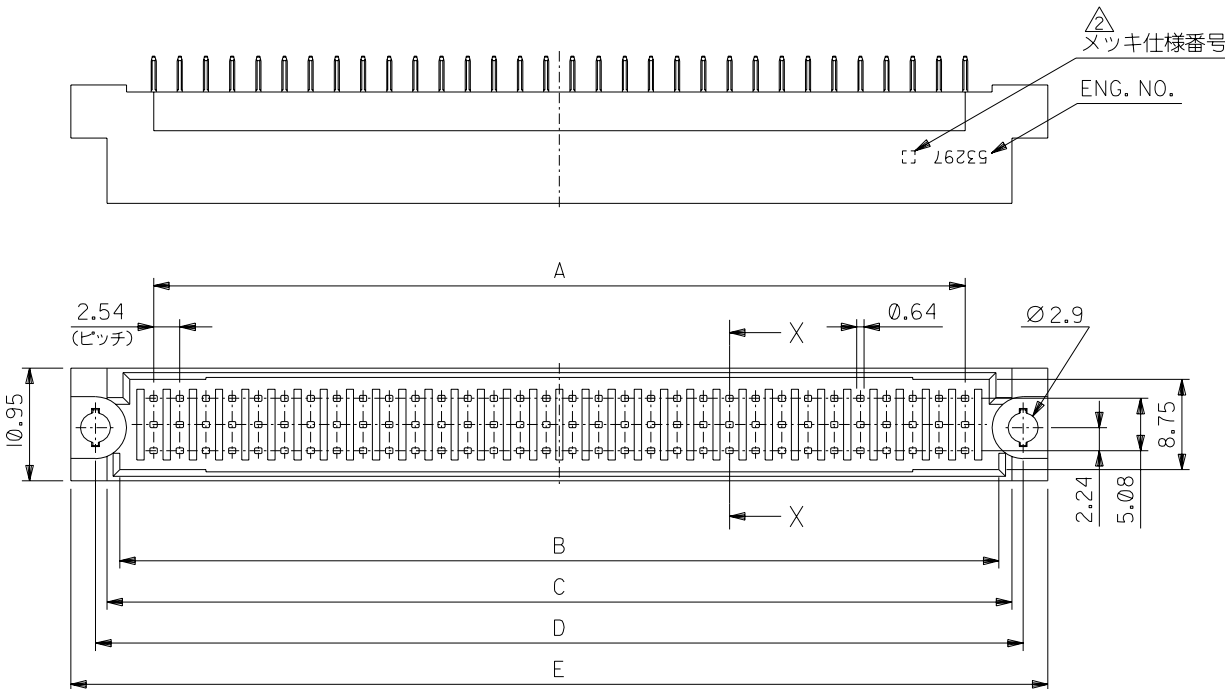

注記

- 1. 材質
 ヘッダー : ガラス入り P.B.T.(白色), UL94V-0
 ピン : 黄銅 (t=0.58)
- 2. メッキ仕様及び仕様番号

53297-***3	0.76	1.0	1.0	3
53297-***2	0.5			2
53297-***1	0.3			1
53297-***0	0.1			0
ENG. NO.	接点部 金メッキ [μm 以上]	半田付け部 半田メッキ [μm 以上]	下地メッキ ニッケルメッキ [μm 以上]	メッキ 仕様番号

3. 嵌合相手: 52379, 52481 シリーズ

94.8	90	87.8	85.3	78.74	53297-064*	96	64
54.16	49.36	47.16	44.66	38.1	53297-032*	48	32
E	D	C	B	A	ENG. NO.	ヘッダー の極数	極数

角度 ANGLE		±3°	B 変更 (J2004-1550)	K.S	03/12/15	材料 MATERIAL		注記参照		MOLEX-JAPAN CO.,LTD. 日本モレックス株式会社	
30°以上 OVER		+0.3	A 変更 (J10138)	H.H	03/12/20	仕上げ FINISH		注記参照		EDP NO.	
10°以上 OVER 30°未満 UNDER		+0.25	0 新規作成 (J00981)	H.H	09/09/13	適用電線範囲 WIRE RANGE		---		ENG. NO.	
10°未満 UNDER		+0.2	TR 変更内容 REVISION RECORD	DR. CHK.	日付 DATE	被覆外径 INS. RANGE		---		SD-53297-****	
一般公差 GENERAL TOLERANCES		REVISE ONLY ON CAD SYSTEM				DRAWN BY '90/9/8 H.HIRAMOTO		CHK'D BY		TITLE 名称 2.54 B TO B CONN. STRAIGHT HEADER ASS'Y (DUAL ROW)	
						APP'D BY		尺度 SCALE 2 - 1		REV B	

DIMENSIONS IN METRIC DO NOT SCALE DRAWING

EDP NO.

ENG. NO. SD-53297-****

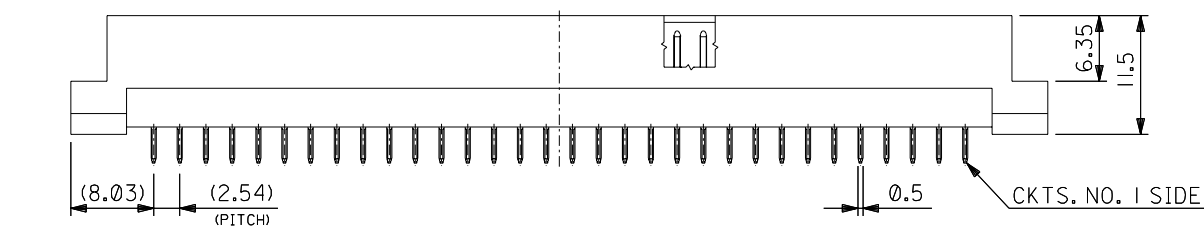
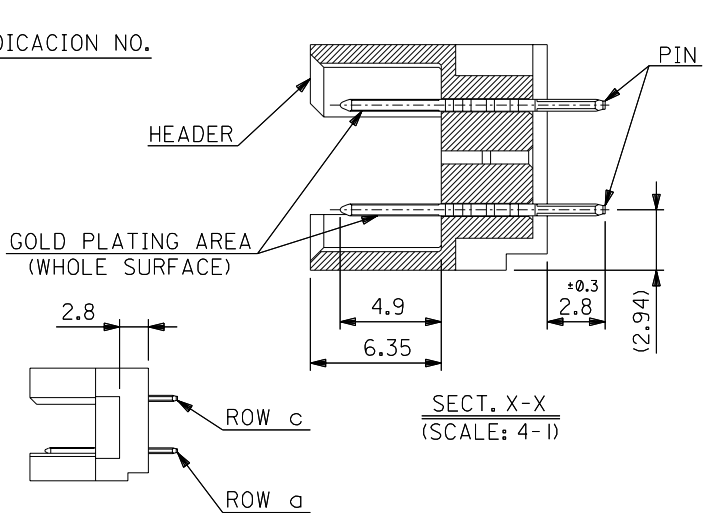
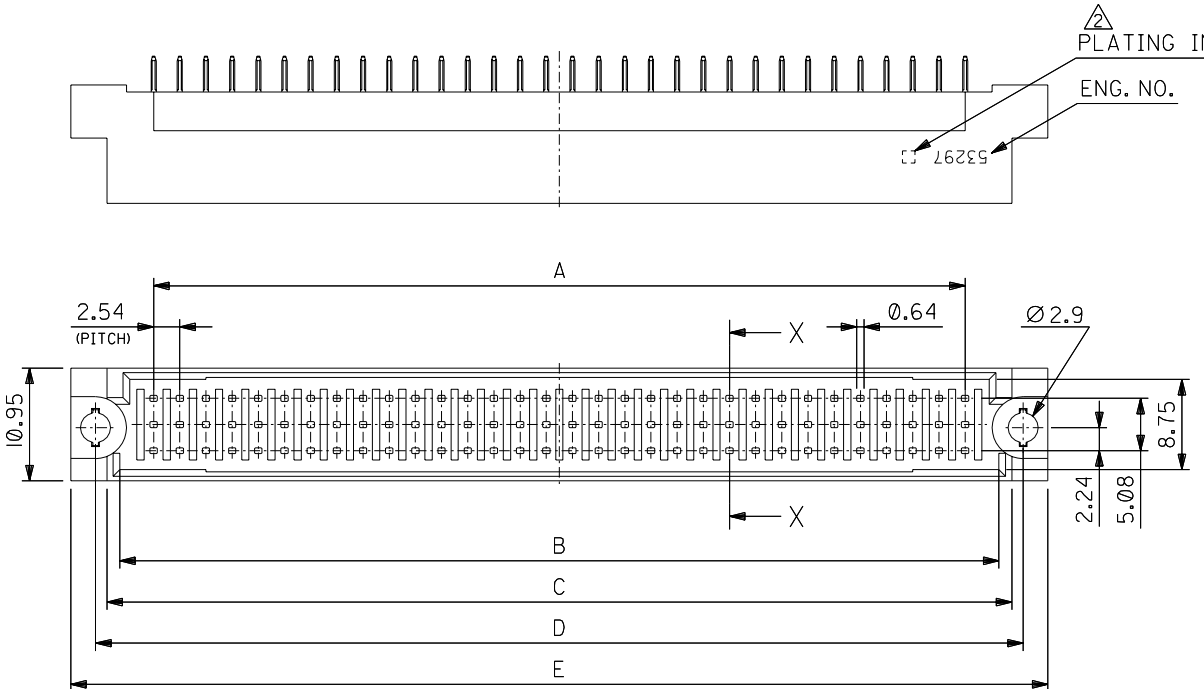

NOTES:

- 1. MATERIAL
 HEADER: GLASS FILLED P.B.T. (WHITE), UL94V-0
 PIN: BRASS (t=0.58)

△ PLATING & PLATING INDICATION NUMBER

53297-***3	0.76	1.0	1.0	3
53297-***2	0.5			2
53297-***1	0.3			1
53297-***0	0.1			0
ENG. NO.	CONTACT AREA GOLD [μmMIN.]	SOLDER AREA TIN-LEAD [μmMIN.]	UNDER PLATE NICKEL [μmMIN.]	PLATING INDICATION NUMBER

3. MATE WITH : 52379, 52481 SERIES.

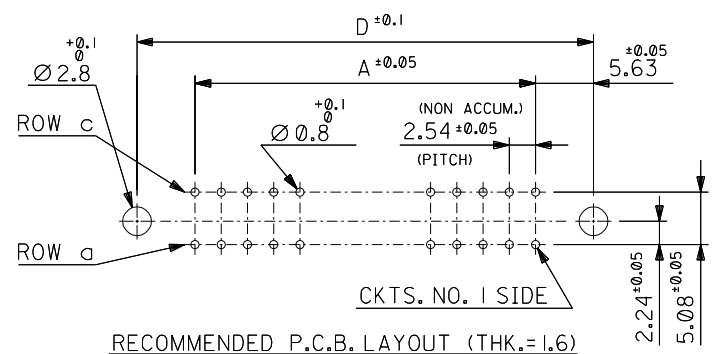

RECOMMENDED P.C.B. LAYOUT (THK_s=1.6)
(VIEW ON COMPONENT SIDE)

94.8	90	87.8	85.3	78.74	53297-064*	96	64
54.16	49.36	47.16	44.66	38.1	53297-032*	48	32
E	D	C	B	A	ENG. NO.	NO. OF CKTS. FOR HEADER	NO. OF CKTS.

角度 ANGLE		±3°	B	REVISD(J2004-1550)	K.S	03/12/15	材料 MATERIAL		SEE NOTES		molex MOLEX-JAPAN CO.,LTD. 日本モレックス株式会社	
30 以上 OVER		+0.3	A	REVISD (J10138)	H.H	9/12/20	仕上げ FINISH		SEE NOTES		EDP NO.	
10 以上 OVER 30 未満 UNDER		+0.25	0	RELEASED(J00981)	H.H	90/9/13	適用電線範囲 WIRE RANGE		---		ENG. NO.	
10 未満 UNDER		+0.2			H.Y		被覆外径 INS. RANGE		---		SD-53297-****	
一般公差 GENERAL TOLERANCES				REVISION RECORD	DR. CHK.	日付 DATE	DRAWN BY '90/9/8 H.HIRAMOTO		CHK'D BY		TITLE 名称 2.54 B TO B CONN. STRAIGHT HEADER ASS'Y (DUAL ROW)	
							APP'D BY		尺度 SCALE 2 - 1		REV B	

THIS DRAWING CONTAINS INFORMATION THAT IS PROPRIETARY TO MOLEX(JAPAN) AND SHOULD NOT BE USED WITHOUT WRITTEN PERMISSION
 本図面は日本モレックス(株)の所有する情報を含みますので 当社の許可なく複製を禁止する。