

Technical Characteristics

Part Number

Han 3A Kit

Hood	Top Entry
Housing	Bulkhead
Hood/Housing Material	Plastic
IP / NEMA	IP65 / 4, 4x, 12
Temp Rating	-40 to +125C
Cable Gland	M20 Plastic
Cable Diameter	5-9mm / 6-12mm
Insert	3+GND
Screw Terminals	18-14AWG
Wire Strip Length	4.5mm
Mating Cycles	> 500
Flammability	V-0

10 20 003 0002



Electrical Characteristics

Rated Current	10amps
Rated Voltage	600V UL
Rated Impulse Voltage	4kV

Drawings and Assembly Information

Dimensions in mm

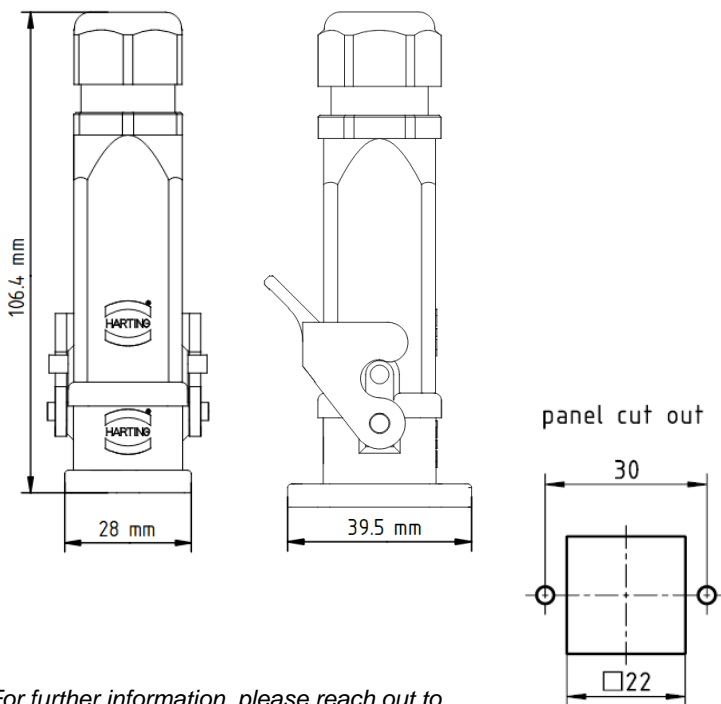

Tooling and Torque Values

Type	Tool	Torque (Nm)
Terminal Screws (M3)	Slotted 0.4 x 2.5	0.25
Fixing Screw (M3)	Slotted 0.4 x 2.5	0.25
Mounting Screws (M3 recommended)	-	0.8...1.0
Cable Gland (M20)	SW 24	4.5

Kit Contents

Male Insert	09 20 003 2611
Female insert	09 20 003 2711
Housing	09 20 003 0320
Hood	19 20 003 0420
Cable Gland*	19 00 000 5180 (5-9mm)
	19 00 000 5182 (6-12mm)
Screws (x2)	09 20 000 9918

For further information, please reach out to techsupportUS@HARTING.com

*kit content include one gland with multiple grommets