

REV.	ECN NO.	DESCRIPTION	SIGN	DATE
C1	N/A	INITIAL DRAWING	Liu	2020/05/16

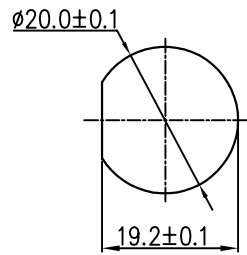

Recommended Panel Cut-Out

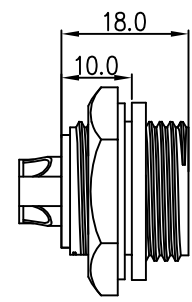

Panel T: Max 3.5mm

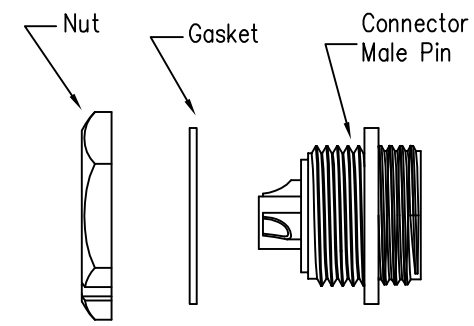
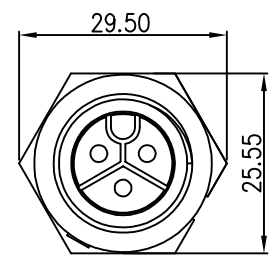
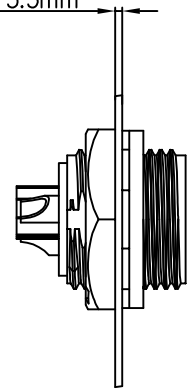

23XXX515-03  
Pin Number

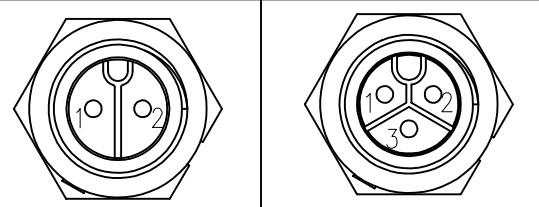

2 Pin

3 Pin

P/N: 23002515-03

P/N: 23003515-03

Pin Assignments Front View

Specification:

- 1.Operation Temperature: -45°C~105°C.
- 2.Insulation Resistance: 100MΩ at DC500V.
- 3.Contact Resistance: <math>< 10\text{m}\Omega</math>
- 4.Withstand Voltage: 2000V AC
- 5.Operating Current: 20A
- 6.Operating Voltage: AC 300V
- 7.Waterproof Rate: IP67 (Mated)
- 8.Housing: Nylon, Black
- 9.Male Pin: Copper Alloy, Gold Plated
- 10.Gasket: Silicon Gray
- 11.Panel Nut: Nylon, Black
- 12.Torque Rate: 0.8~1.0N · m
- 13.RoHS Compliant.
- 14.UL Compliant.
- 15.Mating Cap P/N: 806-00021-00

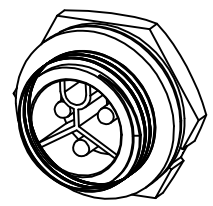

**CHOGORI**

UNIT:mm		DESCRIPTION	Middle Series Screw Type Rear Mount With Male Pin	PART NO	23XXX515-03	DRAWN BY	Liu	DATE	2020/05/16
TOLERANCE	.X ±0.25 .XX ±0.15 .XXX ±0.05 ANGLES ±1°	SCALE	1:1	SHEET	1 OF 1	CHECKED BY	Mo	DATE	2020/05/16
REV.	C1	SIZE	A4	* : Inspection Item		APPROVED BY	Adley	DATE	2020/05/16

THIS INFORMATION IS CONFIDENTIAL AND IS DISCLOSED TO YOU ON CONDITION THAT NO FURTHER DISCLOSURE IS MADE BY YOU TO OTHER THAN CHOGORI PERSONNEL WITHOUT AUTHORIZATION FROM CHOGORI CORP.