

REVISIONS

P	LTR	DESCRIPTION	DATE	DWN	APVD
	BA	NEW RELEASE	23-MAR-10	MRS	St.P
	BB	CLARIFICATION OF DIMENSIONS	18JAN2023	DM	AP

FOR FURTHER INFORMATION SEE DATA SHEET FOR SERIES LR. METAL FILM FIXED RESISTORS

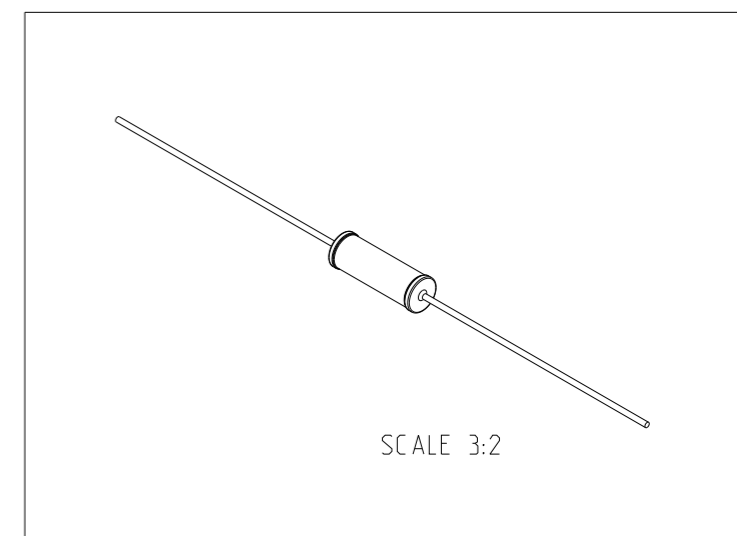
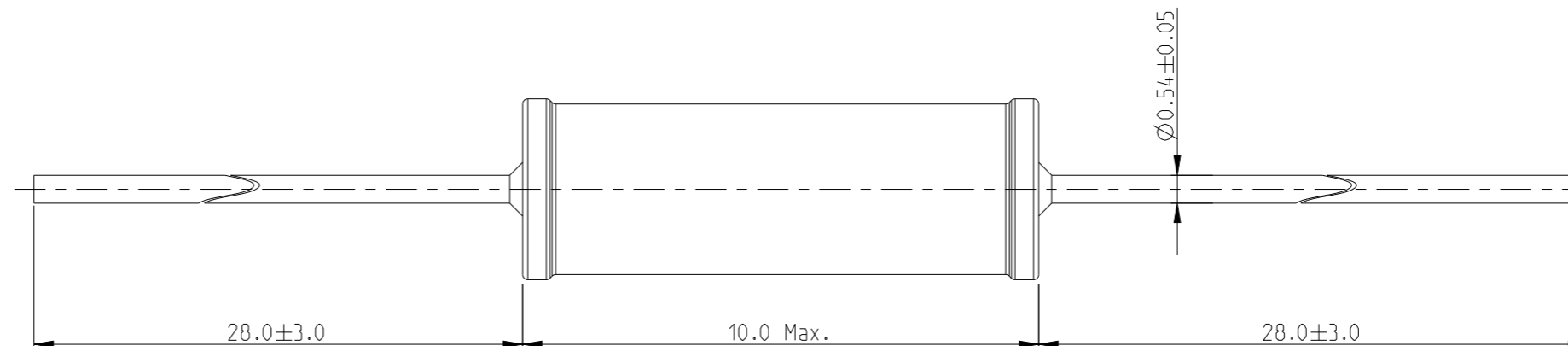
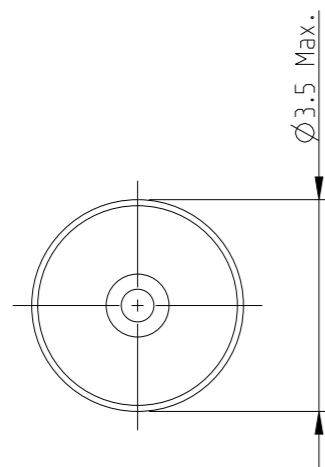

RoHS Compliant

THIS DRAWING IS A CONTROLLED DOCUMENT.

DIMENSIONS: mm	TOLERANCES UNLESS OTHERWISE SPECIFIED:
	0 PLC ± 0.2 1 PLC ± 0.1 2 PLC \pm 3 PLC \pm 4 PLC \pm ANGLES $\pm 5^\circ$
MATERIAL -	FINISH -

DWN	23-MAR-10
MAHARUDRA	
CHK	23-MAR-10
ALLAN.P	
APVD	23-MAR-10
STEPHEN.P	
PRODUCT SPEC	-
APPLICATION SPEC	-
WEIGHT	-
CUSTOMER DRAWING	

		NAME		RESTRICTED TO
		METAL FILM FIXED RESISTORS SERIES LR2		
SIZE	CAGE CODE	DRAWING NO	-	
A3	00779	C-1622723	-	
SCALE	SHEET	OF	REV	
8:1	1	1	BB	