

EM-93424-010

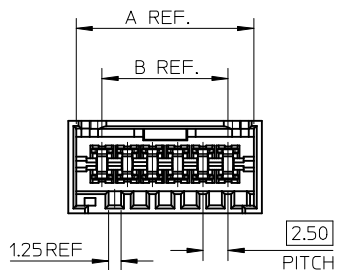

6 CIRCUIT CONNECTOR SHOWN

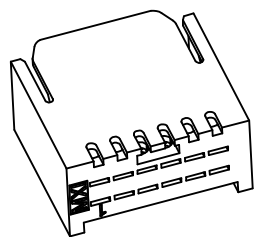
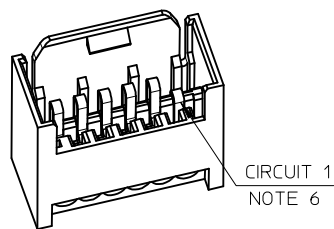

CKT	A	B
2	7.6	2.5
3	10.1	5.0
4	12.6	7.5
5	15.1	10.0
6	17.6	12.5
7	20.1	15.0
8	22.6	17.5
9	25.1	20.0
10	27.6	22.5
11	30.1	25.0
12	32.6	27.5
13	35.1	30.0
14	37.6	32.5
15	40.1	35.0
16	42.6	37.5
17	45.1	40.0
18	47.6	42.5
19	50.1	45

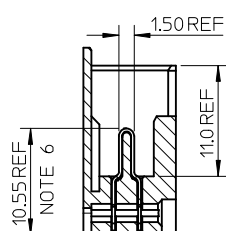
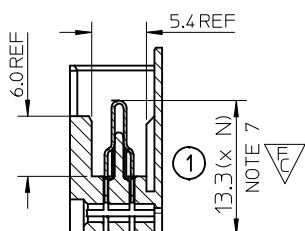
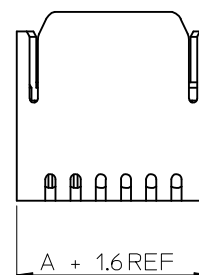
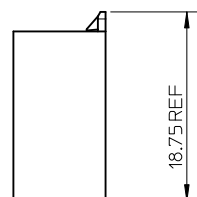
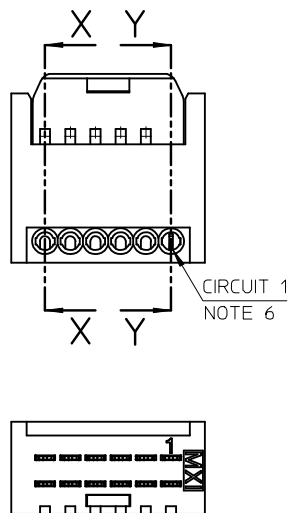
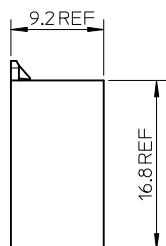

SECTION X-X

NOTES:

- MATERIALS
HOUSING: POLYAMIDE 66 (PA66)
UL94-V0. COLOUR NATURAL.
TERMINAL: COPPER ALLOY.
PLATING: PRE PLATED HOT TIN DIP 4 - 7µm
- PRODUCT CONFORMS TO SPECIFICATION PS-99020-0090.
- MATES WITH RAST 2.5 APPLIMATE FEMALE CONNS.
- SEE PACKAGING SPECIFICATION PK-93422-001.
- CONNECTOR DESIGNED FOR USE WITH PANEL 0.80MM TO 0.90MM THICKNESS.
- TERMINATED HEIGHT. CIRCUIT 1 SHOWN IN TERMINATED POSITION ONLY FOR PURPOSE OF DIMENSIONING TERMINATED HEIGHT POSITION.
- TERMINAL PRE-TERMINATED HEIGHT. N=NUMBER OF CIRCUITS.
- SEE APPLICATION SPEC AS-99033-010.
- CONNECTOR DESIGNED TO RAST 2.5 STANDARD.

LAST INSPECTION NUMBER: 1

Original Release EC NO: IPG2015-0156 DRW: MSHANAHAN 2014/08/25 CHKD: CMONAHAN 2014/10/14 APPR: MSHANAHAN 2014/11/06	QUALITY SYMBOLS 	GENERAL TOLERANCES (UNLESS SPECIFIED)		DIMENSION STYLE MM ONLY		SCALE 2:1	DESIGN UNITS METRIC	THIRD ANGLE PROJECTION		
				DRAWN BY MSHANAHAN	DATE 2013/01/30	TITLE VO FLYING HEADER ASSY 0.22 TO 0.38 WIRE 2.5MM PITCH				
				CHECKED BY CMONAHAN	DATE 2014/10/14	APPROVED BY MSHANAHAN 2014/11/06				
				MATERIAL NO. SEE SHEETS 2+		DOCUMENT NO. SD-93724-001		SHEET NO. 1 OF 4		
DRAFT WHERE APPLICABLE MUST REMAIN WITHIN DIMENSIONS		ANGULAR ± .5 °		THIS DRAWING CONTAINS INFORMATION THAT IS PROPRIETARY TO MOLEX INCORPORATED AND SHOULD NOT BE USED WITHOUT WRITTEN PERMISSION						

2-CIRCUIT

MOLEX PART NO.	MOLEX HSG. PART NO.	BLOCKED POSITION KEYS	CONFIGURATION (SEE NOTES)
93724-0001	93729-0201	NONE	

4-CIRCUIT

MOLEX PART NO.	MOLEX HSG. PART NO.	BLOCKED POSITION KEYS	CONFIGURATION (SEE NOTES)
93724-0003	93729-0401	NONE	

3-CIRCUIT

MOLEX PART NO.	MOLEX HSG. PART NO.	BLOCKED POSITION KEYS	CONFIGURATION (SEE NOTES)
93724-0002	93729-0301	NONE	

5-CIRCUIT

MOLEX PART NO.	MOLEX HSG. PART NO.	BLOCKED POSITION KEYS	CONFIGURATION (SEE NOTES)
93724-0004	93729-0501	NONE	

NOTES:

- ⊕ DENOTES LOADED TERMINAL POSITION
+ DENOTES VOIDED TERMINAL POSITION
- MOLEX HOUSING NUMBER FOR REFERENCE ONLY

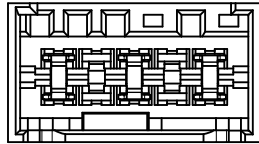

a b c d e f



1 2 3 4 5 6



CODING IDENTIFICATION
(6 CKT EXAMPLE WITH
CODING KEY G BLOCKED)
VIEW IN MATING DIRECTION

SEE SHEET 1 EC NO: IPG2015-0156 DRWN:MSHANAHAN 2014/08/25 CHKD:CMONAHAN APPR:MSHANAHAN 2014/11/06	DESCRIPTION QUALITY SYMBOLS	GENERAL TOLERANCES (UNLESS SPECIFIED)		DIMENSION STYLE MM ONLY		SCALE 3:1	DESIGN UNITS METRIC	 THIRD ANGLE PROJECTION		
			mm	INCH	DRAWN BY	DATE	TITLE			
		4 PLACES	± ---	± ---	MSHANAHAN	2013/01/30	VO FLYING HEADER ASSY 0.22 TO 0.38 WIRE 2.5MM PITCH 			
		3 PLACES	± ---	± ---	CHECKED BY	DATE				
	± 0.05	± ---	CMONAHAN	2014/10/14	DOCUMENT NO.					
	± 0.10	± ---	APPROVED BY	DATE	SHEET NO.					
	± ---	± ---	MSHANAHAN	2014/11/06	2 OF 4					
		ANGULAR ± .5 °		MATERIAL NO.		SEE CHARTS				
		DRAFT WHERE APPLICABLE MUST REMAIN WITHIN DIMENSIONS		SIZE A3		THIS DRAWING CONTAINS INFORMATION THAT IS PROPRIETARY TO MOLEX INCORPORATED AND SHOULD NOT BE USED WITHOUT WRITTEN PERMISSION				

6-CIRCUIT			
MOLEX PART NO.	MOLEX HSG. PART NO.	BLOCKED POSITION KEYS	CONFIGURATION (SEE NOTES)
93724-0005	93729-0601	NONE	

8-CIRCUIT			
MOLEX PART NO.	MOLEX HSG. PART NO.	BLOCKED POSITION KEYS	CONFIGURATION (SEE NOTES)
93724-0007	93729-0801	NONE	

7-CIRCUIT			
MOLEX PART NO.	MOLEX HSG. PART NO.	BLOCKED POSITION KEYS	CONFIGURATION (SEE NOTES)
93724-0006	93729-0701	NONE	

9-CIRCUIT			
MOLEX PART NO.	MOLEX HSG. PART NO.	BLOCKED POSITION KEYS	CONFIGURATION (SEE NOTES)
93724-0008	93729-0901	NONE	

NOTES:

- ⊕ DENOTES LOADED TERMINAL POSITION
+ DENOTES VOIDED TERMINAL POSITION
- MOLEX HOUSING NUMBER FOR REFERENCE ONLY

SEE SHEET 1 EC NO: IPG2015-0156 DRWN:MSHANAHAN 2014/08/25 CHKD:CMONAHAN 2014/10/14 APPR:MSHANAHAN 2014/11/06	DESCRIPTION	QUALITY SYMBOLS	GENERAL TOLERANCES (UNLESS SPECIFIED)	DIMENSION STYLE MM ONLY	SCALE 2:1	DESIGN UNITS METRIC	THIRD ANGLE PROJECTION
			mm INCH	DRAWN BY DATE	TITLE		
			4 PLACES ± --- ± ---	MSHANAHAN 2013/01/30	VO FLYING HEADER ASSY		
			3 PLACES ± --- ± ---	CHECKED BY DATE	0.22 TO 0.38 WIRE		
			2 PLACES ± 0.05 ± ---	CMONAHAN 2014/10/14	2.5MM PITCH		
	1 PLACE ± 0.10 ± ---	APPROVED BY DATE					
	0 PLACE ± --- ± ---	MSHANAHAN 2014/11/06					
	ANGULAR ± .5 °	MATERIAL NO.	DOCUMENT NO.		SHEET NO.		
	DRAFT WHERE APPLICABLE MUST REMAIN WITHIN DIMENSIONS	SEE CHARTS	SD-93724-001		3 OF 4		
		SIZE A3	THIS DRAWING CONTAINS INFORMATION THAT IS PROPRIETARY TO MOLEX INCORPORATED AND SHOULD NOT BE USED WITHOUT WRITTEN PERMISSION				

10-CIRCUIT			
MOLEX PART NO.	MOLEX HSG. PART NO.	BLOCKED POSITION KEYS	CONFIGURATION (SEE NOTES)
93724-0009	93729-1001	NONE	

11-CIRCUIT			
MOLEX PART NO.	MOLEX HSG. PART NO.	BLOCKED POSITION KEYS	CONFIGURATION (SEE NOTES)
93724-0010	93729-1101	NONE	

12-CIRCUIT			
MOLEX PART NO.	MOLEX HSG. PART NO.	BLOCKED POSITION KEYS	CONFIGURATION (SEE NOTES)
93724-0011	93729-1201	NONE	

13-CIRCUIT			
MOLEX PART NO.	MOLEX HSG. PART NO.	BLOCKED POSITION KEYS	CONFIGURATION (SEE NOTES)
93724-0012	93729-1301	NONE	

14-CIRCUIT			
MOLEX PART NO.	MOLEX HSG. PART NO.	BLOCKED POSITION KEYS	CONFIGURATION (SEE NOTES)
93724-0013	93729-1401	NONE	

15-CIRCUIT			
MOLEX PART NO.	MOLEX HSG. PART NO.	BLOCKED POSITION KEYS	CONFIGURATION (SEE NOTES)
93724-0014	93729-1501	NONE	

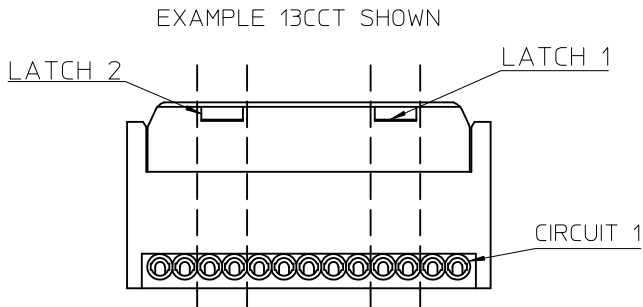

EXAMPLE 13CCT SHOWN
FOR CIRCUIT SIZE 10 AND ABOVE
2 LATCHES ARE PRESENT.
SEE TABLE BELOW FOR
POSITION OF LATCHES

LATCH 1 POSITION	LATCH 2 POSITION	CIRCUIT SIZE
ACROSS CIRCUITS	ACROSS CIRCUITS	
4 & 5	11 & 12	15
4 & 5	10 & 11	14
3 & 4	10 & 11	13
3 & 4	9 & 10	12
3 & 4	8 & 9	11
3 & 4	7 & 8	10

- NOTES:
- ⊕ DENOTES LOADED TERMINAL POSITION
+ DENOTES VOIDED TERMINAL POSITION
 - MOLEX HOUSING NUMBER FOR REFERENCE ONLY

SEE SHEET 1 EC NO: IPG2015-0156 DRAWN: MSHANAHAN 2014/08/25 CHKD: CMONAHAN 2014/10/14 APPR: MSHANAHAN 2014/11/06	QUALITY SYMBOLS DESCRIPTION	GENERAL TOLERANCES (UNLESS SPECIFIED)		DIMENSION STYLE MM ONLY		SCALE 2:1	DESIGN UNITS METRIC	THIRD ANGLE PROJECTION	
				mm	INCH	DRAWN BY MSHANAHAN		DATE 2013/01/30	
		4 PLACES		±---	±---	CHECKED BY CMONAHAN		DATE 2014/10/14	
		3 PLACES		±---	±---	APPROVED BY MSHANAHAN		DATE 2014/11/06	
		2 PLACES		±0.05	±---	MATERIAL NO.		DOCUMENT NO.	
		1 PLACE		±0.10	±---	SEE CHARTS		SD-93724-001	
0 PLACE		±---	±---	DRAFT WHERE APPLICABLE MUST REMAIN WITHIN DIMENSIONS		THIS DRAWING CONTAINS INFORMATION THAT IS PROPRIETARY TO MOLEX INCORPORATED AND SHOULD NOT BE USED WITHOUT WRITTEN PERMISSION			
ANGULAR ± .5°				SIZE A3		SHEET NO. 4 OF 4			

V0 FLYING HEADER ASSY
0.22 TO 0.38 WIRE
2.5MM PITCH

molex