

LINQ™ LED Wall Pack



Beyond LED's LINQ Series Mini Wall Pack is a traditional style wall pack that is energy-efficient and reliable, due to its compact housing and long lifespan. LINQ luminaires offers classical elegance with an aluminium housing and an excellent optic design for uniform light distribution. The LINQ luminaires are ideal for outdoor applications such as personnel doors, loading areas, hotel lobbies, driveways, and parking areas.

SKU #	Model #	Watts	Lumens	CCT	IP	Housing	Input Voltage	Certifications
153582	SKU153582 BLT-MWP03C-20D4B YFSA1-BRP50	20W	2880Lm	5000K	IP65	Bronze	100-277V	UL & DLC

Product Features

- Operating temperature: -40°C to 50°C
- Durable die-cast aluminium housing with bronze powder coat finish
- Built-in photocell
- Enclosure provides a water-tight seal making it suitable for outdoor application
- Integral LED driver, eliminates the need for an external driver or ballast
- Up to 144 lumens per watt
- Complies with UL safety regulations, cUL and is DLC5.1 listed
- High Quality and Efficacy Lumiled 2835 chips
- This product is IP65 rated, therefore, it is waterproof, sealed and gasketed wire
- Universal operation at 100-277Vac 50-60Hz
- Environment friendly with no mercury
- Easy to install and operate, with instant and no humming
- Energy saving, long lifespan with 63,000 hour life rating

Specifications



General Performance Electrical	Input Power	20W
	Lumen	Up to 2880LM
	Lumen Efficacy	Up to 144LM/W
	Color Temperature	5000K
	CRI	>80
	Beam Angle (50%) (Tolerance : ±15%)	100 Degree
	Input Voltage	100-277VAC 50/60Hz
	PF	≥0.9
	THD	≤20%
	Driver Model	HB-LPG020G-52
Physical	Driver Surge protection	L-N:2.5KV,L/N-GND:2.5KV
	Dimming	0-10V dimming standard
	Operating Temperature	-40°C TO 45°C
	Storage Temperature	-40°C TO 80°C
Qualification	Operating Humidity	10% - 90% RH
	Storage Humidity	10% - 95% RH
	LED Brand	LUMILEDS
	LED Type	SMD 2835
	LED QTY	45 PCS
	Housing	Die-cast aluminum
	Housing Color	Bronze



Correlated Color Temperature (CCT)

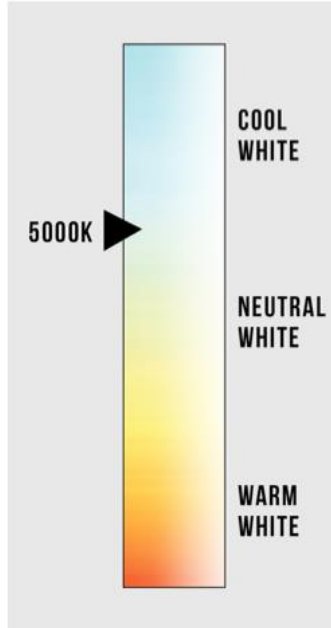

Dimensions

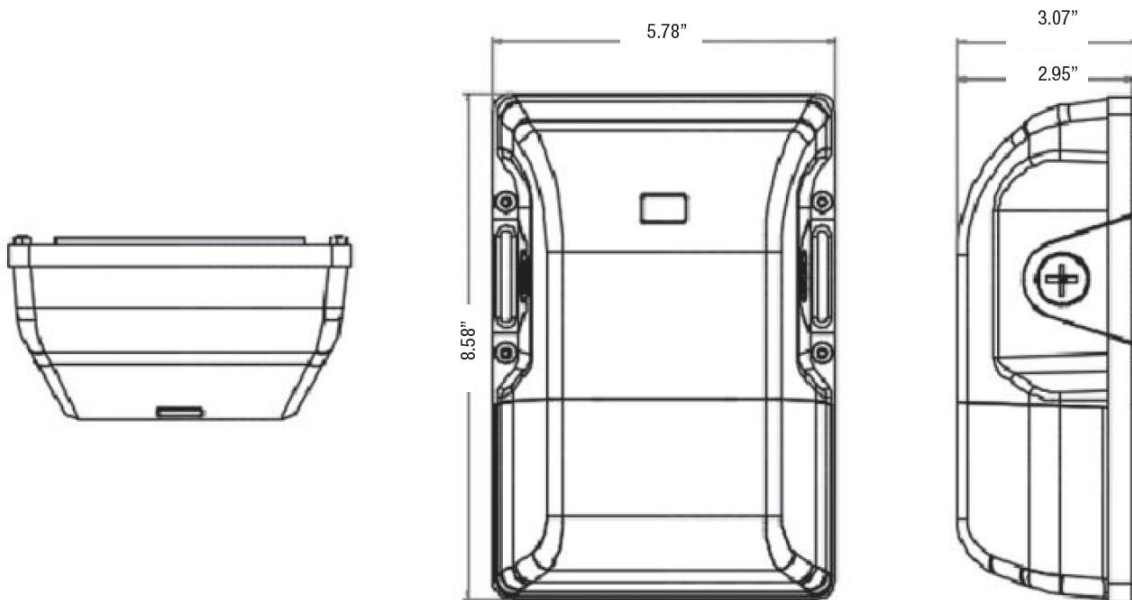

Light Distribution Testing Parameters

Luminaire Data

Voltage: 120.0 V
 Current: 0.163 A
 Power: 19.45 W
 Power Factor: 0.994

Photometric Results

Photometric Results

IES Classification: Type III
 Total Rated Lamp Lumens: 2614.2 lm
 Efficiency: 100%
 Upward Ratio: 9%
 C0r0 Intensity: 945.97 cd
 Pos of Max. Intensity: H67.5 V8

Longitudinal Classification: Very Short
 Measurement Flux: 2614.2 lm
 Downward Ratio: 91%
 Luminaire Efficacy Rating (LER): 134.46
 Max. Intensity: 1049.92 cd

Luminous Intensity Distribution Curve

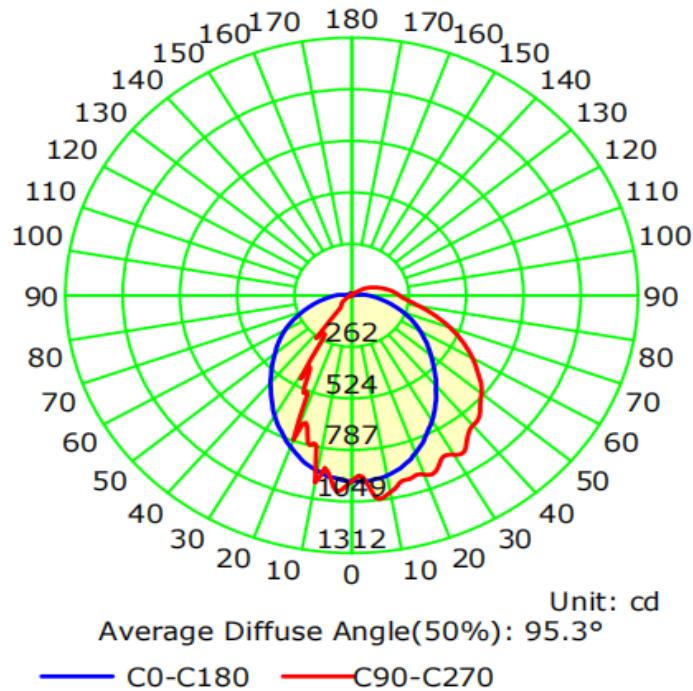

Illuminance at a Distance

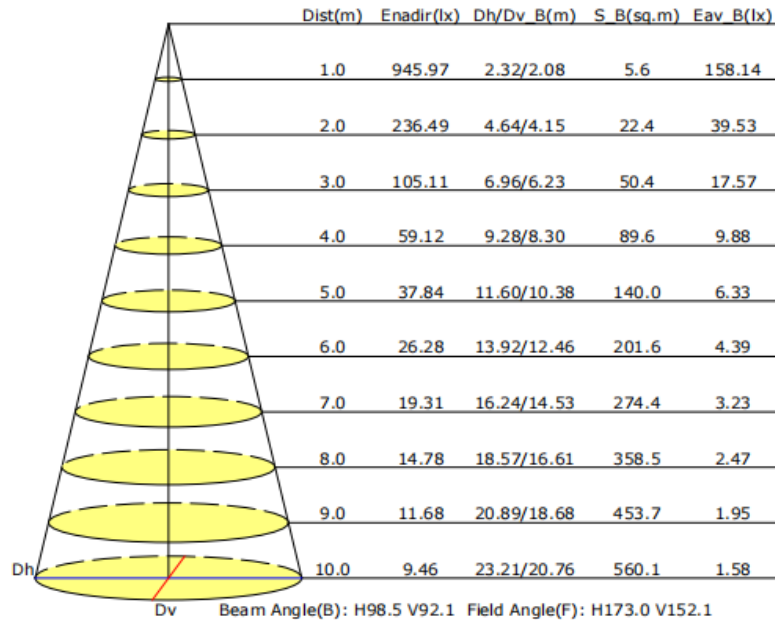

Installation Instructions

Caution

1. Can not use the electric generator to test the LED lamp.
2. Please abide by related country, regional and local law and regulations when install this fixture.
3. Please don't install the fixture when raining to lower the risk of electric shock and avoid the failure.

Notes for Users

1. To avoid possibility of electrical shock or fire, the installation personnel must have professional electric knowledge.
 2. Please wear gloves to avoid injury before installation.
 3. If any smoke or spark of the wire happened, please turn off the power immediately and notify relevant personnel.
- Please turn off power before install or change assembly parts.
 - The input voltage and lamps should be matched, after connecting the power line, Please make sure the wiring section is insulated.
 - No-professionals, must not install and disassemble the lamps.

Installation Method – 1

1. Turn off the power

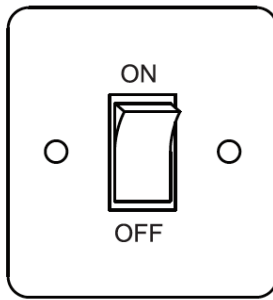

2. Loosen the 4 screws

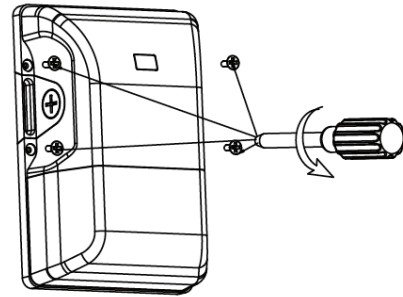

3. Remove the 1/2 end cap

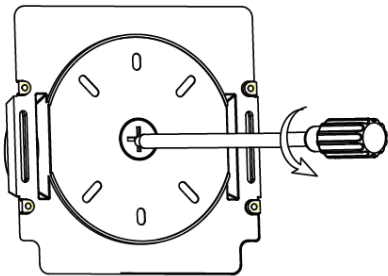

4. Peel off the yellow sticker and paste it on the round area of the bottom plate

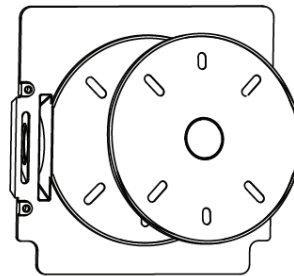

5. Fix the bottom plate on the round plate

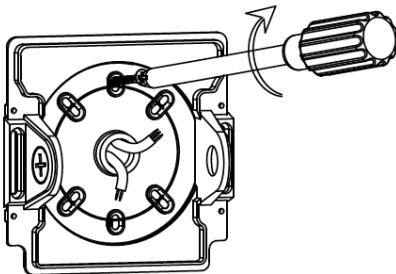

6. Make wiring connection and make sure the good protection

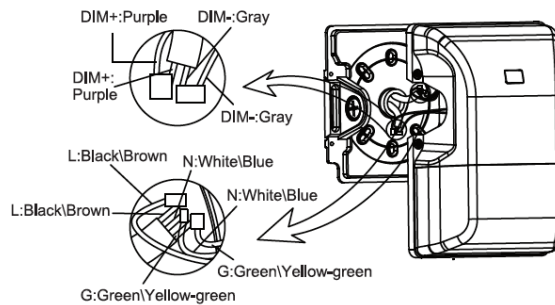

7. Fix the fixture by 4 screws

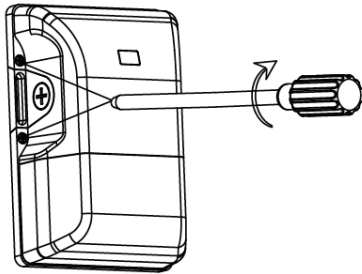

8. Make sure good wiring and screws fastening, then turn on the power

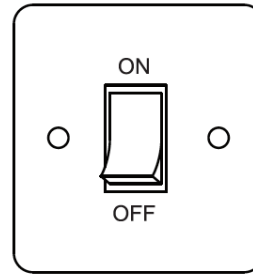

Installation Method – 2

1. Turn off the power

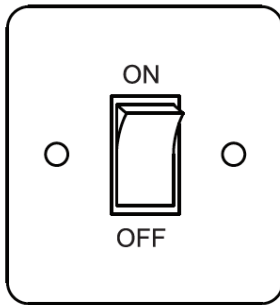

2. Loosen the 4 screws

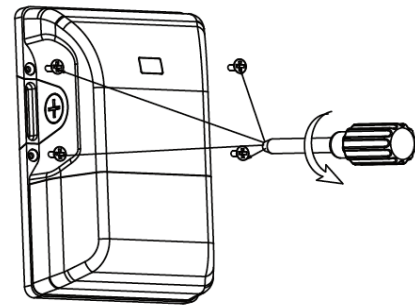

3. Paste the black sponge pad on the bottom plate

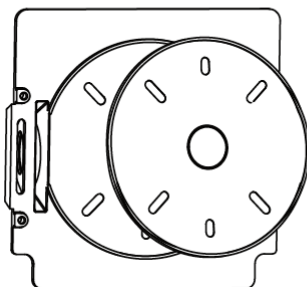

4. Screw the bottom plate on the wall

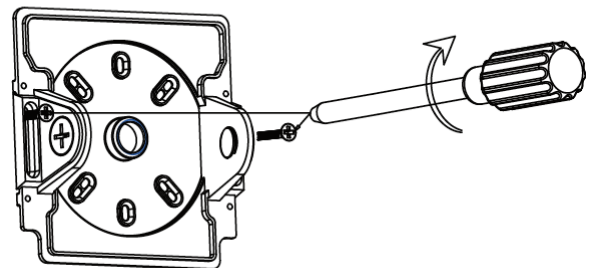

5. Remove one of the 1/2 end cap and get through wire

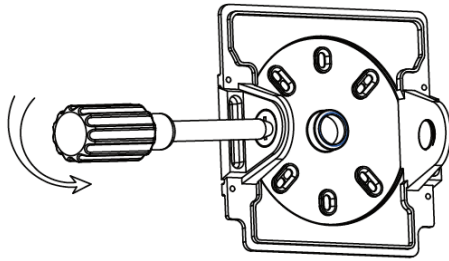

6. Make wiring connection and make sure the good protection

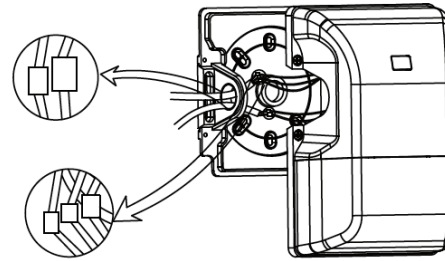

7. Return on the fixture to the bottom plate and tighten it with screws

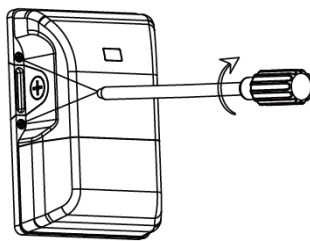

8. Turn on the power after make sure good wiring and insulation

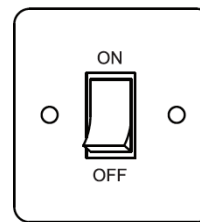

Trouble Shooting

Troubles	Check points
Flickering of the light	Turn off the power and turn on again in 3 minutes. If same phenomena occur, then call agencies.
Out of working	Please check the connection.

Packaging

Bracket Type	Carton Size	Qty / Carton	Net Weight/ Carton	Gross
Outer box	18.11 X 12.80 X 9.65 in	10 PCS	22.93 lbs	28.66 lbs
Inner box	6.06 X 3.46 X 8.86 in	1PC	2.30 lbs	2.65 lbs

Tolerance of Carton Size: ± 15 MM, Tolerance of Weight: $\pm 10\%$.

Inner Box

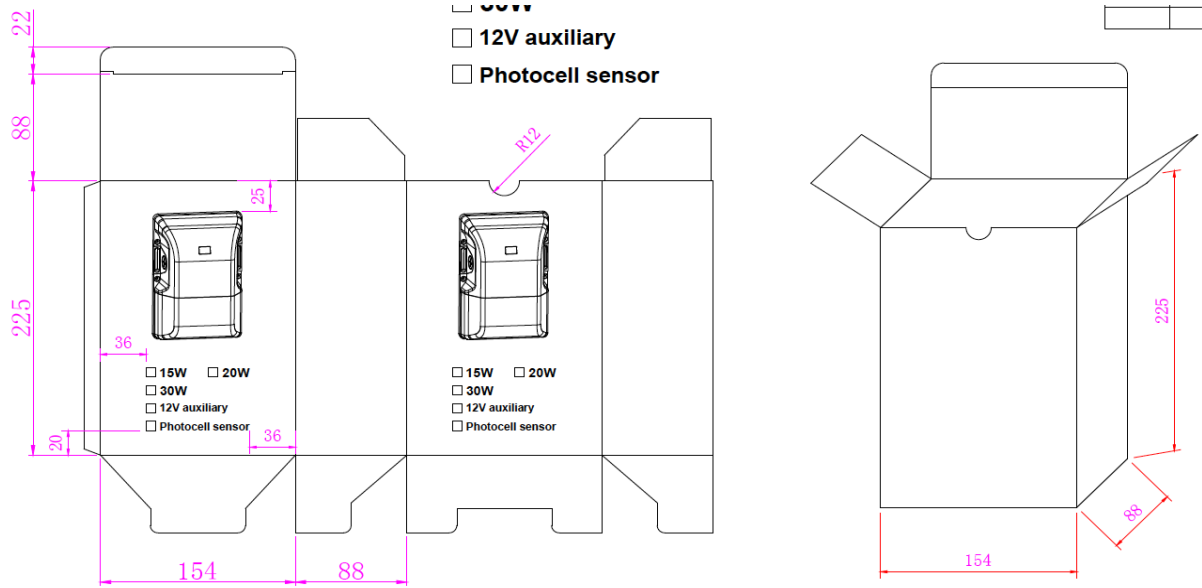

Outer Box

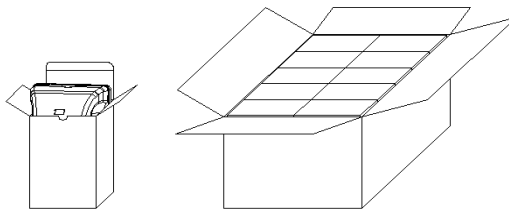
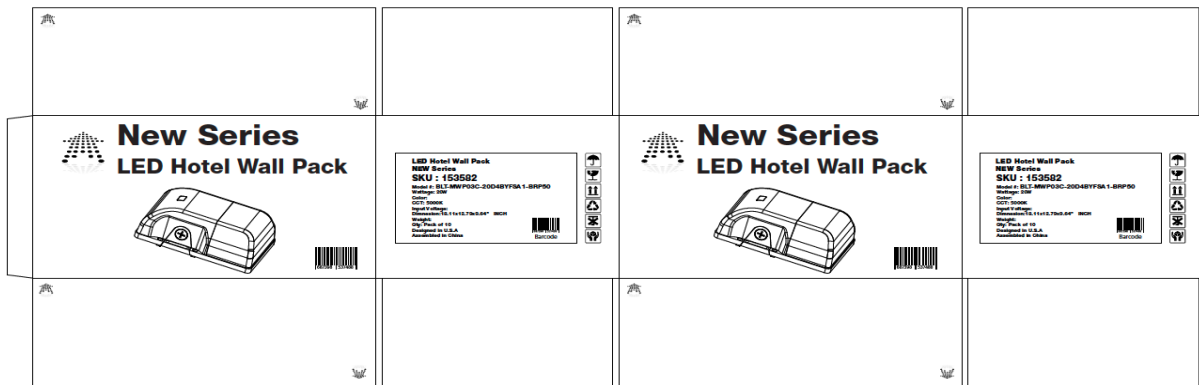

1. Please do not shake it too much during transportation, handle carefully when unloading.
2. Recommended to be stored in a warehouse of -10~ +60 °C and keep the warehouse dry.

Application

Entrance, industrial lighting, outdoor landscape and courtyard lighting, wall lighting, building, hotel, and building exterior.



Safety Precautions

To reduce the risk of death, personal injury or property damage from fire, electric shock, falling parts, cuts/abrasions, and other hazards read all warnings and instructions included with and on the fixture box and all fixture labels.

Before installing, servicing, or performing routine maintenance upon this equipment, follow these general precautions.

Commercial installation, service and maintenance of luminaires should be performed by a qualified licensed electrician.

For the installation: If you are unsure about the installation or maintenance of the luminaires, consult a qualified licensed electrician and check your local electrical code.

To prevent wiring damage or abrasion, do not expose wiring to edges of sheet metal or other sharp objects. Do not make or alter any open holes in an enclosure of wiring or electrical components during kit installation.

WARNING: RISK OF FIRE OR ELECTRICAL SHOCK

Turn off electrical power at fuse or circuit breaker box before wiring fixture to the power supply.

Turn off the power when you perform any maintenance.

Verify that supply voltage is correct by comparing it with the luminaire label information.

Make all electrical and grounded connections in accordance with the National Electrical Code and any applicable local code requirements. All wiring connections should be capped with UL approved wire connectors.

CAUTION: RISK OF INJURY

Avoid direct eye exposure to the light source while it is on.

Account for small parts and destroy packing material, as these may be hazardous to children.

Warranty

5 Years Warranty