

PLUG P/N	CKT	DIM "A"	DIM "B"
1727621002	2	5.40	4.95
1727621004	4	9.60	4.95
1727621006	6	13.80	4.95
1727621008	8	18.00	4.95
1727621010	10	22.20	12.95
1727621012	12	26.40	12.95
1727621014	14	30.60	12.95
1727621016	16	34.80	12.95
1727621018	18	39.00	20.95

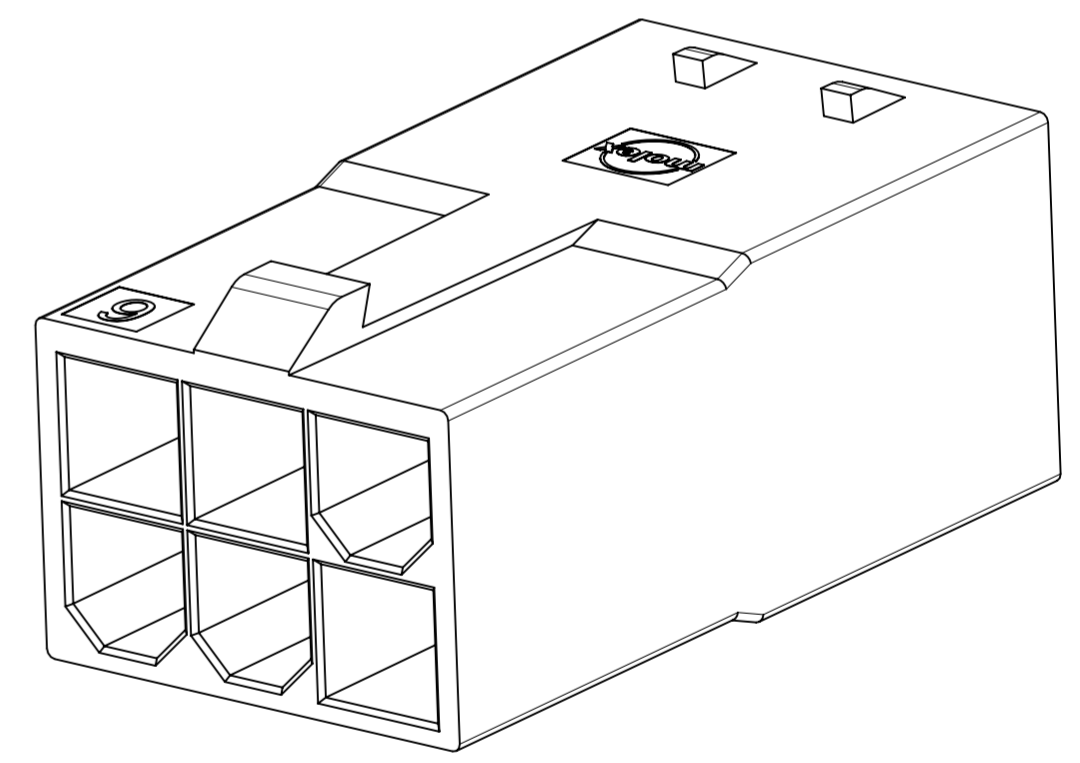
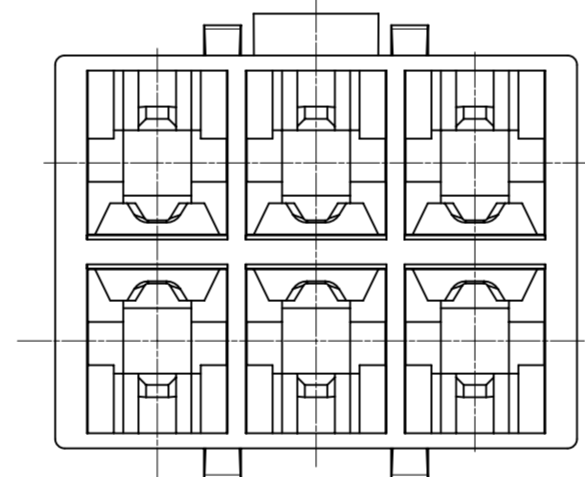
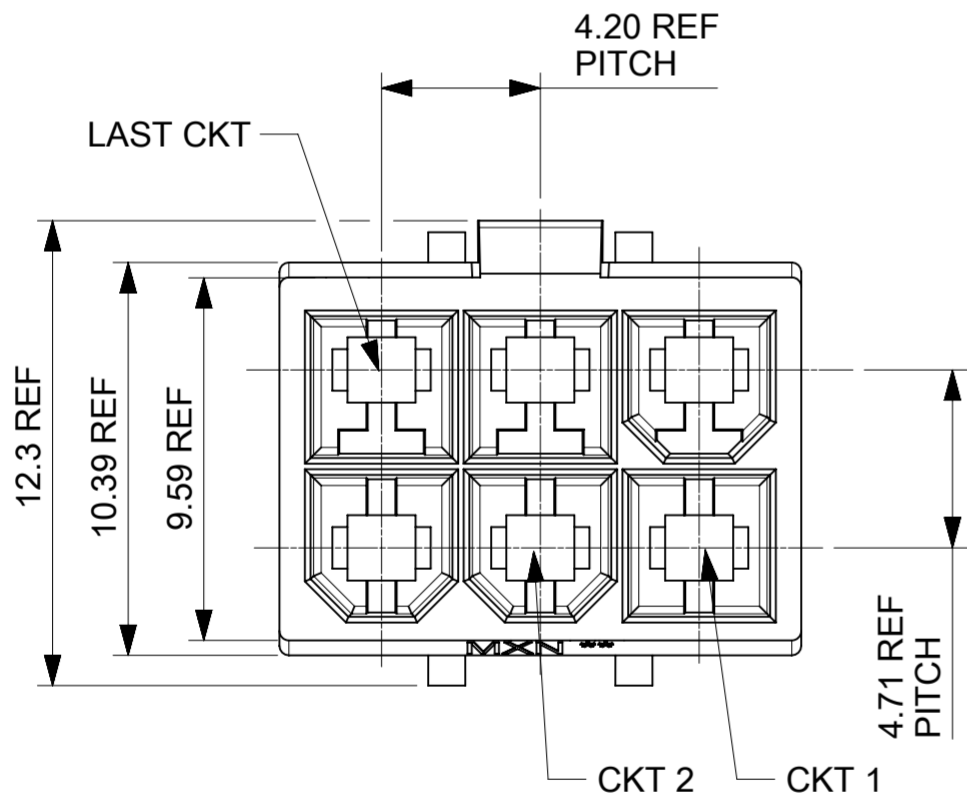

- NOTES:
1. MATERIAL: NYLON, UL 94V-0 AND GLOW WIRE CAPABLE PER IEC60335-1; COLOR: BLACK
 2. FINISH: NONE
 3. PRODUCT SPECIFICATION: 2131370000-PS/2029880002-PS
 4. APPLICATION SPECIFICATION: 2131370000-AS
 5. PACKAGING SPECIFICATION: 172762-0001-PK
 6. REFER TO AS-45499-001 FOR MOISTURIZING NYLON CONNECTOR PARTS.
 7. THIS PART TO BE USED WITH FEMALE TERMINAL SERIES 172765, 203070 AND TPA SERIES 172709-2***.
 8. THIS PART MATES WITH RECEPTACLE SERIES 172708-1***
 9. THIS PART CONFORMS TO CLASS 'B' REQUIREMENTS OF COSMETIC SPECIFICATION PS-45499-002.
 10. SEE DRAWING 1727090002-SD FOR OTHER TPA INFORMATION.
 11. SEE DRAWING 1727080002-SD FOR RECEPTACLE INFORMATION.
 12. SEE DRAWINGS SD-172718-0000 AND 2029880001-PSD FOR OTHER CRIMP TERMINAL INFORMATION.

THIS DRAWING CONTAINS INFORMATION THAT IS PROPRIETARY TO MOLEX ELECTRONIC TECHNOLOGIES, LLC AND SHOULD NOT BE USED WITHOUT WRITTEN PERMISSION									
DIMENSION UNITS	SCALE	CURRENT REV DESC:							
mm	NTS								
GENERAL TOLERANCES (UNLESS SPECIFIED)						SD-DRAWING OF MINI-FIT SIGMA DR PLUG			
ANGULAR TOL	± °								
4 PLACES	±	EC NO: 735375		2023/01/06		PRODUCT CUSTOMER DRAWING			
3 PLACES	±	DRWN: JERRYW8		2023/02/01					
2 PLACES	± 0.25	CHK'D: XQZHANG		2023/02/01		DOCUMENT NUMBER: 1727620001-SD			
1 PLACE	± 0.36	APPR: XQZHANG		2023/02/01					
0 PLACES	±	INITIAL REVISION:		2019/09/18		DOC TYPE: PSD		DOC PART: 000	
DRAFT WHERE APPLICABLE MUST REMAIN WITHIN DIMENSIONS		THIRD ANGLE PROJECTION		DRAWING: A2-SIZE		SERIES: 172762		REVISION: A5	
				MATERIAL NUMBER: SEE TABLE		CUSTOMER: GENERAL MARKET		SHEET NUMBER: 1 OF 4	

DOCUMENT STATUS	P1	RELEASE DATE	2023/02/01	07:45:18

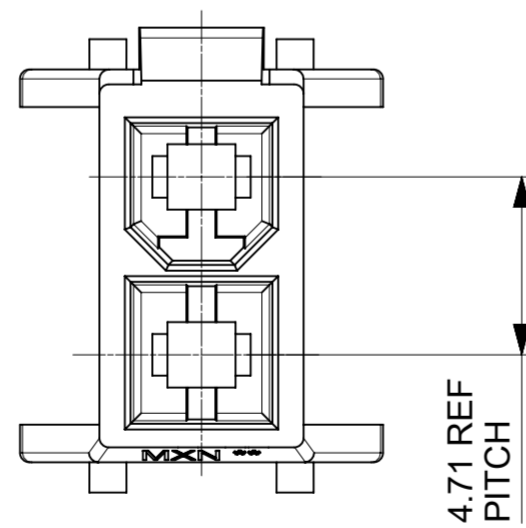
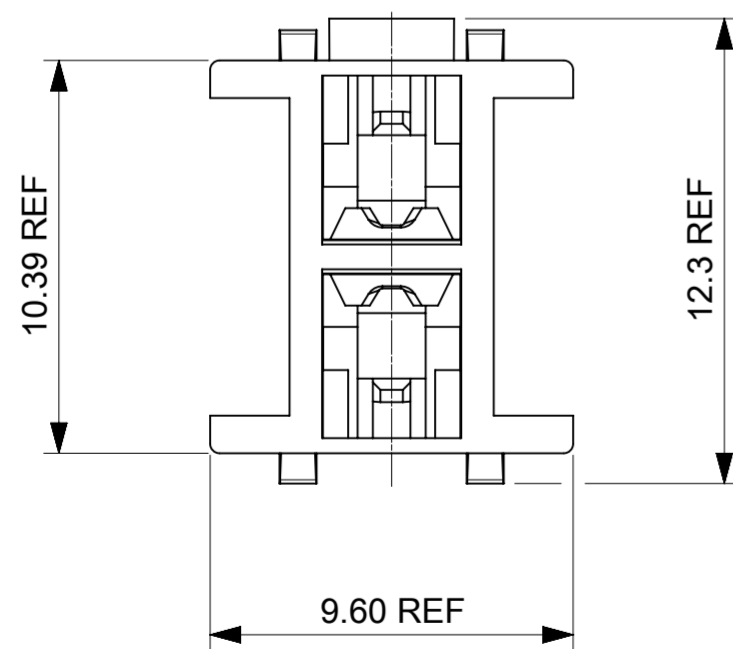
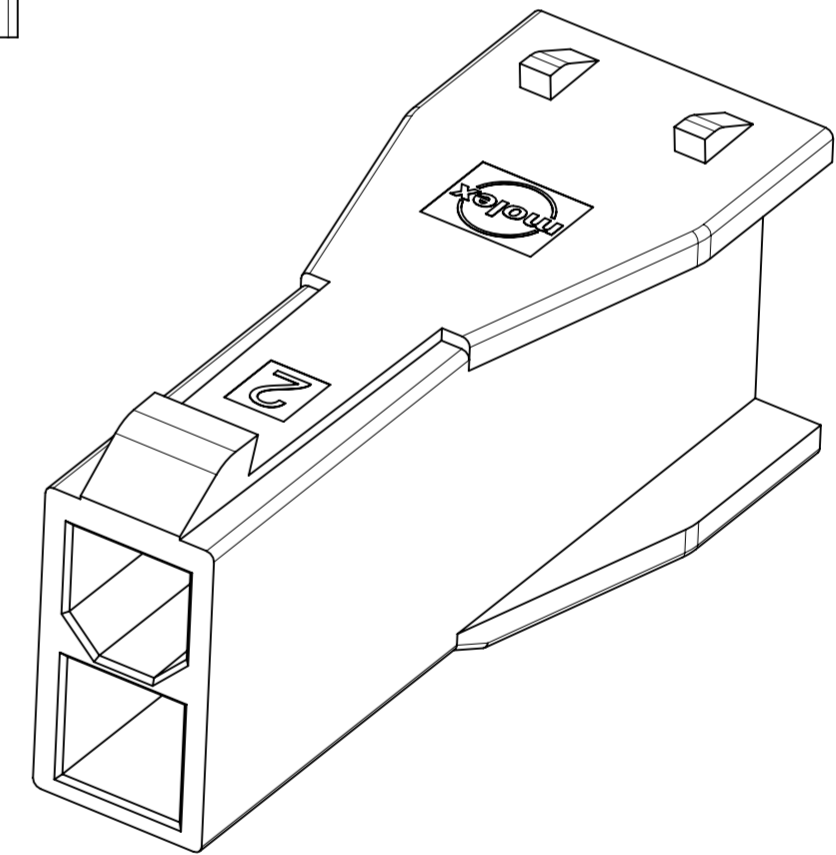
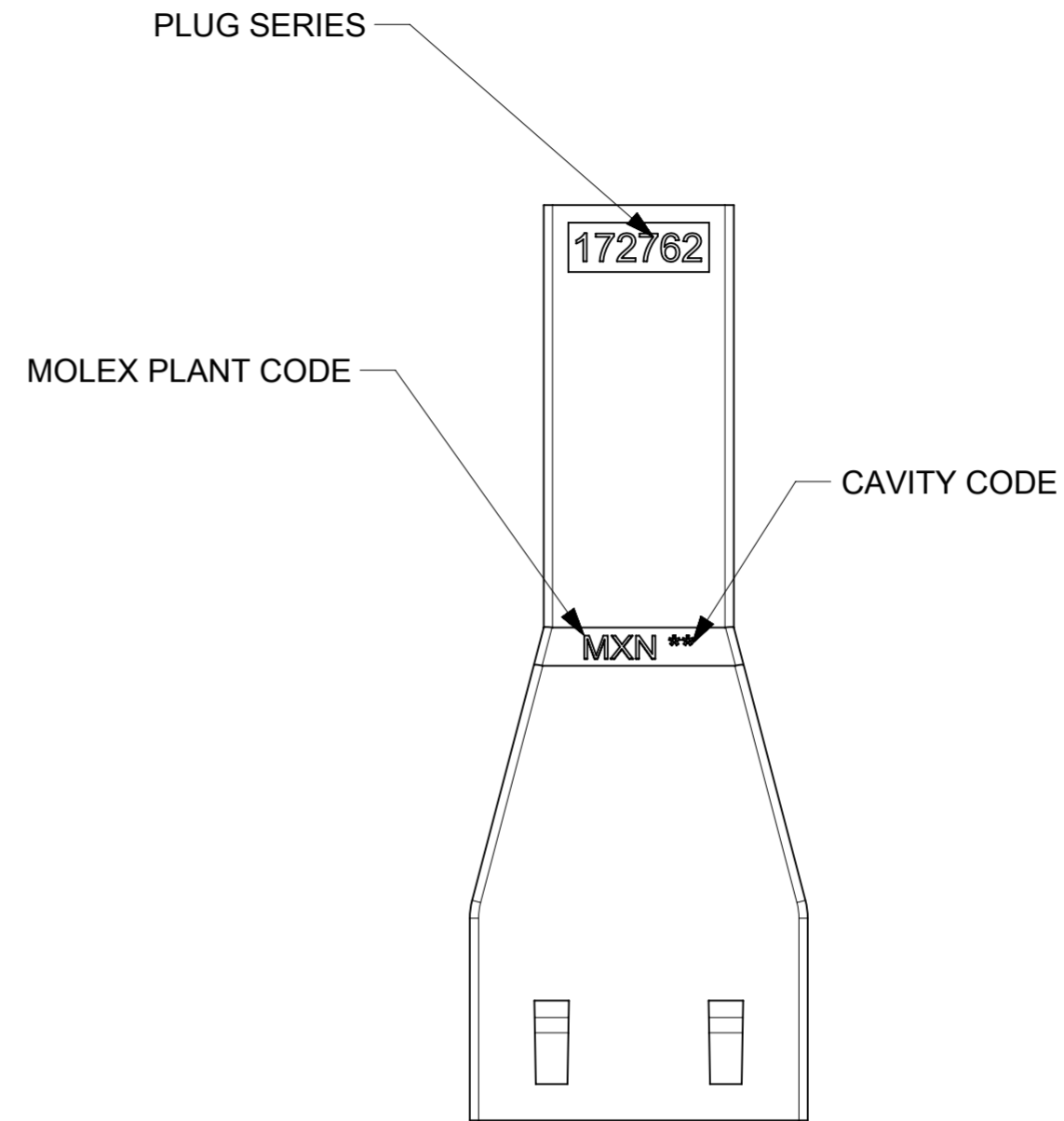
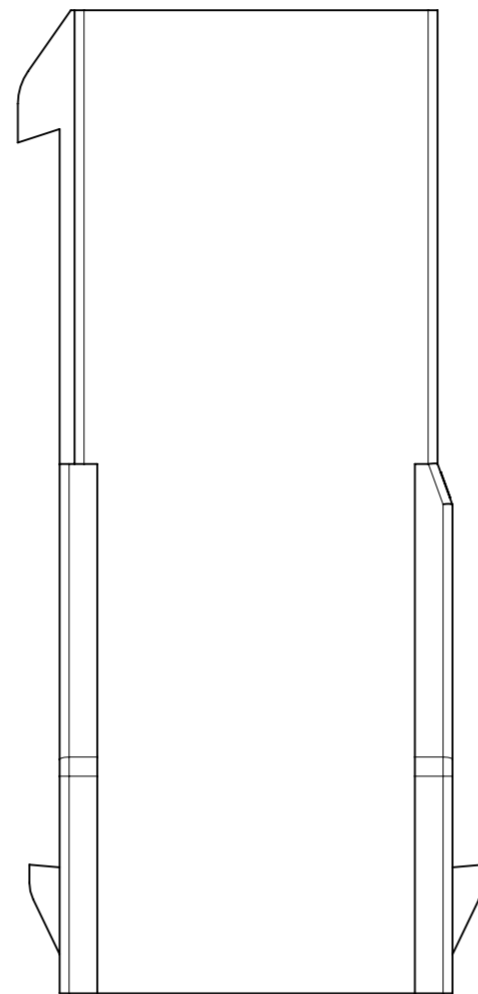
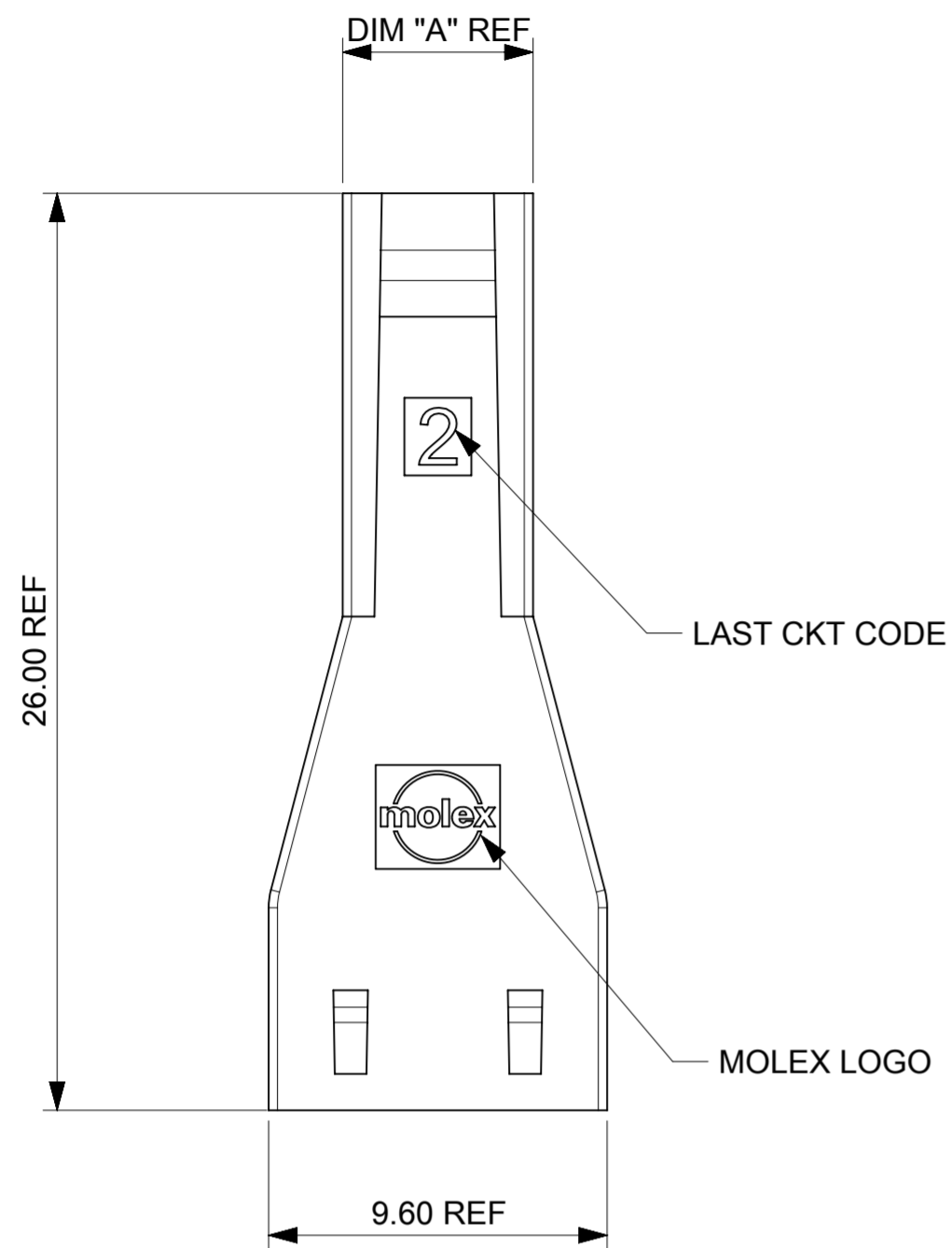

THIS DRAWING CONTAINS INFORMATION THAT IS PROPRIETARY TO MOLEX ELECTRONIC TECHNOLOGIES, LLC AND SHOULD NOT BE USED WITHOUT WRITTEN PERMISSION									
DIMENSION UNITS	SCALE	CURRENT REV DESC:				molex			
mm	NTS								
GENERAL TOLERANCES (UNLESS SPECIFIED)						SD-DRAWING OF MINI-FIT SIGMA DR PLUG			
ANGULAR TOL	± °					PRODUCT CUSTOMER DRAWING			
4 PLACES	±	EC NO: 735375							
3 PLACES	±	DRWN: JERRYW8	2023/01/06						
2 PLACES	± 0.25	CHK'D: XQZHANG	2023/02/01						
1 PLACE	± 0.36	APPR: XQZHANG	2023/02/01						
0 PLACES	±	INITIAL REVISION:							
DRAFT WHERE APPLICABLE MUST REMAIN WITHIN DIMENSIONS		DRWN: ALU002	2019/09/18				DOCUMENT NUMBER		
		APPR: YXZHENG	2019/10/11				1727620001-SD		
		THIRD ANGLE PROJECTION	DRAWING	SERIES	MATERIAL NUMBER	CUSTOMER	DOC TYPE	DOC PART	REVISION
			A2-SIZE	172762	SEE TABLE	GENERAL MARKET	PSD	000	A5
									SHEET NUMBER
									2 OF 4

DOCUMENT STATUS	P1	RELEASE DATE	2023/02/01	07:45:18
-----------------	----	--------------	------------	----------

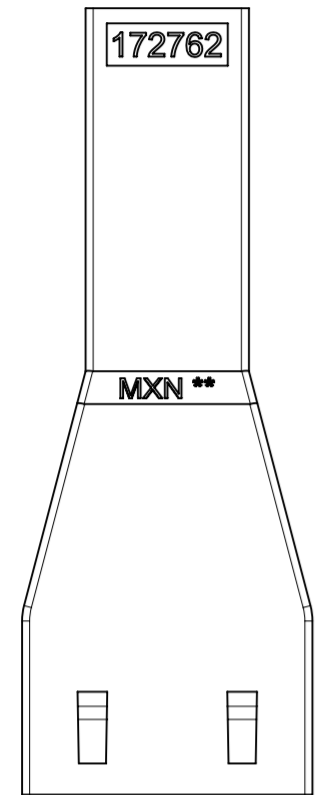
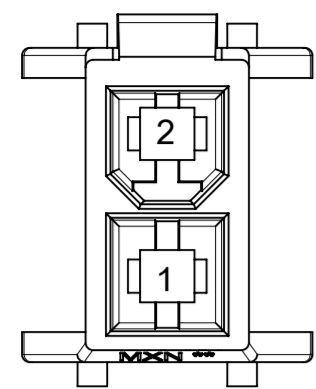

2-CKT

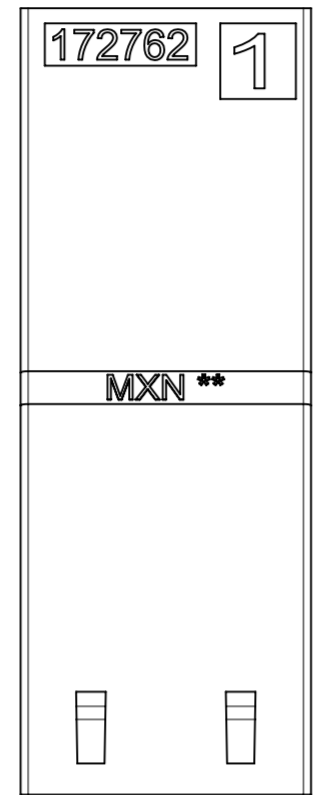
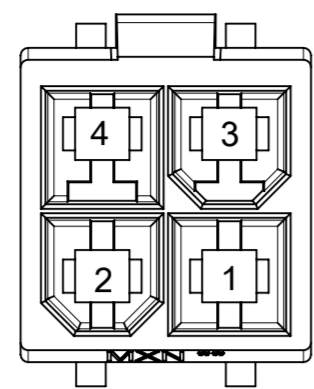

4-CKT

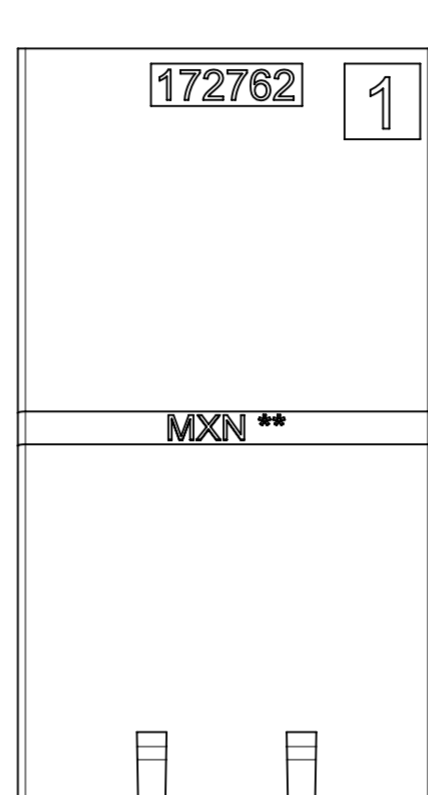
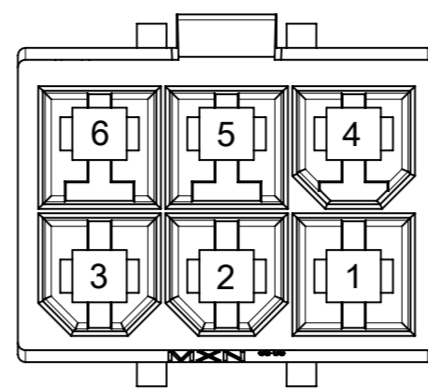

6-CKT

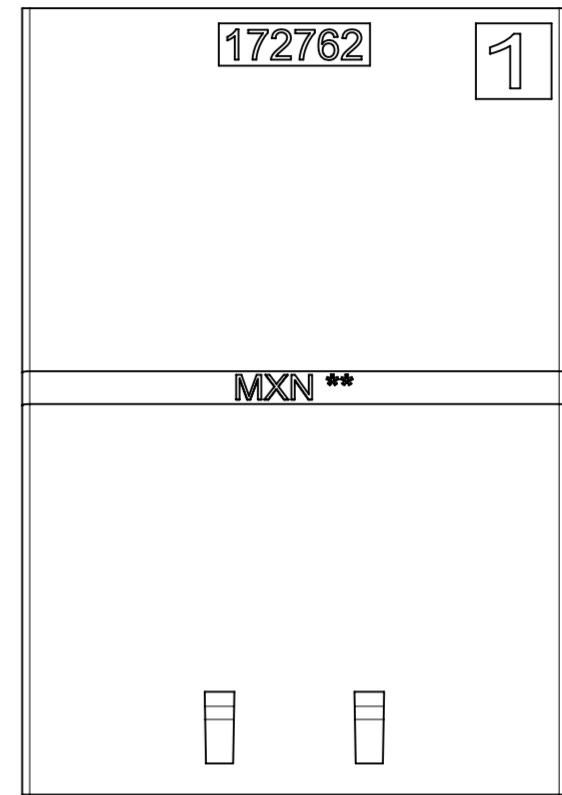
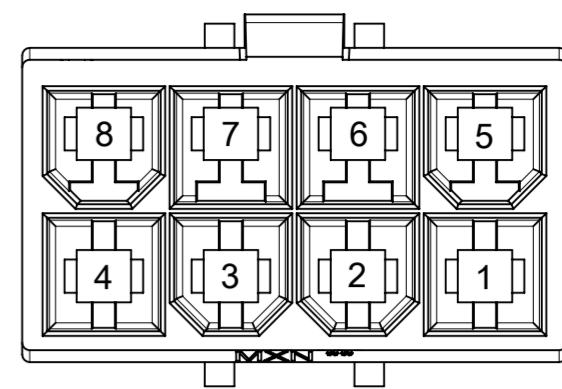

8-CKT

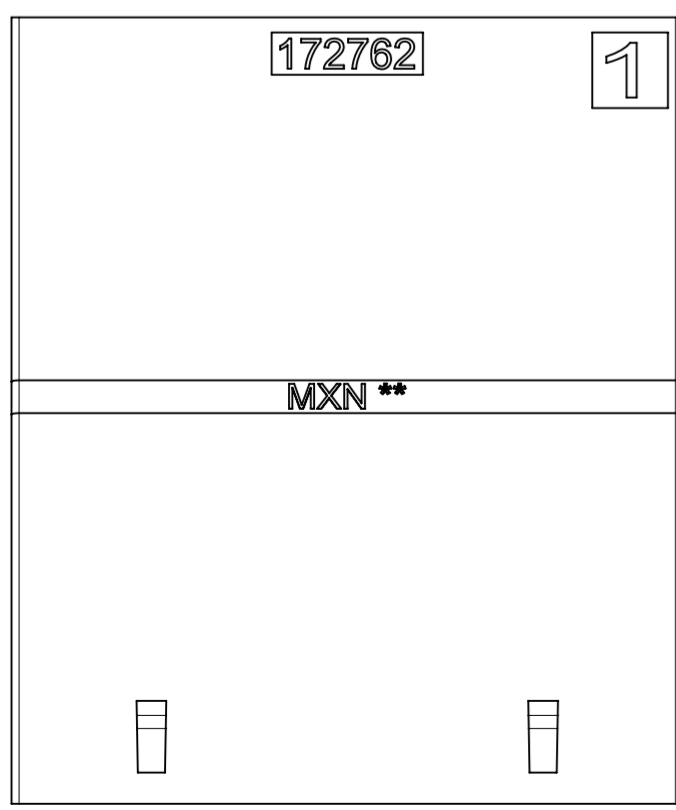
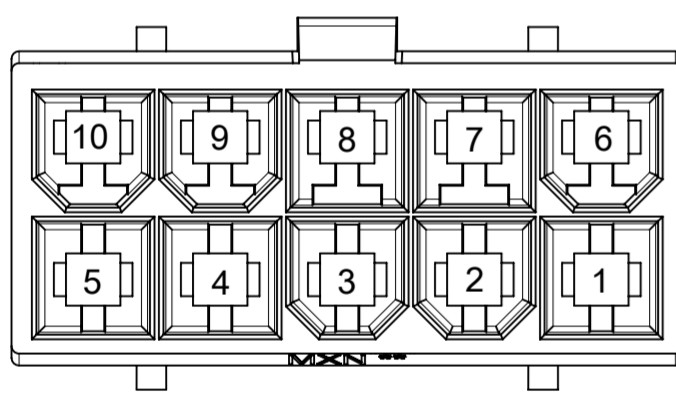

10-CKT

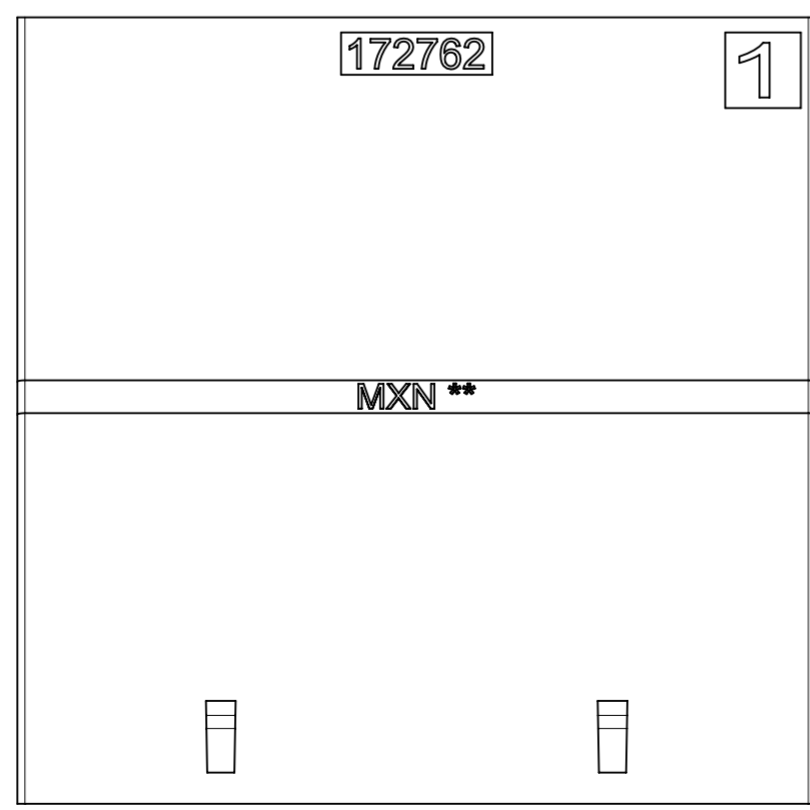
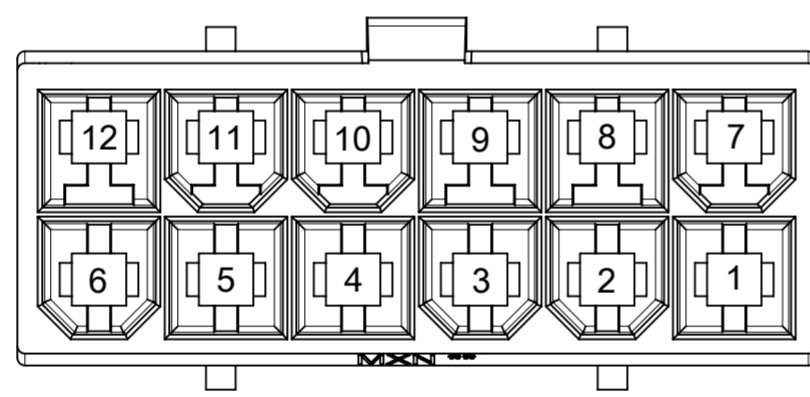

12-CKT

THIS DRAWING CONTAINS INFORMATION THAT IS PROPRIETARY TO MOLEX ELECTRONIC TECHNOLOGIES, LLC AND SHOULD NOT BE USED WITHOUT WRITTEN PERMISSION									
DIMENSION UNITS		SCALE		CURRENT REV DESC:					
mm		NTS							
GENERAL TOLERANCES (UNLESS SPECIFIED)				EC NO: 735375				SD-DRAWING OF MINI-FIT SIGMA DR PLUG	
ANGULAR TOL ± °				DRWN: JERRYW8 2023/01/06					
4 PLACES ±				CHK'D: XQZHANG 2023/02/01				PRODUCT CUSTOMER DRAWING	
3 PLACES ±				APPR: XQZHANG 2023/02/01					
2 PLACES ± 0.25				INITIAL REVISION:				DOCUMENT NUMBER	
1 PLACE ± 0.36				DRWN: ALUO02 2019/09/18					
0 PLACES ±				APPR: YXZHENG 2019/10/11				1727620001-SD	
DRAFT WHERE APPLICABLE MUST REMAIN WITHIN DIMENSIONS		THIRD ANGLE PROJECTION		DRAWING		SERIES		MATERIAL NUMBER	
				A2-SIZE		172762		SEE TABLE	
				GENERAL MARKET		CUSTOMER		SHEET NUMBER	
						3 OF 4			

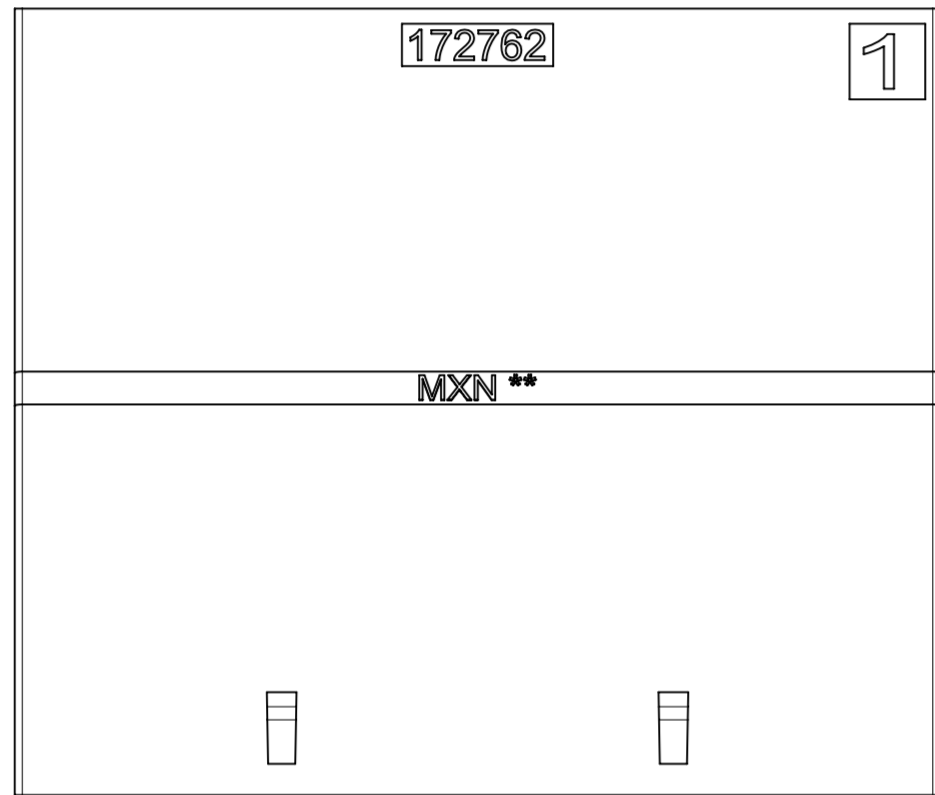
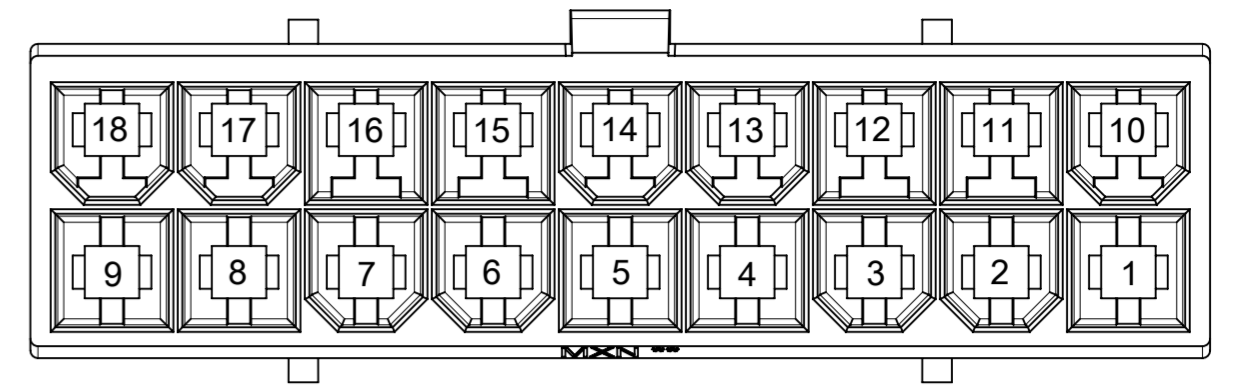
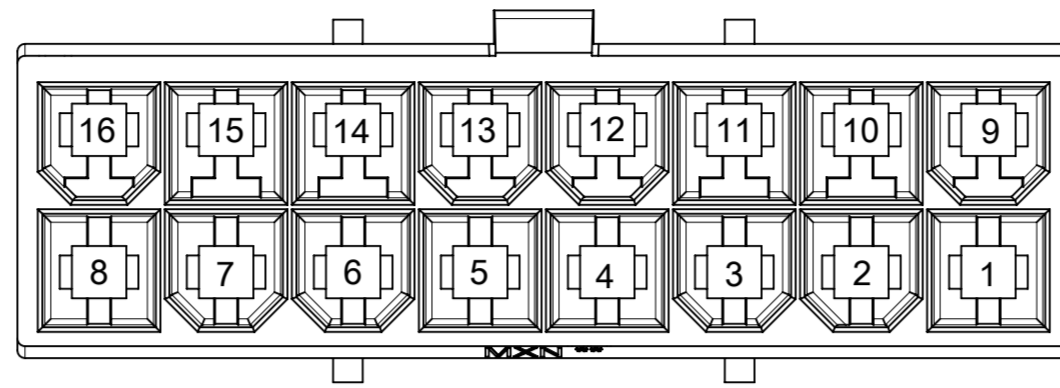
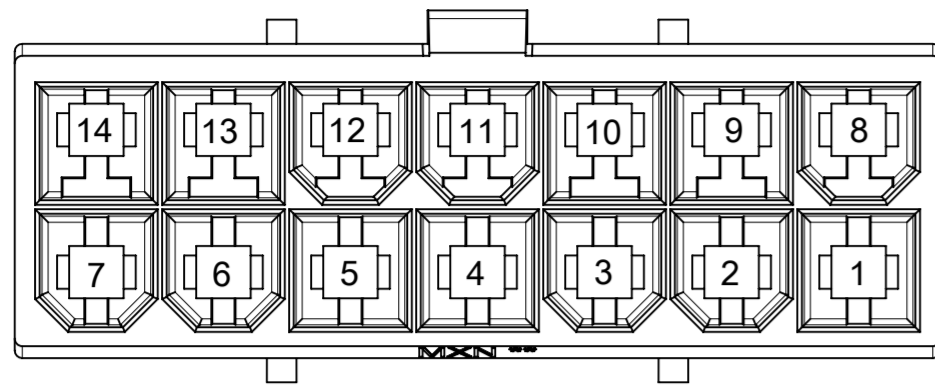

14-CKT

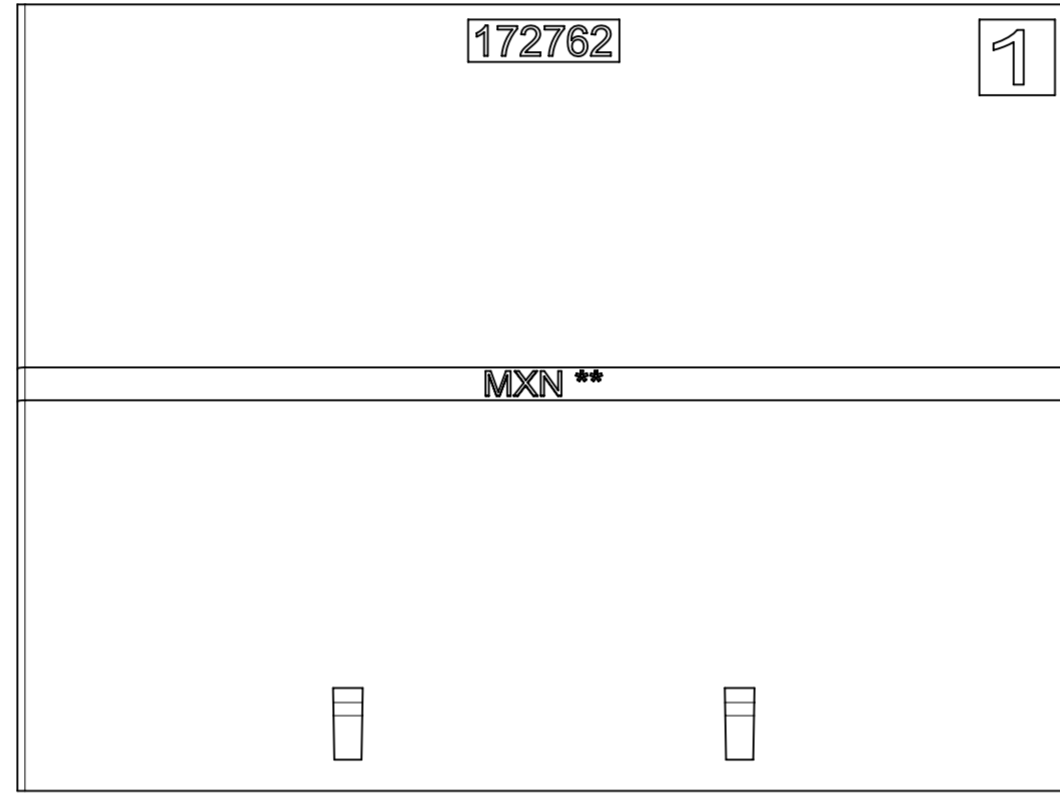

16-CKT

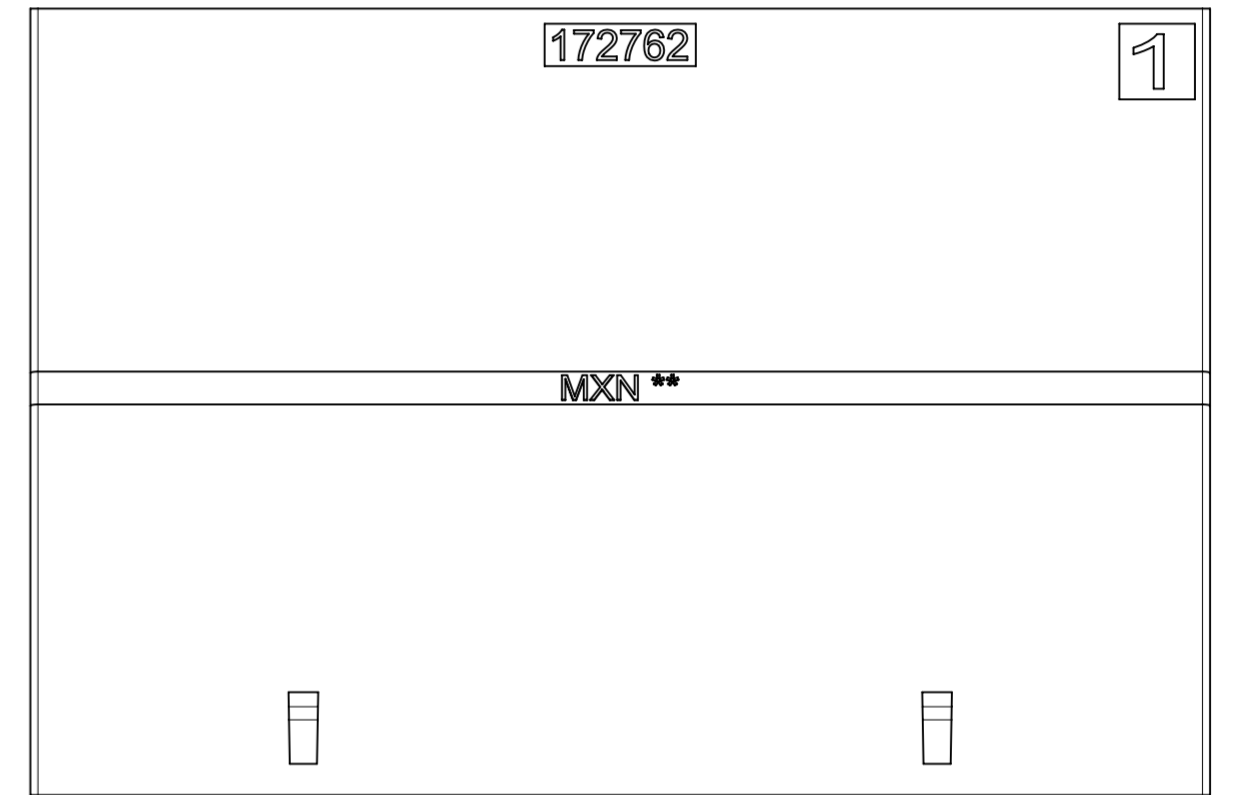

18-CKT

THIS DRAWING CONTAINS INFORMATION THAT IS PROPRIETARY TO MOLEX ELECTRONIC TECHNOLOGIES, LLC AND SHOULD NOT BE USED WITHOUT WRITTEN PERMISSION									
DIMENSION UNITS	SCALE	CURRENT REV DESC:				molex			
mm	NTS								
GENERAL TOLERANCES (UNLESS SPECIFIED)						SD-DRAWING OF MINI-FIT SIGMA DR PLUG			
ANGULAR TOL	± °					PRODUCT CUSTOMER DRAWING			
4 PLACES	±	EC NO: 735375		2023/01/06		DOCUMENT NUMBER			
3 PLACES	±	DRWN: JERRYW8		2023/02/01					
2 PLACES	± 0.25	CHK'D: XQZHANG		2023/02/01		1727620001-SD			
1 PLACE	± 0.36	APPR: XQZHANG		2023/02/01					
0 PLACES	±	INITIAL REVISION:				DOC TYPE			
DRAFT WHERE APPLICABLE MUST REMAIN WITHIN DIMENSIONS		DRWN: ALUO02		2019/09/18					
		APPR: YXZHENG		2019/10/11		DOC PART			
		THIRD ANGLE PROJECTION							
		DRAWING		SERIES		MATERIAL NUMBER			
		A2-SIZE		172762					
						SHEET NUMBER			
						4 OF 4			