

REV.	ECN NO.	DESCRIPTION	SIGN	DATE
C1	N/A	INITIAL DRAWING	Liu	2020/04/27

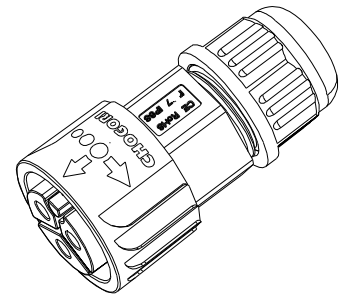

- Specification:
- 1.Operation Temperature: -45°C~105°C.
  - 2.Insulation Resistance:100MΩ at DC500V.
  - 3.Contact Resistance:<10mΩ
  - 4.Withstand Voltage: 2000V AC
  - 5.Operating Current:50A
  - 6.Operating Voltage:AC 300V
  - 7.Waterproof Rate:IP67 (Mated)
  - 8.Seal Nut:Nylon, Black
  - 9.Seal Ring:Silicon, Black.
  - 10.Clamp Ring:Nylon, Black
  - 11.O-Ring:Silicon, Red
  - 12.Female Pin:Copper Alloy, Gold Plated
  - 13.Connector:Nylon+GF, Black
  - 14.Lock Nut:Nylon,Orange
  - 15.Spring:SUS
  - 16.O-Ring:Silicon, Red
  - 14.RoHS Compliant.
  - 15.Mating Cap:804-00008-00

24XXX231-XX Cable Range OD  
 03 OD: φ5.5mm~φ6.5mm  
 04 OD: φ8.0mm~φ10.5mm  
 Pin Number

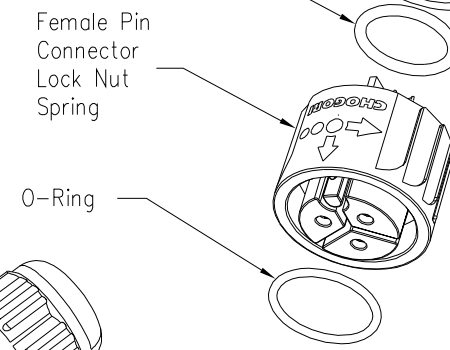
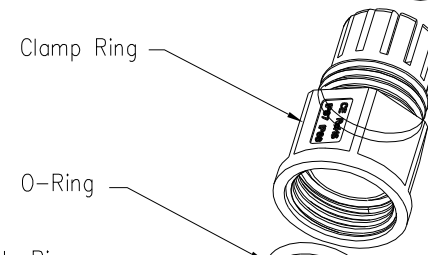
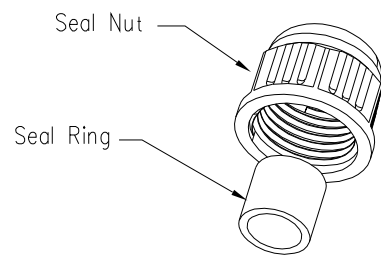
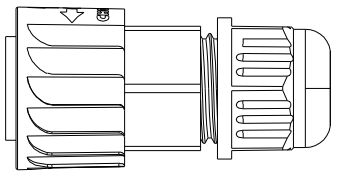
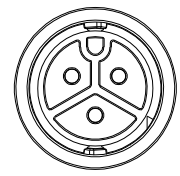
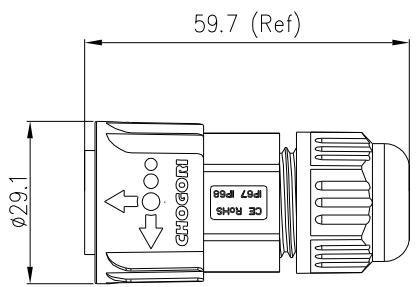
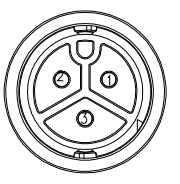

3 Pin  
 P/N: 24003231-0X  
 Pin Assignments Front View

UNIT:mm	DESCRIPTION	PART NO	DRAWN BY	DATE
TOLERANCE .X ±0.25 .XX ±0.15 .XXX ±0.05 ANGLES ±1°	Large Series Push Lock Male Plug With Female Pin	24XXX231-XX	Liu	2020/04/27
SCALE: 1:1	SHEET 1 OF 1	DWG NO	CHECKED BY	DATE
REV. C1	SIZE A4	CUSTOMER	Mo	2020/04/27
	* :Inspection Item		APPROVED BY	DATE
			Adley	2020/04/27



THIS INFORMATION IS CONFIDENTIAL AND IS DISCLOSED TO YOU ON CONDITION THAT NO FURTHER DISCLOSURE IS MADE BY YOU TO OTHER THAN CHOGORI PERSONNEL WITHOUT AUTHORIZATION FROM CHOGORI CORP.