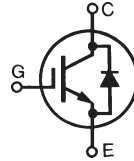

**XPT™ 650V IGBT
GenX3™ w/ Diode**
**IXYH40N65B3D1
IXYQ40N65B3D1**

 Extreme Light Punch Through
IGBT for 5-30kHz Switching

$$V_{CES} = 650V$$

$$I_{C110} = 40A$$

$$V_{CE(sat)} \leq 2.0V$$

$$t_{fi(typ)} = 73ns$$

Symbol	Test Conditions	Maximum Ratings	
V_{CES}	$T_J = 25^\circ C$ to $175^\circ C$	650	V
V_{CGR}	$T_J = 25^\circ C$ to $175^\circ C$, $R_{GE} = 1M\Omega$	650	V
V_{GES}	Continuous	± 20	V
V_{GEM}	Transient	± 30	V
I_{C25}	$T_C = 25^\circ C$	86	A
I_{C110}	$T_C = 110^\circ C$	40	A
I_{F110}	$T_C = 110^\circ C$	50	A
I_{CM}	$T_C = 25^\circ C$, 1ms	195	A
I_A	$T_C = 25^\circ C$	20	A
E_{AS}	$T_C = 25^\circ C$	300	mJ
SSOA (RBSOA)	$V_{GE} = 15V$, $T_{VJ} = 150^\circ C$, $R_G = 10\Omega$ Clamped Inductive Load	$I_{CM} = 80$ @ $V_{CE} \leq V_{CES}$	A
t_{sc} (SCSOA)	$V_{GE} = 15V$, $V_{CE} = 360V$, $T_J = 150^\circ C$ $R_G = 82\Omega$, Non Repetitive	5	μs
P_C	$T_C = 25^\circ C$	300	W
T_J		-55 ... +175	$^\circ C$
T_{JM}		175	$^\circ C$
T_{stg}		-55 ... +175	$^\circ C$
T_L	Maximum Lead Temperature for Soldering	300	$^\circ C$
T_{SOLD}	1.6 mm (0.062in.) from Case for 10s	260	$^\circ C$
M_d	Mounting Torque	1.13/10	Nm/lb.in
Weight	TO-247	6.0	g
	TO-3P	5.5	g

TO-247 (IXYH)

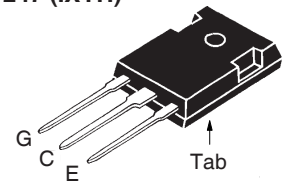

TO-3P (IXYQ)

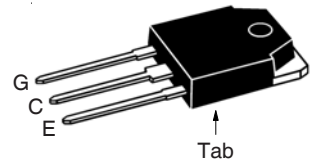

G = Gate C = Collector
E = Emitter Tab = Collector

Features

- Optimized for Low 5-30kHz Switching
- Square RBSOA
- Anti-Parallel Fast Diode
- Avalanche Rated
- Short Circuit Capability

Advantages

- High Power Density
- Extremely Rugged
- Low Gate Drive Requirement

Applications

- Power Inverters
- UPS
- Motor Drives
- SMPS
- PFC Circuits
- Battery Chargers
- Welding Machines
- Lamp Ballasts

Symbol	Test Conditions ($T_J = 25^\circ C$, Unless Otherwise Specified)	Characteristic Values		
		Min.	Typ.	Max.
BV_{CES}	$I_C = 250\mu A$, $V_{GE} = 0V$	650		V
$V_{GE(th)}$	$I_C = 250\mu A$, $V_{CE} = V_{GE}$	3.5		6.0 V
I_{CES}	$V_{CE} = V_{CES}$, $V_{GE} = 0V$ $T_J = 150^\circ C$			10 μA 1.5 mA
I_{GES}	$V_{CE} = 0V$, $V_{GE} = \pm 20V$			± 100 nA
$V_{CE(sat)}$	$I_C = 40A$, $V_{GE} = 15V$, Note 1 $T_J = 150^\circ C$		1.7 2.0	2.0 V V

Symbol Test Conditions ($T_J = 25^\circ\text{C}$ Unless Otherwise Specified)		Characteristic Values		
		Min.	Typ.	Max.
g_{fs}	$I_C = 40\text{A}, V_{CE} = 10\text{V}$, Note 1	16	27	S
C_{ies}	$V_{CE} = 25\text{V}, V_{GE} = 0\text{V}, f = 1\text{MHz}$		1880	pF
C_{oes}			210	pF
C_{res}			43	pF
$Q_{g(on)}$	$I_C = 40\text{A}, V_{GE} = 15\text{V}, V_{CE} = 0.5 \cdot V_{CES}$		68	nC
Q_{ge}			10	nC
Q_{gc}			33	nC
$t_{d(on)}$	Inductive load, $T_J = 25^\circ\text{C}$ $I_C = 30\text{A}, V_{GE} = 15\text{V}$ $V_{CE} = 400\text{V}, R_G = 10\Omega$ Note 2		20	ns
t_{ri}			37	ns
E_{on}			0.80	mJ
$t_{d(off)}$			140	ns
t_{fi}			73	ns
E_{off}			0.70	1.25
$t_{d(on)}$	Inductive load, $T_J = 150^\circ\text{C}$ $I_C = 30\text{A}, V_{GE} = 15\text{V}$ $V_{CE} = 400\text{V}, R_G = 10\Omega$ Note 2		20	ns
t_{ri}			37	ns
E_{on}			1.60	mJ
$t_{d(off)}$			176	ns
t_{fi}			174	ns
E_{off}			1.15	mJ
R_{thJC}			0.50	$^\circ\text{C/W}$
R_{thCS}		0.25		$^\circ\text{C/W}$

Reverse Diode (FRED)

Symbol Test Conditions ($T_J = 25^\circ\text{C}$ Unless Otherwise Specified)		Characteristic Values		
		Min.	Typ.	Max.
V_F	$I_F = 30\text{A}, V_{GE} = 0\text{V}$, Note 1			2.5
		$T_J = 150^\circ\text{C}$	1.2	V
I_{rr}	$I_F = 30\text{A}, V_{GE} = 0\text{V},$ $-di_F/dt = 500\text{A}/\mu\text{s}, V_R = 400\text{V}$	$T_J = 150^\circ\text{C}$	24	A
t_{rr}		$T_J = 150^\circ\text{C}$	125	ns
R_{thJC}				0.60 $^\circ\text{C/W}$

Notes:

1. Pulse test, $t \leq 300\mu\text{s}$, duty cycle, $d \leq 2\%$.
2. Switching times & energy losses may increase for higher $V_{CE}(\text{clamp})$, T_J or R_G .

ADVANCE TECHNICAL INFORMATION

The product presented herein is under development. The Technical Specifications offered are derived from a subjective evaluation of the design, based upon prior knowledge and experience, and constitute a "considered reflection" of the anticipated result. IXYS reserves the right to change limits, test conditions, and dimensions without notice.

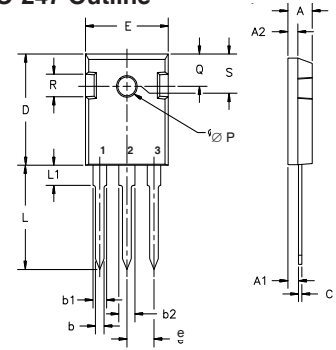
TO-247 Outline

 Terminals: 1 - Gate 2 - Collector
 3 - Emitted

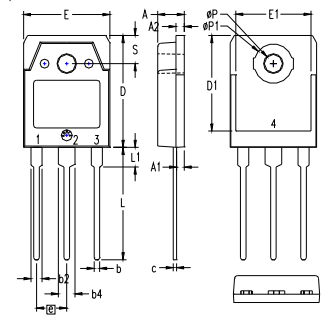
Dim.	Millimeter		Inches	
	Min.	Max.	Min.	Max.
A	4.7	5.3	.185	.209
A ₁	2.2	2.54	.087	.102
A ₂	2.2	2.6	.059	.098
b	1.0	1.4	.040	.055
b ₁	1.65	2.13	.065	.084
b ₂	2.87	3.12	.113	.123
C	.4	.8	.016	.031
D	20.80	21.46	.819	.845
E	15.75	16.26	.610	.640
e	5.20	5.72	0.205	0.225
L	19.81	20.32	.780	.800
L1		4.50		.177
∅P	3.55	3.65	.140	.144
Q	5.89	6.40	0.232	0.252
R	4.32	5.49	.170	.216
S	6.15	BSC	242	BSC

TO-3P Outline

 1 = Gate 2,4 = Collector
 3 = Emitter

SYM	INCHES		MILLIMETERS	
	MIN	MAX	MIN	MAX
A	.185	.193	4.70	4.90
A1	.051	.059	1.30	1.50
A2	.057	.065	1.45	1.65
b	.035	.045	0.90	1.15
b2	.075	.087	1.90	2.20
b4	.114	.126	2.90	3.20
c	.022	.031	0.55	0.80
D	.780	.799	19.80	20.30
D1	.665	.677	16.90	17.20
E	.610	.622	15.50	15.80
E1	.531	.539	13.50	13.70
e		215 BSC		5.45 BSC
L	.779	.795	19.80	20.20
L1	.134	.142	3.40	3.60
∅P	.126	.134	3.20	3.40
∅P1	.272	.280	6.90	7.10
S	.193	.201	4.90	5.10

IXYS Reserves the Right to Change Limits, Test Conditions, and Dimensions.

IXYS MOSFETs and IGBTs are covered by one or more of the following U.S. patents:	4,835,592	4,931,844	5,049,961	5,237,481	6,162,665	6,404,065 B1	6,683,344	6,727,585	7,005,734 B2	7,157,338B2
	4,860,072	5,017,508	5,063,307	5,381,025	6,259,123 B1	6,534,343	6,710,405 B2	6,759,692	7,063,975 B2	
	4,881,106	5,034,796	5,187,117	5,486,715	6,306,728 B1	6,583,505	6,710,463	6,771,478 B2	7,071,537	

Fig. 1. Output Characteristics @ $T_J = 25^\circ\text{C}$

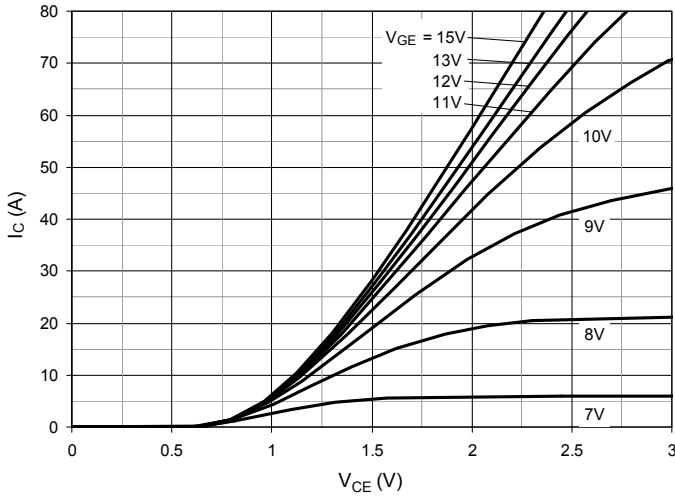

Fig. 2. Extended Output Characteristics @ $T_J = 25^\circ\text{C}$

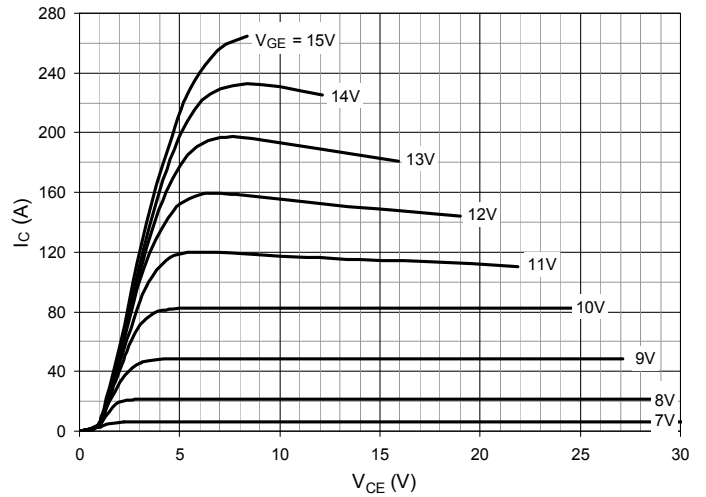

Fig. 3. Output Characteristics @ $T_J = 150^\circ\text{C}$

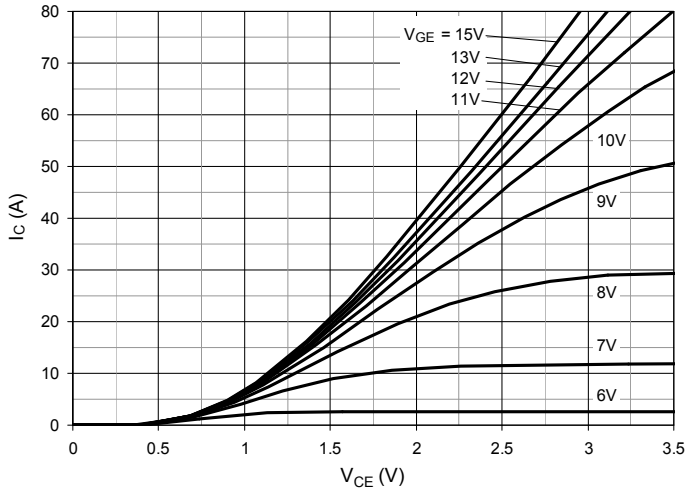

Fig. 4. Dependence of $V_{CE(sat)}$ on Junction Temperature

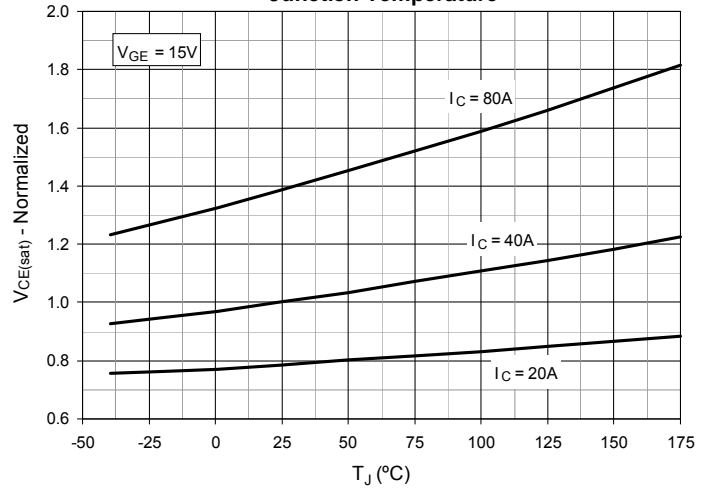

Fig. 5. Collector-to-Emitter Voltage vs. Gate-to-Emitter Voltage

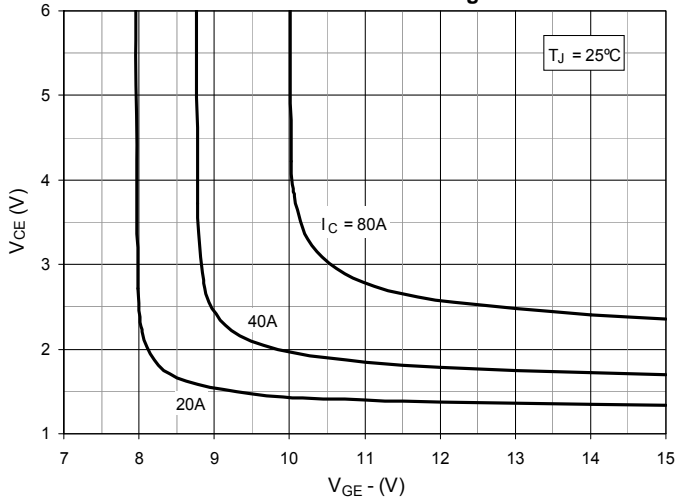

Fig. 6. Input Admittance

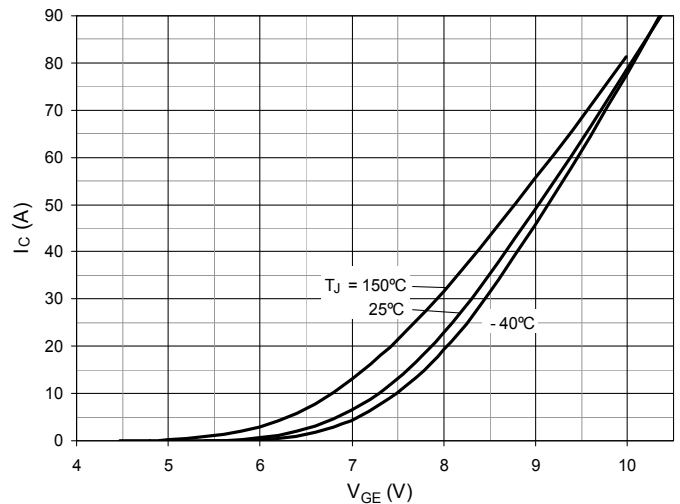

Fig. 7. Transconductance

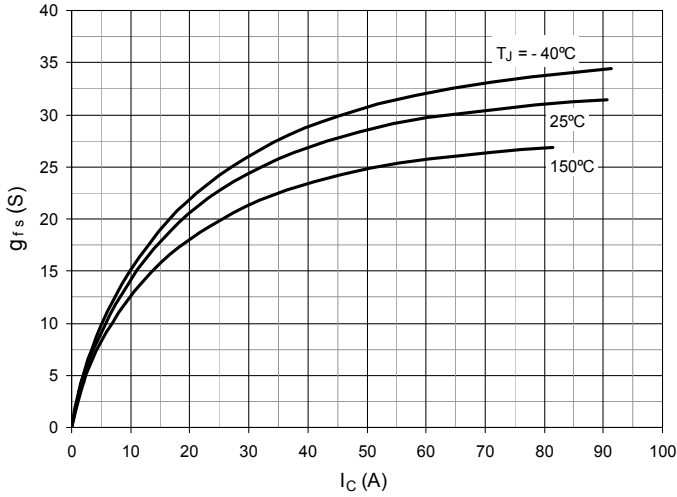

Fig. 8. Gate Charge

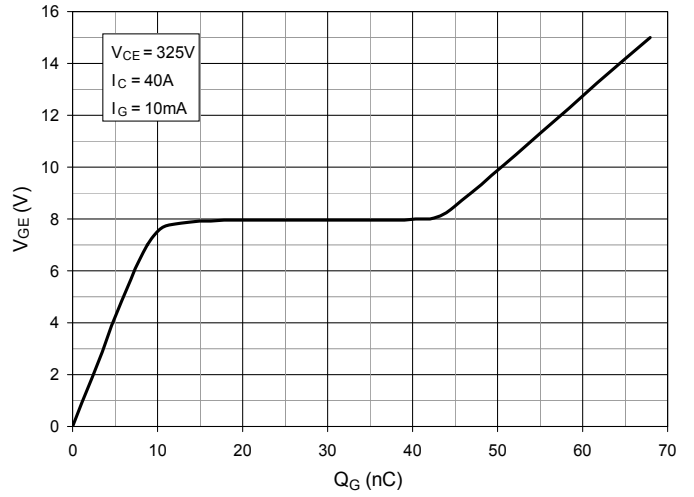

Fig. 9. Capacitance

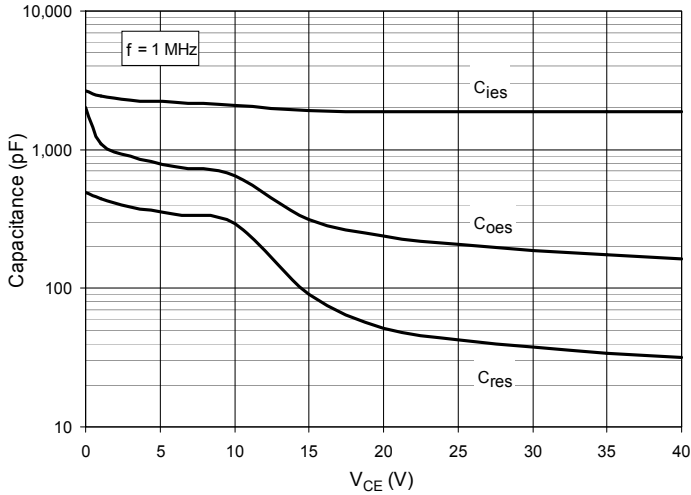

Fig. 10. Reverse-Bias Safe Operating Area

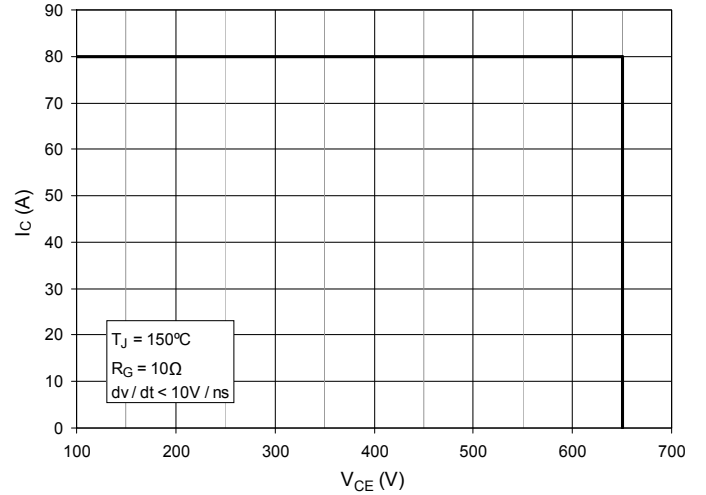

Fig. 11. Forward-Bias Safe Operating Area

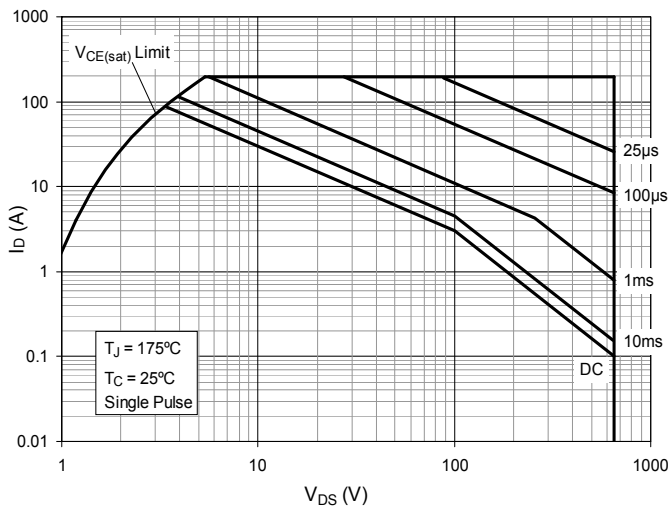

Fig. 12. Maximum Transient Thermal Impedance (IGBT)

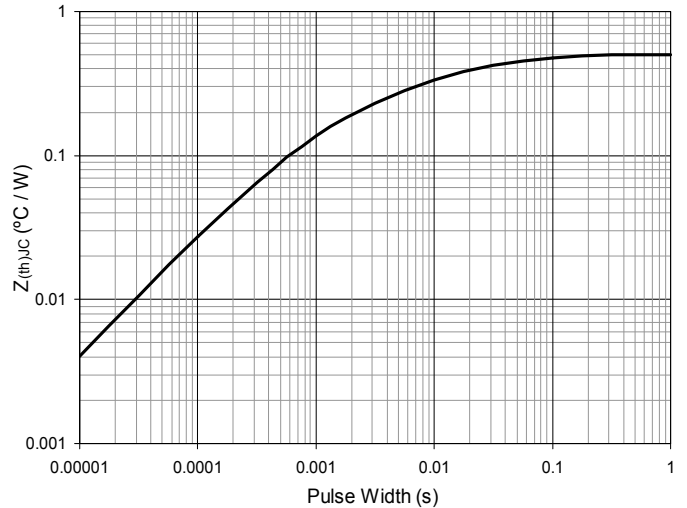

Fig. 13. Inductive Switching Energy Loss vs. Gate Resistance

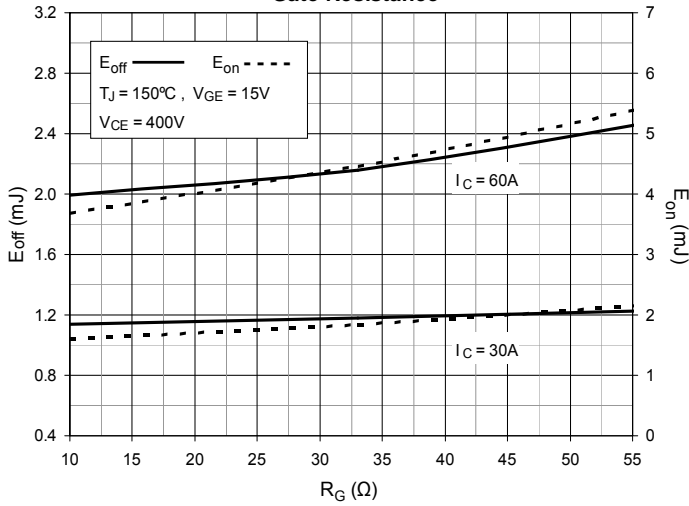

Fig. 14. Inductive Switching Energy Loss vs. Collector Current

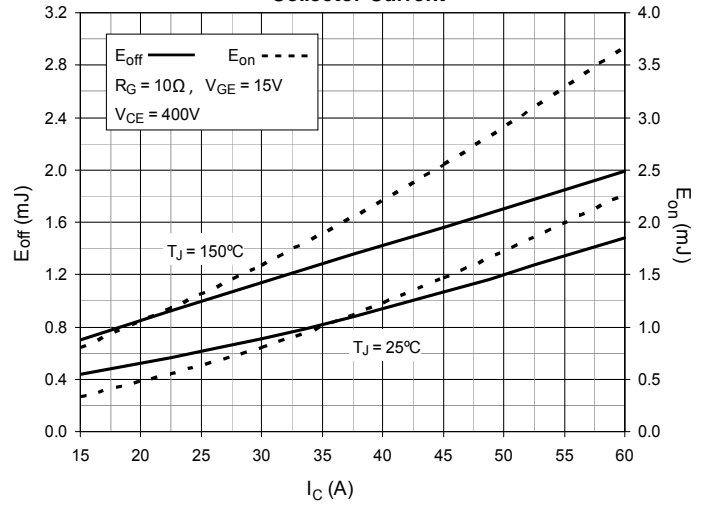

Fig. 15. Inductive Switching Energy Loss vs. Junction Temperature

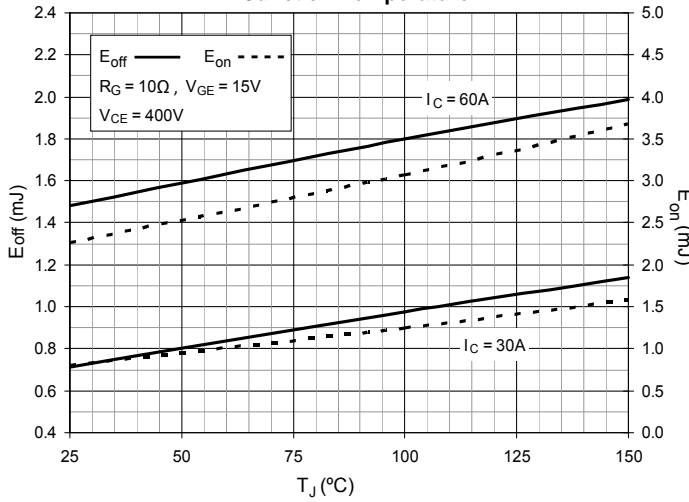

Fig. 16. Inductive Turn-off Switching Times vs. Gate Resistance

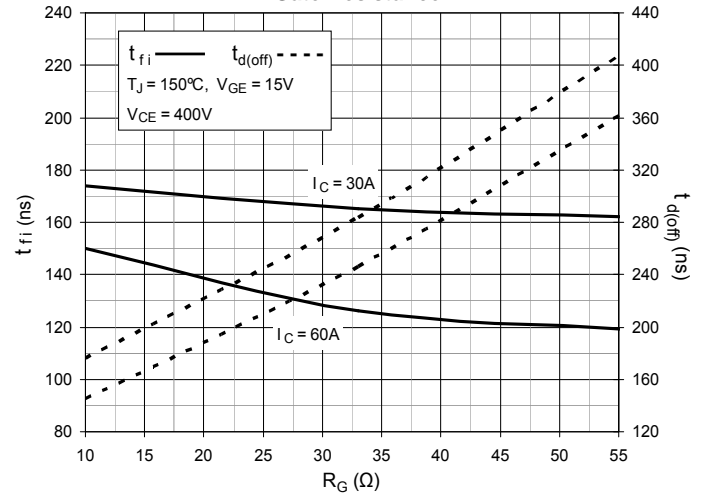

Fig. 17. Inductive Turn-off Switching Times vs. Collector Current

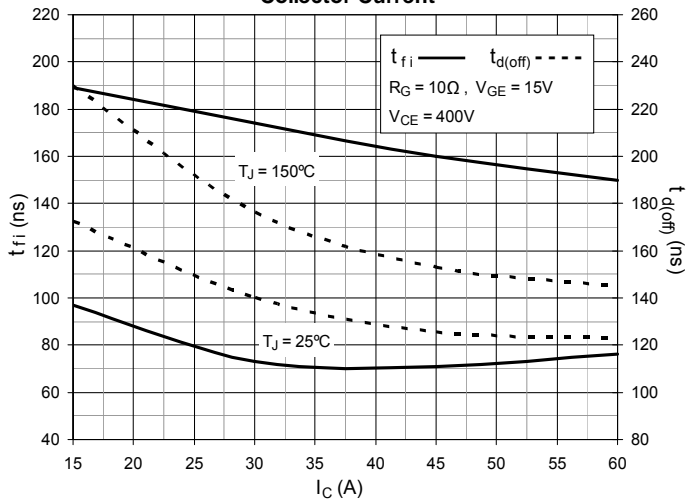

Fig. 18. Inductive Turn-off Switching Times vs. Junction Temperature

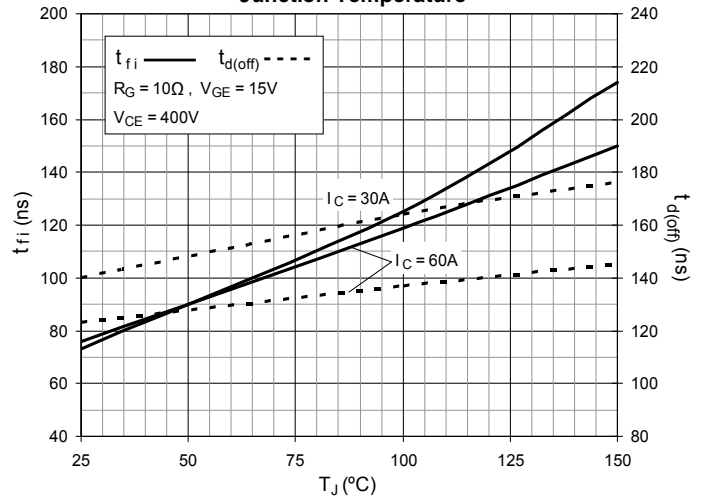

Fig. 19. Inductive Turn-on Switching Times vs. Gate Resistance

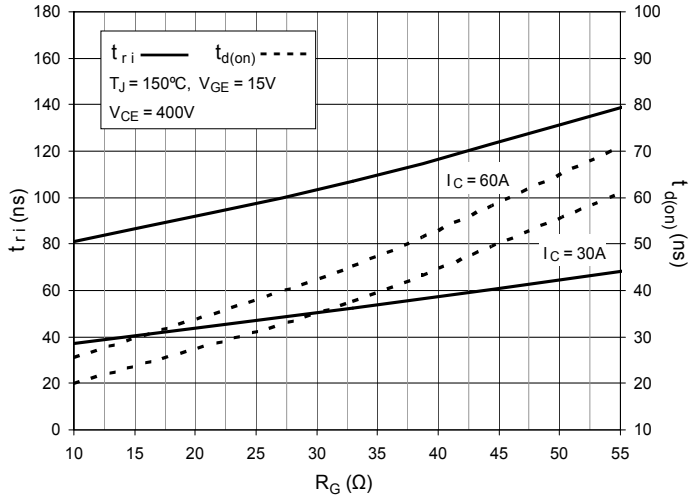

Fig. 20. Inductive Turn-on Switching Times vs. Collector Current

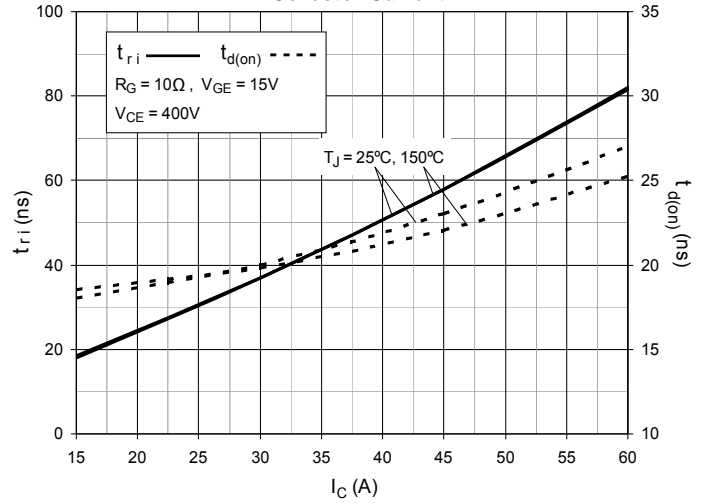

Fig. 21. Inductive Turn-on Switching Times vs. Junction Temperature

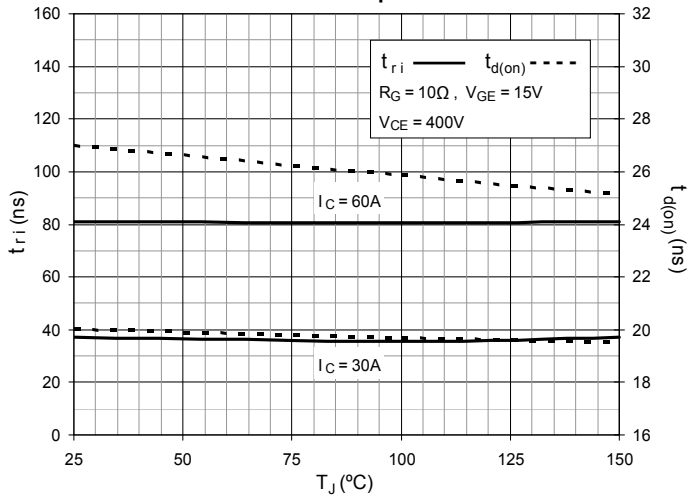

Fig. 22. Diode Forward Characteristics

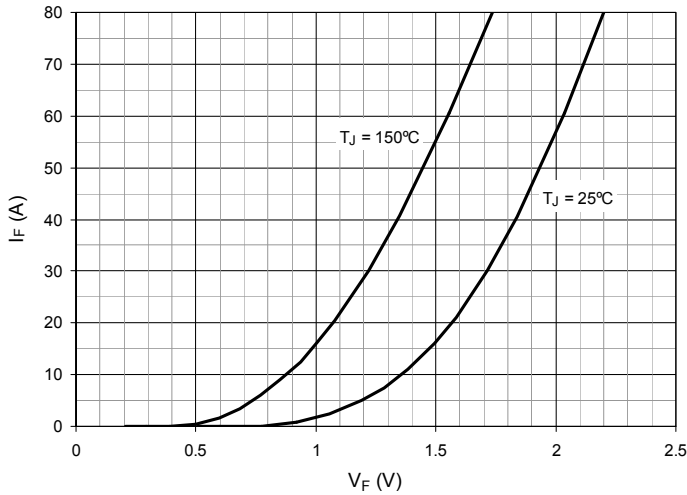

Fig. 23. Reverse Recovery Charge vs. $-di_F/dt$

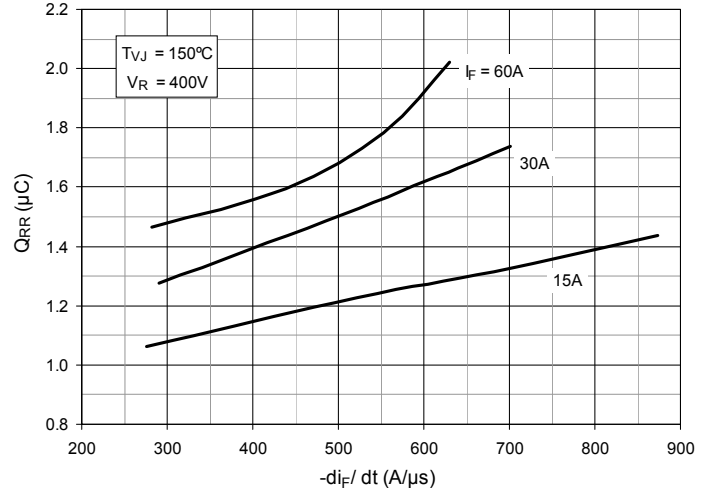

Fig. 24. Reverse Recovery Current vs. $-di_F/dt$

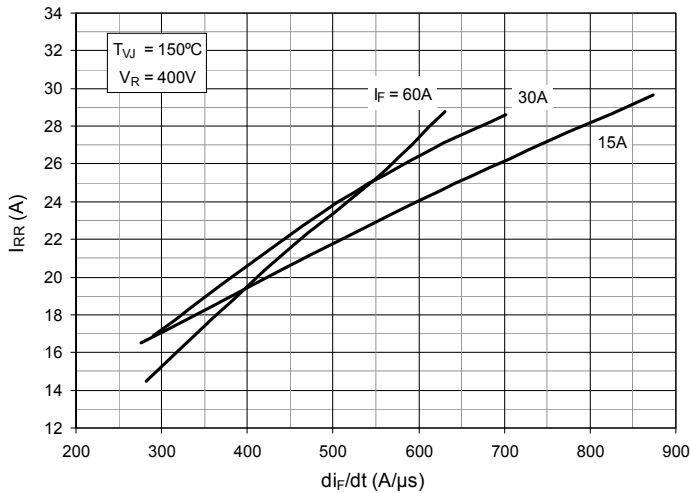

Fig. 25. Reverse Recovery Time vs. $-di_F/dt$

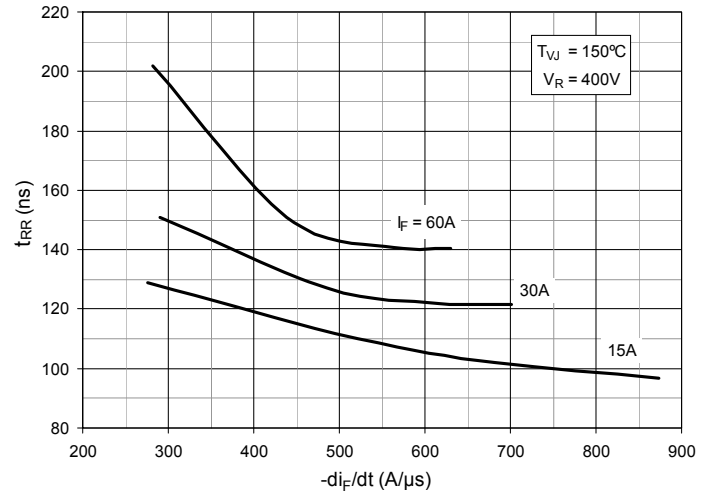

Fig. 26. Dynamic Parameters Q_{RR} , I_{RR} vs. Junction Temperature

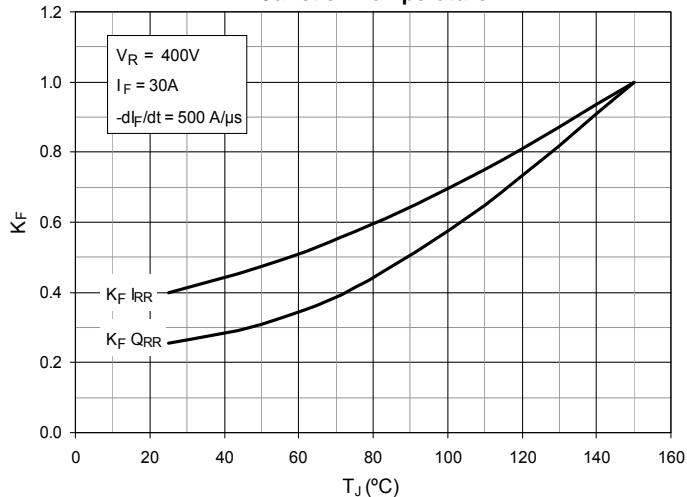
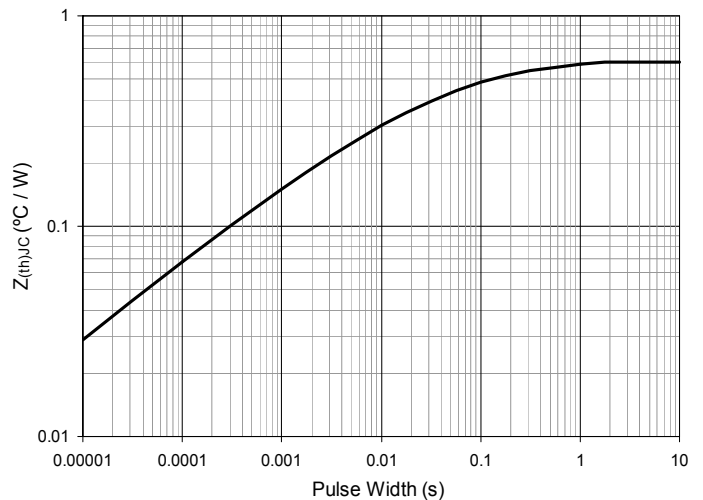

Fig. 27. Maximum Transient Thermal Impedance (Diode)





Disclaimer Notice - Information furnished is believed to be accurate and reliable. However, users should independently evaluate the suitability of and test each product selected for their own applications. Littelfuse products are not designed for, and may not be used in, all applications. Read complete Disclaimer Notice at www.littelfuse.com/disclaimer-electronics.