

**Data sheet | Item number: 280-502/281-602**

Component terminal block; double-deck; with direct connection to DIN rail;  
with P6KE36C TVS diode; 24 VDC; for DIN-rail 35 x 15 and 35 x 7.5; 2.5 mm<sup>2</sup>;  
CAGE CLAMP®; 2,50 mm<sup>2</sup>; gray

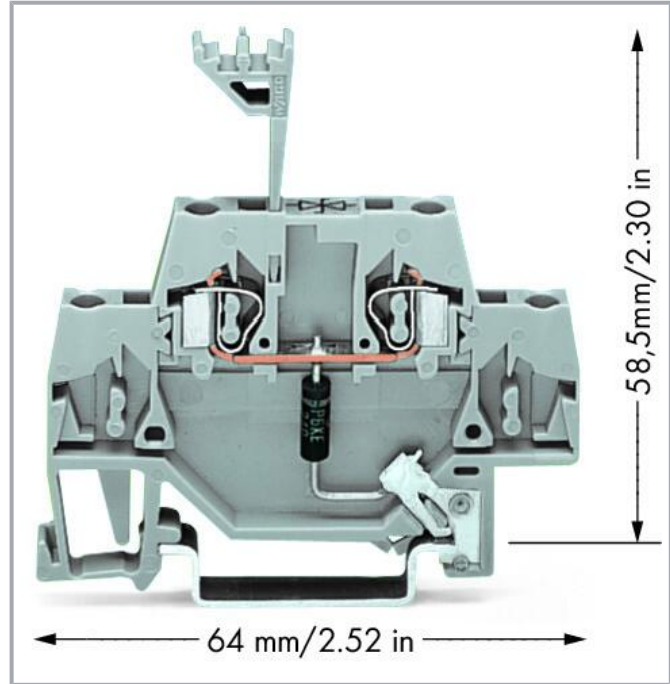

[www.wago.com/280-502/281-602](http://www.wago.com/280-502/281-602)

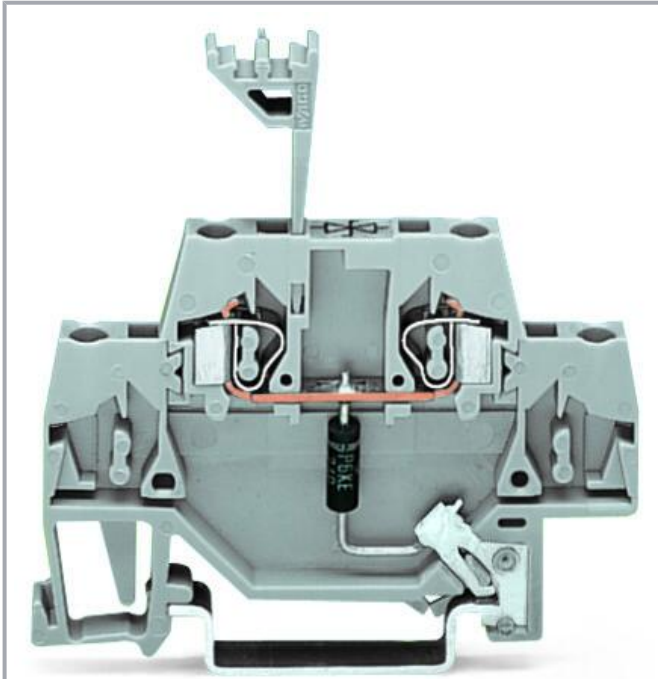

**i** Picture differs from the item.

Color:

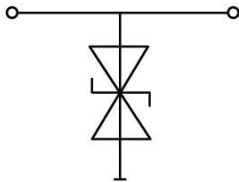

**Item description**

**Short description:**

WAGO's component terminal block with single-stage surge suppression device and direct connection to DIN-35 rail is equipped with a TVS diode.

**Features:**

Subject to changes. Please also observe the further product documentation!

WAGO GmbH & Co. KG  
Hansastr. 27  
32423 Minden  
Phone: +49571 887-0 | Fax: +49571 887-169  
Email: [info.de@wago.com](mailto:info.de@wago.com) | Web: [www.wago.com](http://www.wago.com)

Do you have any questions about our products?  
We are always happy to take your call at +49 (571) 887-44222.



- Protect your system against overvoltage
- Slim, space-saving design
- Control operational costs by preventing expensive, unplanned downtime
- High operational reliability and system uptime

## Data

### Electrical data

Nominal operating voltage	DC 24 V
Highest continuous voltage	DC 30.8 V
Rated continuous current	20 A
Nominal discharge current (10/1000 µs) (line)	12 A
Protection level (10/1000 µs)	≤ DC 50 V
Capacitance	≤ 1000 pF

### Connection data

Connections (number)	2
Connection technology	CAGE CLAMP®
Solid conductor	0.08 ... 2.5 mm <sup>2</sup> / 28 ... 14 AWG
Fine-stranded conductor	0.08 ... 2.5 mm <sup>2</sup> / 28 ... 14 AWG
Strip length	8 ... 9 mm / 0.31 ... 0.35 inches

### Physical data

Width	5 mm / 0.197 inches
Height from upper-edge of DIN-rail	58.5 mm / 2.303 inches
Depth	64 mm / 2.52 inches

### Mechanical Data

Design	with direct connection to DIN-rail
Mounting type	DIN-35 rail

### Material Data

Color	gray
Insulation material	Polyamide (PA66)
Material group	I
Flammability class per UL94	V0

Subject to changes. Please also observe the further product documentation!

Fire load	0.241 MJ
Weight	8.2 g

### Environmental requirements

Processing temperature	-35 ... +85 °C
------------------------	----------------

### Commercial data



Product Group	1 (Rail Mounted Terminal Blocks)
eCl@ss 10.0	27-14-11-27
eCl@ss 9.0	27-14-11-27
ETIM 8.0	EC000903
ETIM 7.0	EC000903
PU (SPU)	50 pcs
Packaging type	box
Country of origin	CN
GTIN	4045454194239
Customs tariff number	85369010000

### Environmental Product Compliance

CAS-No.	7439-92-1
REACH Candidate List Substance	Lead
RoHS Compliance Status	Compliant,With Exemption
RoHS Exemption	6(c) 7(a) 7(c)-I 7(c)-II
SCIP notification number (Bulgaria)	82064447-ea3b-48e1-9857-74193bef869b
SCIP notification number (Czech Republic)	124180cd-d938-4010-abca-c1732caaac99

### Required accessories



#### End plate

End plate		
	Item no.: 280-341 End and intermediate plate; 2.5 mm thick; orange	<a href="http://www.wago.com/280-341">www.wago.com/280-341</a>
	Item no.: 280-340 End and intermediate plate; 2.5 mm thick; gray	<a href="http://www.wago.com/280-340">www.wago.com/280-340</a>







Subject to changes. Please also observe the further product documentation!

## Optional accessories

### Jumpers

Jumper		
	<b>Item no.: 280-492</b> Jumper; 2-way; insulated; gray	<a href="http://www.wago.com/280-492">www.wago.com/280-492</a>
	<b>Item no.: 280-482</b> Jumper; 2-way; insulated; gray	<a href="http://www.wago.com/280-482">www.wago.com/280-482</a>
	<b>Item no.: 280-484</b> Jumper; 4-way; insulated; gray	<a href="http://www.wago.com/280-484">www.wago.com/280-484</a>
	<b>Item no.: 280-490</b> Jumper; 10-way; insulated; gray	<a href="http://www.wago.com/280-490">www.wago.com/280-490</a>
	<b>Item no.: 280-485</b> Jumper; 5-way; insulated; gray	<a href="http://www.wago.com/280-485">www.wago.com/280-485</a>
	<b>Item no.: 280-483</b> Jumper; 3-way; insulated; gray	<a href="http://www.wago.com/280-483">www.wago.com/280-483</a>

### Marking accessories

Marker		
	<b>Item no.: 2009-115</b> WMB-Inline; for Smart Printer; 1500 pieces on roll; stretchable 5 - 5.2 mm; plain; snap-on type; white	<a href="http://www.wago.com/2009-115">www.wago.com/2009-115</a>
	<b>Item no.: 793-501</b> WMB marking card; as card; not stretchable; plain; snap-on type; white	<a href="http://www.wago.com/793-501">www.wago.com/793-501</a>
	<b>Item no.: 793-502</b> WMB marking card; as card; MARKED; 1 ... 10 (10x); not stretchable; Horizontal marking; snap-on type; white	<a href="http://www.wago.com/793-502">www.wago.com/793-502</a>
	<b>Item no.: 793-503</b> WMB marking card; as card; MARKED; 11 ... 20 (10x); not stretchable; Horizontal marking; snap-on type; white	<a href="http://www.wago.com/793-503">www.wago.com/793-503</a>
	<b>Item no.: 793-504</b> WMB marking card; as card; MARKED; 21 ... 30 (10x); not stretchable; Horizontal marking; snap-on type; white	<a href="http://www.wago.com/793-504">www.wago.com/793-504</a>
	<b>Item no.: 793-505</b> WMB marking card; as card; MARKED; 31 ... 40 (10x); not stretchable; Horizontal marking; snap-on type; white	<a href="http://www.wago.com/793-505">www.wago.com/793-505</a>
	<b>Item no.: 793-506</b> WMB marking card; as card; MARKED; 41 ... 50 (10x); not stretchable; Horizontal marking; snap-on type; white	<a href="http://www.wago.com/793-506">www.wago.com/793-506</a>

### Tool

Operating tool		
----------------	--	--

Subject to changes. Please also observe the further product documentation!



**Item no.: 210-720**

Operating tool; Blade: 3.5 x 0.5 mm; with a partially insulated shaft; multicoloured

[www.wago.com/210-720](http://www.wago.com/210-720)

### Insulation stop

Insulation stop



**Item no.: 280-472**

Insulation stop; 0.75 - 1 mm<sup>2</sup>; 5 pieces/strip; black

[www.wago.com/280-472](http://www.wago.com/280-472)



**Item no.: 280-470**

Insulation stop; 0.08 - 0.2 mm<sup>2</sup> "s" (0.14 mm<sup>2</sup> "f-st"); 5 pieces/strip; white

[www.wago.com/280-470](http://www.wago.com/280-470)



**Item no.: 280-471**

Insulation stop; 0.25 - 0.5 mm<sup>2</sup>; 5 pieces/strip; light gray

[www.wago.com/280-471](http://www.wago.com/280-471)

## Downloads

### Documentation

#### Bid Text

280-502/281-602 X81 - Datei	2019 Feb 19	xml 3.4 kB	Download
280-502/281-602 doc - Datei	2015 Feb 11	doc 25.6 kB	Download

#### Additional Information

Disposal and Recycling Electrical and electronic equipment, Batteries, Packaging	V 1.1.0 2022 Aug 18	pdf 2.2 MB	Download
-------------------------------------------------------------------------------------	------------------------	---------------	----------

## CAD/CAE-Data

### CAD data

2D/3D Models 280-502/281-602	URL	Download
------------------------------	-----	----------

### CAE data

EPLAN Data Portal 280-502/281-602	URL	Download
-----------------------------------	-----	----------

WSCAD Universe 280-502/281-602	URL	Download
--------------------------------	-----	----------

ZUKEN Portal 280-502/281-602

Subject to changes. Please also observe the further product documentation!



	URL	Download
EPLAN Data Portal 280-502/281-602	<a href="#">URL</a>	<a href="#">Download</a>
WSCAD Universe 280-502/281-602	<a href="#">URL</a>	<a href="#">Download</a>

## Environmental Product Compliance

### Compliance Search

Environmental Product Compliance 280-502/281-602	<a href="#">URL</a>	<a href="#">Download</a>
Component terminal block; double-deck; with direct connection to DIN rail; with P6KE36C TVS diode; 24 VDC; for DIN-rail 35 x 15 and 35 x 7.5; 2.5 mm <sup>2</sup> ; CAGE CLAMP®; 2,50 mm <sup>2</sup> ; gray		

## Installation Notes

Subject to changes. Please also observe the further product documentation!

WAGO GmbH & Co. KG  
Hansastr. 27  
32423 Minden  
Phone: +49571 887-0 | Fax: +49571 887-169  
Email: [info.de@wago.com](mailto:info.de@wago.com) | Web: [www.wago.com](http://www.wago.com)

Do you have any questions about our products?  
We are always happy to take your call at +49 (571) 887-44222.