

# XL-TankSensor- WRMA™ Series



High Performance, IP67 Weather Resistant, Ultrasonic Range Finder

MB7850<sup>3</sup>

The XL-TankSensor-WRMA sensor series provides users with robust range information in air. The MB7850 sensor is recommended for liquid level measurement usage. This sensor also features high-power acoustic output along with real-time auto sensitivity adjustment for changing conditions (supply voltage sag, acoustic noise, or electrical noise), operation with supply voltage from 3V to 5.5V, object detection from 0-cm to 650-cm, and sonar range information from 5-cm<sup>1</sup> out to 650-cm with 1-cm resolution. Liquids from 0-cm to 5-cm<sup>1</sup> range as 5-cm<sup>1</sup>. The sensor is housed in a robust ABS housing, designed to meet the IP67 water intrusion standard. The top thread is a 3/4"-14 NPS, with the end of the horn being a 2" NPS thread. The user interface formats included are real-time analog-voltage envelope, analog voltage output, and serial output.



A bootloader is available for this part upon request, please contact sales@maxbotix.com

<p><b>Features</b></p> <ul style="list-style-type: none"> <li>• Real-time auto sensitivity adjustment and noise rejection</li> <li>• High acoustic power output</li> <li>• Precise narrow beam characteristics</li> <li>• Liquid detection includes zero range</li> <li>• 3V to 5.5V supply with very low average current draw<sup>2</sup></li> <li>• Free run operation can continually measure and output range information</li> <li>• 4.032Hz refresh rate</li> <li>• Triggered operation provides the range reading as desired</li> <li>• All interfaces are active simultaneously</li> <li>• RS232/TTL Serial, 0 to Vcc, 9600 Baud, 81N</li> <li>• Analog, (Vcc/1024) / cm</li> <li>• Sensor operates at 42KHz</li> </ul>	<p><b>Benefits</b></p> <ul style="list-style-type: none"> <li>• Acoustic and electrical noise resistance</li> <li>• Reliable and stable range data</li> <li>• Robust, low cost IP67 standard sensor</li> <li>• Very low power excellent for battery based systems</li> <li>• Ranging can be triggered externally or internally</li> <li>• Sensor reports the range reading directly, frees up user processor</li> <li>• Easy to install with standard electrical fittings</li> <li>• Filtering allows very reliable operation in most environments</li> </ul> <p><b>Applications and Uses</b></p> <ul style="list-style-type: none"> <li>• Tank level measurement</li> <li>• Environments with acoustic and electrical noise</li> <li>• Liquid Distance Measuring</li> <li>• Industrial sensor -40°C to +65°C <sup>2</sup></li> </ul>	<p><b>Notes:</b></p> <p><sup>1</sup> Minimum distance is 5-cm  <sup>2</sup> Please reference page 8 for minimum operating voltage verses temperature information  <sup>3</sup> Please reference page 11 for part number key</p>
--	---	---

## Close Range Operation

Applications requiring 100% reading-to-reading reliability should not use TankSensors at a distance closer than 5-cm<sup>1</sup>. MaxBotix® Inc. does not guarantee operational reliability for objects closer than the minimum reported distance. Because of ultrasonic physics, these sensors are unable to achieve 100% reliability at close distances.

## Warning: Personal Safety Applications

We do not recommend or endorse this product be used as a component in any personal safety applications. This product is not designed, intended or authorized for such use. These sensors and controls do not include the self-checking redundant circuitry needed for such use. Such unauthorized use may create a failure of the MaxBotix® Inc. product which may result in personal injury or death. MaxBotix® Inc. will not be held liable for unauthorized use of this component.

## XL-TankSensor-WRMA Pin Out

**Pin 1-RX**– This pin is used to receive commands, and it will expect to receive commands in the selected serial format

**Pin 2**– If this pin is left disconnected or held high during power up, the part will output TTL. If this pin is brought low, the part will output RS232. **The sensor will select a serial status ~40mS after applying power.** After this point the status of pin 2 will not be monitored. At this point, this pin outputs the analog voltage envelope of the acoustic waveform. This is a real-time always-active output.

**Pin 3- AN**– This pin outputs analog voltage with a scaling factor of ( $V_{cc}/1024$ ) per cm. A supply of 5V yields ~4.9mV/cm., and 3.3V yields ~3.2mV/cm. Hardware limits the maximum reported range on this output to ~780 cm at 5V and ~600 cm at 3.3V. The output is buffered and corresponds to the most recent range data.

**Pin 4**- This pin is internally pulled high. If Pin-4 is left unconnected or held high, the sensor will continually measure the range. If Pin-4 is held low the sensor will stop ranging. Bring high 20uS or more to command a range reading.

**Pin 5- TX**– This pin output delivers asynchronous serial data in an RS232/TTL format, except the voltages are 0-V<sub>cc</sub>. The output will begin with an ASCII capital “R”, followed by ASCII character digits representing the range in centimeters up to a maximum of 650 or if no target is detected 999. Then followed by an ASCII space character and an ASCII capital “T” then delivering ASCII character digits representing the teach confidence as a percentage from 0-100. Finally ending in an ASCII carriage return (Decimal 13, \R)

Example: R650 T100\R or R999 T100\R

The baud rate is 9600, 8 bits, no parity, with one stop bit. Although the voltages of 0V to V<sub>cc</sub> are outside the RS232\* standard, most RS232\* devices have sufficient margin to read the 0V to V<sub>cc</sub> serial data. If standard voltage level RS232\* is desired, invert, and connect an RS232\* converter such as a MAX232.

**V+** Operates on 3V - 5.5V. The average (and peak) current draw for 3.3V operation is 1.6mA (27mA peak) and 5V operation is 1.8mA (47mA peak) respectively. Peak current is used during sonar pulse transmit. Please reference page 8 for minimum operating voltage verses temperature information.

**GND**-Return for the DC power supply. GND (& V+) must be ripple and noise free for best operation.

---

## About Ultrasonic Sensors

Our ultrasonic sensors are desired for use in air, non-contact object detection and ranging sensors that detect objects within a defined area. These sensors are not affected by the color or other visual characteristics of the detected object. Ultrasonic sensors use high frequency sound to detect and localize objects in a variety of environments. Ultrasonic sensors measure the time of flight for sound that has been transmitted to and reflected back from nearby objects. Based upon the time of flight, the sensor then outputs a range reading.

---

## Auto Sensitivity Adjustment

Each time before the XL-TankSensor-WRMA takes a range reading it auto calibrates. The sensor then uses this data to range objects. If the temperature, humidity, or applied voltage changes during sensor operation, the sensor will continue to function normally. (The sensors do not apply compensation for the speed of sound change verses temperature to any range readings.)

---

## Supply Voltage Compensation

During power up, the XL-TankSensor-WRMA sensor line will calibrate itself for the supply voltage. Additionally, the sensor will compensate if the supplied voltage gradually changes.

If the average voltage applied to the sensor changes faster than 0.5V per second, it is best to remove and reapply power to the sensor. For best operation, the sensor requires noise free power. If the sensor is used with noise on the supplied power or ground, the accuracy of the readings may be affected. Typically, adding a 100uF capacitor at the sensor between the V+ and GND pins will correct most power related electrical noise issues.

---

## Real-time Noise Rejection

While the XL-TankSensor-WRMA is designed to operate in the presence of noise, best operation is obtained when noise strength is low and desired signal strength is high. Hence, the user is encouraged to mount the sensor in such a way that minimizes outside acoustic noise pickup. In addition, keep the DC power to the sensor free of noise. This will let the sensor deal with noise issues outside of the user's direct control (Even so, in general, the sensor will still function well even if these things are ignored). Users are encouraged to test the sensor in their application to verify usability.

---

## Sensor Minimum Distance

The XL-TankSensor-WRMA sensors have a minimum reported distance of 5-cm (1.96 inches). However, the XL-TankSensor-WRMA will range and report targets to the front of the horn. Liquid levels closer than 5-cm will typically range as 5-cm.

---

## WR Exposed Materials

The exposed materials of a properly mounted TankSensor are: Parylene coating applied to the surface of the aluminum transducer (helps to improve the corrosion resistance of the aluminum transducer), ABS, & silicone rubber (VMQ).

---

## Additional Options for Purchase

Please contact MaxBotix for any additional information regarding the options listed below at [info@maxbotix.com](mailto:info@maxbotix.com).

### F-Option

In addition to the standard MaxSonar WR, MaxBotix Inc. has developed the F-Option for additional protection necessary in a few hazardous chemical environments. Extremely corrosive gases or liquids can degrade or compromise the operation of the sensing unit. As a result, we offer a more chemically inert seal which allows our sensors to operate in all but the harshest of chemical environments. In addition to the chemical resistance, the sensor has improved performance in wet environments.

The exposed materials of a properly mounted TankSensor with the F-Option added are: Parylene, ABS, & Fluorosilicone O-Ring. (with an additional back up FEP Teflon® seal).

**Please Note:** Our sensors are designed for operation in normal atmosphere (air). Please be aware that the speed of sound and atmospheric attenuation may change as a result of the transmission properties of different chemical/air mediums. Users are strongly encouraged to characterize and test the operation of the sensor in the new medium to verify operation and properly scale the outputted range information.

---

## Shielded Cable Attach Option

For simple integration of our sensors into end-user applications, MaxBotix has developed the Shielded Cable Attach Option to create a completely IP67 rated TankSensor. The standard Shielded Cable Attach Option uses 3 feet of the MaxSonar MB7954 Shielded Cable (MB7984 when attached by MaxBotix) with an epoxy filled cap to fully protect the pin-out of the TankSensor. Additional cable length can be specified and purchased using part number MB7984.

### Mechanical Dimensions

The sensor is housed in a robust ABS housing, designed to meet the IP67 water intrusion standard. The top thread is a 3/4"-14 NPS, with the end of the horn being a 2" NPS thread.

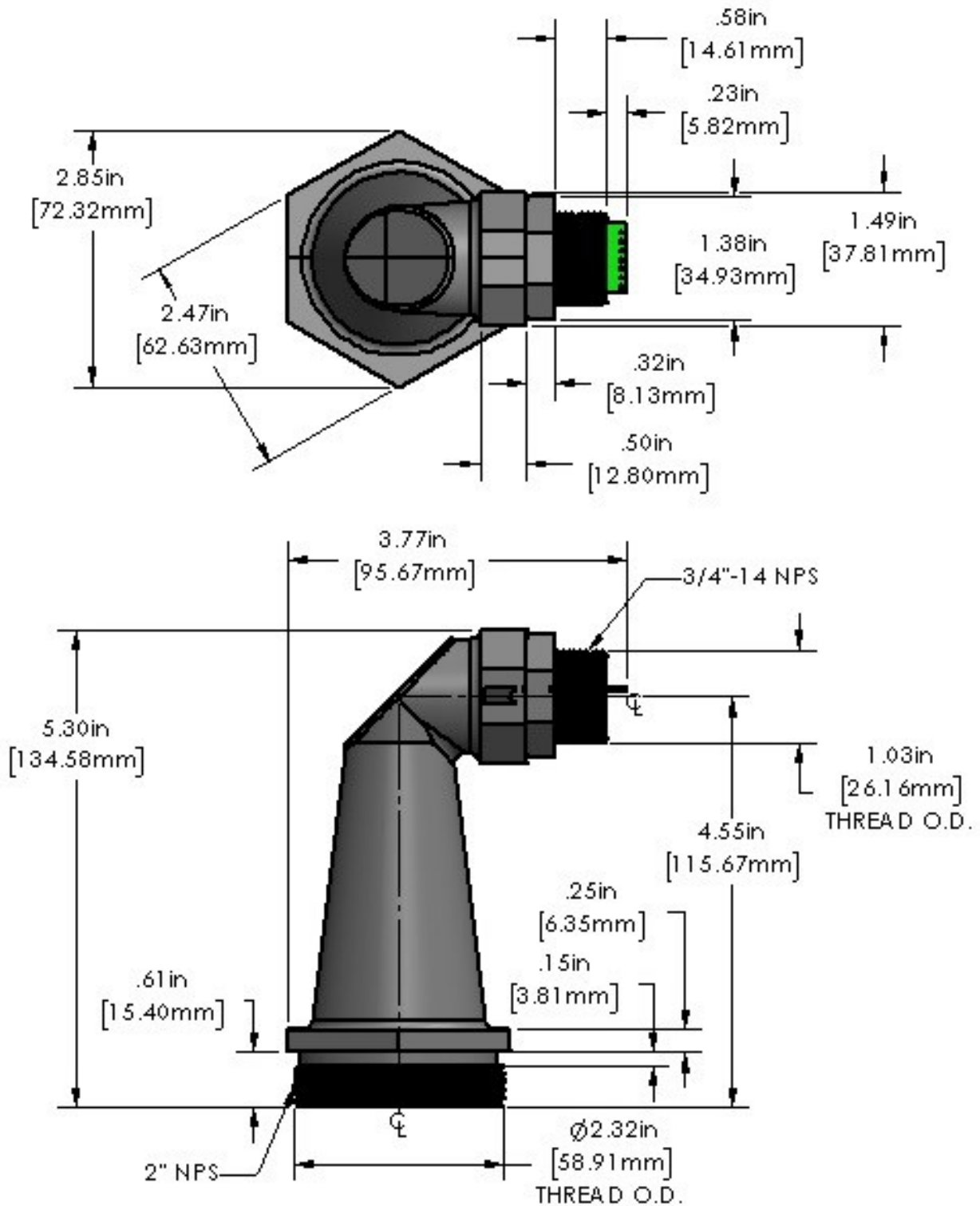

Weight is 80 grams

## Serial Command Operation

A bootloader is available for this part upon request, please contact sales@maxbotix.com.

### Command Information

Commands must be sent in the 10mS following the final character of the reported range data. If a command is sent after 10mS the command will be ignored. The final character of the range data will be a carriage return (decimal 13 or hex 0xc). Below is the list of all available commands.

Command Character	Effect
"T" or "t"	<p align="center"><b>Save New Calibration</b></p> <p>This command is recommended to be used to store information on what the empty tank looks like. This is used to improve the reliability of short range readings. <b>This command should only be used in empty tanks</b> or when there is no target within one meter of the sensor. One of the serial outputs is a teach confidence output value. If that number drops below 75%, <b>we would recommend retraining the sensor when the tank is emptied.</b> Teaching the sensor will bring this teach confidence output near 100%.</p>
"R" or "r"	<p align="center"><b>Restore Factory Calibration</b></p> <p>If a bad teach value is sent to the sensor, and you need to restore a known value. This command restores the calibration values that were set in the factory.</p>
"M" or "m"	<p align="center"><b>Set Max Range</b></p> <p>This command will expect to receive three ASCII number characters to set the max range. It is recommended to set this to the height of the tank. This command is limited to 75cm - 650cm. Values outside of this range will be limited to this range. This command can be used regardless of fill status of the tank.</p>
"A"	<p align="center"><b>Analog Envelope ON</b></p> <p>This command can be used to output advanced debug information from the sensor. This data contains an acoustic waveform. This information can be sent to MaxBotix for assistance in troubleshooting advanced problems.</p>
"a"	<p align="center"><b>Analog Envelope OFF</b></p> <p>This command turns off the debug information. Power cycling the sensor also has the same effect.</p>
"D"	<p align="center"><b>Advanced Range ON</b></p> <p>This command can be used to output advanced range information.</p>
"d"	<p align="center"><b>Advanced Range OFF</b></p> <p>This command turns off advanced range information.</p>

### Advanced Range Information

Below is the description of outputs when advanced range information is turned on.

Leading Character	Description
"V"	This value is a filtered expected range value for comparison testing.
"F"	This value is the first attempt range reading detected using the long range algorithm.
"S"	This value is the range of a second chance test to find targets if none were found on first range reading.
"d"	This value is the range returned if the sensor believes the first range reading may have been a secondary reflection.
"I"	This value compares the reported first range reading and the short range reading.
"S"	This value is the short range reading value (taken using a separate ranging algorithm).
"T"	This value is the three digit teach confidence level for the training/calibration of the sensor.
<b>Final Character</b>	This value will be a carriage return.

**Note:** If a test is not ran, the range output will be 000. If no target is found the range output will be 999.

## Range “0” Location

The XL-TankSensor-WRMA sensors reports the range to distant targets starting from the front of the sensor as shown in the diagrams below.



The range is measured from the front of the horn to the target.

## XL-TankSensor-WRMA Sensor Operating Modes

### Independent Sensor Operation

The XL-TankSensor-WRMA sensor is designed to operate in a single sensor environment. Free-run is the default mode of operation for all of the MaxBotix Inc., sensors. XL-TankSensor-WRMA sensors have three separate outputs that update the range data simultaneously: Analog Voltage, Analog Voltage Envelope, and RS232/TTL Serial. Below is a diagram on how to connect the sensor for serial communication.

### Multiple Sensor Operation

When using multiple tank sensors in a single tank, there can be interference (cross-talk) from the other sensors, therefore each sensor should be isolated into their own tank, to avoid ranging interference. Below is a diagram on how to connect multiple sensors to one controller. **Testing is recommend to verify what method will work for your application.**

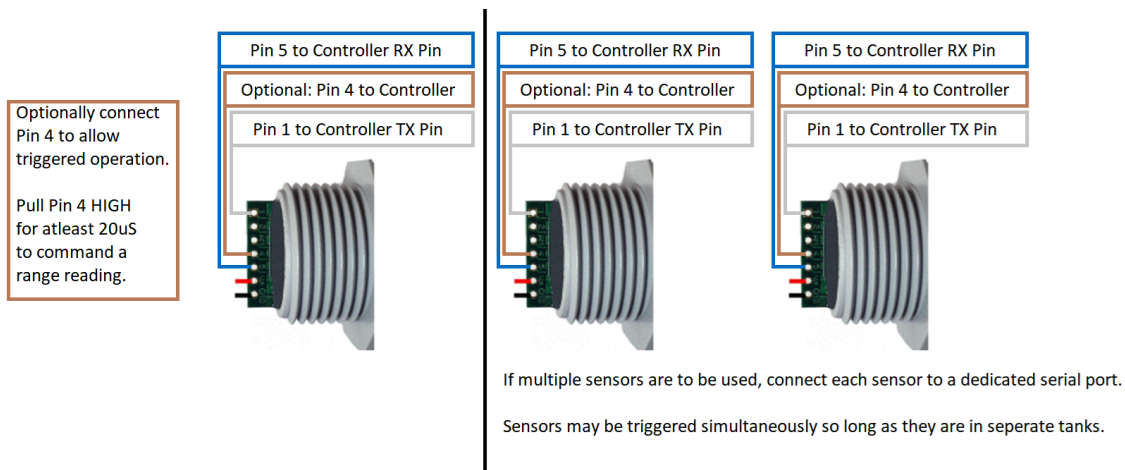

# Sensor Timing Diagrams

## Power-Up Timing

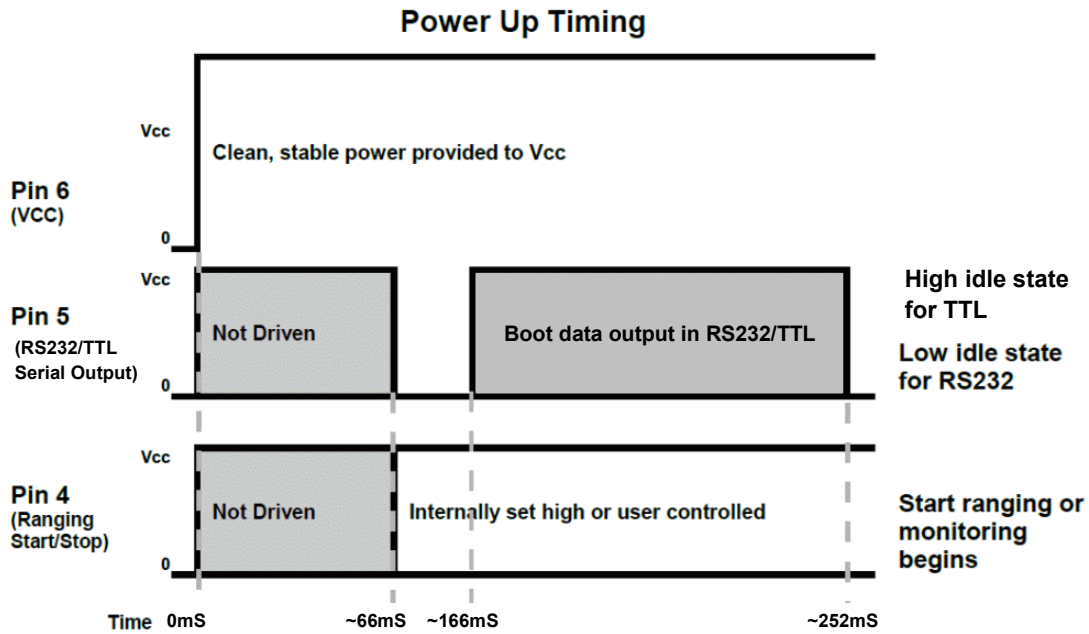

## Sensor Free-Run Timing

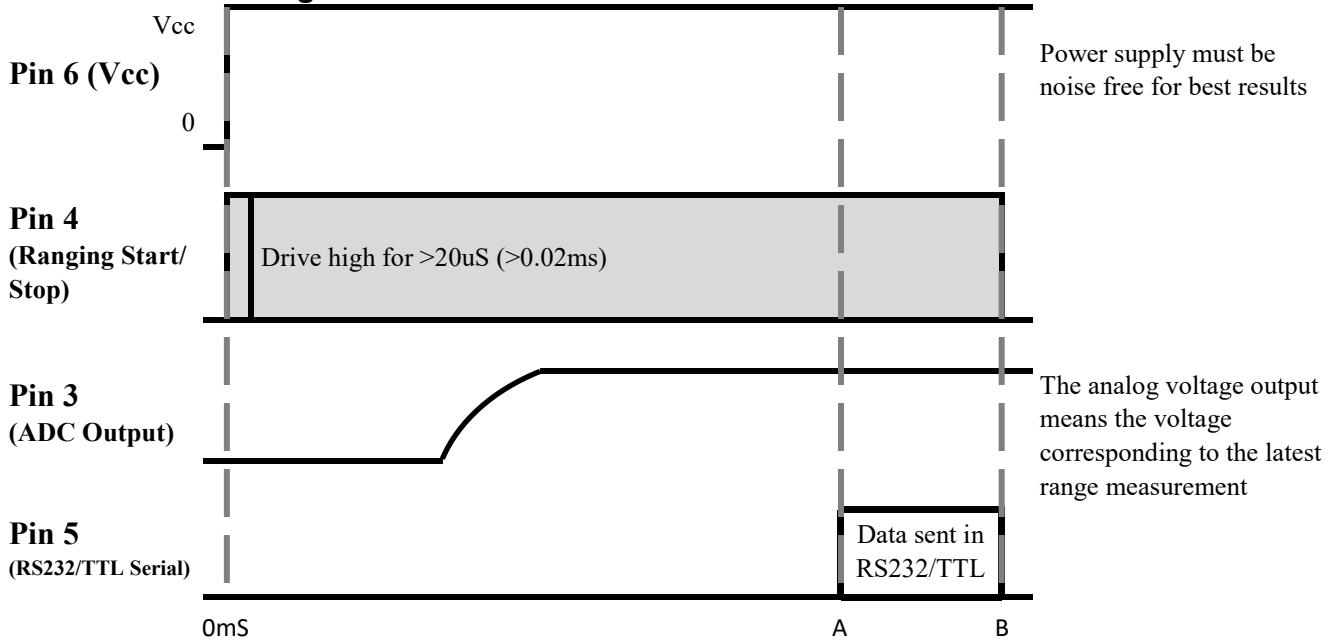

Product	Maximum Refresh Rate	Serial Data Reported (A)	End of Range Cycle (B)
MB7850	4.032 Hz	~236.14mS	~248mS

## Timing Description

253mS after power-up, the XL-TankSensor-WRMA is ready to begin ranging. If Pin-4 is left open or held high (20uS or greater), the sensor will take a range reading. The XL-TankSensor-WRMA checks Pin-4 at the end of every cycle. Range data can be acquired once every period. Each period starts by Pin-4 being high or open, after which the XL-TankSensor-WRMA calibrates and calculates for 20.5mS, and after which, the 42KHz waves are sent. The sensor then determines the range to the target. Next the analog voltage is set. Then serial data is sent<sup>1</sup>. The most accurate range output on the XL-TankSensor-WRMA sensors is the serial output.

*Note 1: Reference the timing specifications on page 7 for the exact times.*

The TankSensor has analog envelope output, Pin-2 will show the real-time signal return information of the Analog Waveform.

## Voltage vs Temperature

The graph below shows minimum operating voltage of the sensor verses temperature.

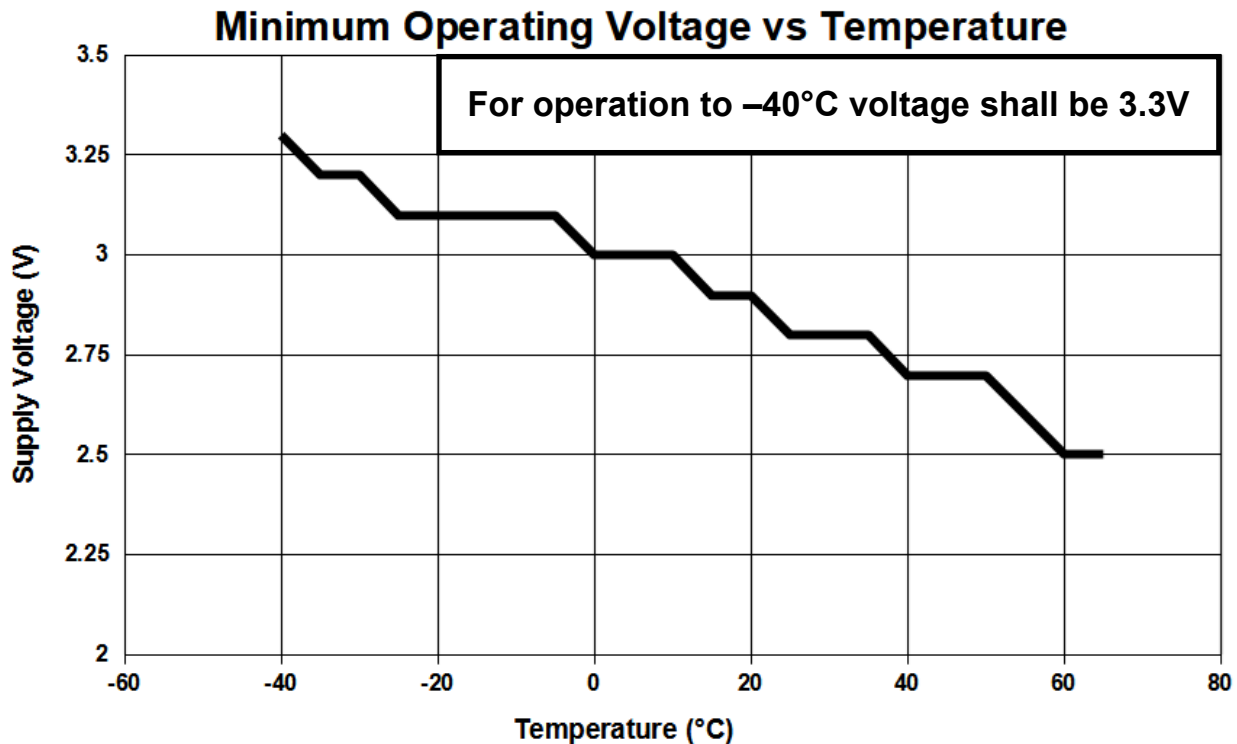



## Attenuation of Ultrasound

Attenuation, specifically absorption of sound through the air, restricts the maximum range of ultrasonic rangefinders. As sound waves travel through the air, that air absorbs some of their energy. High frequency sounds like ultrasound are often attenuated more quickly than lower frequency sounds. In addition to frequency, relative humidity also affect attenuation. Warm air masses with low relative humidity will typically attenuate sound waves faster. As such performance of ultrasonic devices may be limited at low relative humidity, especially when trying to detect targets at longer ranges

## Background Information Regarding our Beam Patterns

Each XL-TankSensor-WRMA sensor has an individually calibrated beam pattern, and is matched to provide the approximate detection pattern shown in this datasheet. This allows end users to select the part number that matches their given sensing application. Each part number has a consistent field of detection so additional units of the same part number will have similar beam patterns. The beam plots are provided to help identify an estimated detection zone for an application based on the acoustic properties of a target versus the plotted beam patterns.

Each beam pattern is a 2D representation of the detection area of the sensor. The beam pattern is actually shaped like a 3D cone (having the same detection pattern both vertically and horizontally). Detection patterns for dowels are used to show the beam pattern of each sensor. Dowels are long cylindered targets of a given diameter. The dowels provide consistent target detection characteristics for a given size target which allows easy comparison of one TankSensor to another TankSensor.

For each part number, the five patterns (A, B, C, D and E) represent the detection zone for a given target size. Each beam pattern shown is determined by the sensor’s part number and target size.

The actual beam angle changes over the full range. Use the beam pattern for a specific target at any given distance to calculate the beam angle for that target at the specific distance. Generally, smaller targets are detected over a narrower beam angle and a shorter distance. Larger targets are detected over a wider beam angle and a longer range.

## Beam Pattern Target Shapes

A 6.1-mm (0.25-inch) diameter dowel 4ft length

B 2.54-cm (1-inch) diameter dowel 4ft length

C 8.89-cm (3.5-inch) diameter dowel 4ft length

D 11-inch wide board 4ft in length moved left to right with the board parallel to the front sensor face. This shows the sensor’s range capability.

E 2” x 2” Cube Corner Reflector

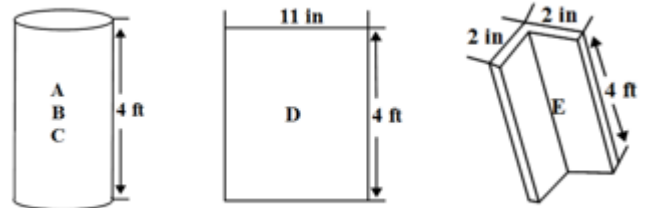

## Corner Reflectors

Sometimes when using an ultrasonic sensor, users experience detection of unwanted objects that appear outside the expected beam pattern. These types of detections are the result of reflectors present in the environment. Corner reflectors can be surprisingly small, yet present a large reflection back to the sensor. Certain objects are prone to causing corner reflections. One of the most common corner reflectors is two flat surfaces joining together to create a 90° angle. A half-circle also acts as a similar reflector. You can learn more about corner reflectors in our [Cube Corner Reflectors](#) article.

# MB7850 XL-TankSensor-WRMA™ Beam Pattern and Uses

The XL-TankSensor-WRMA detects liquid from 0-cm to 650-cm (21 feet) and provides range information from 5-cm to 650-cm with a 1-cm resolution. This sensor is designed for applications where liquid level detection is needed out to a maximum of 6.5 meters.

## MB7850-BXX

### XL-TankSensor-WRMA™ Beam Pattern

Sample results for measured beam pattern are shown on a 30-cm grid. The detection pattern is shown for dowels of varying diameters that are placed in front of the sensor.

- A 6.1-mm (0.25-inch) diameter dowel
- B 2.54-cm (1-inch) diameter dowel
- C 8.89-cm (3.5-inch) diameter dowel
- D 11-inch wide board moved left to right with the board parallel to the front sensor face. This shows the sensor's range capability.
- E 2" x 2" Cube Corner Reflector

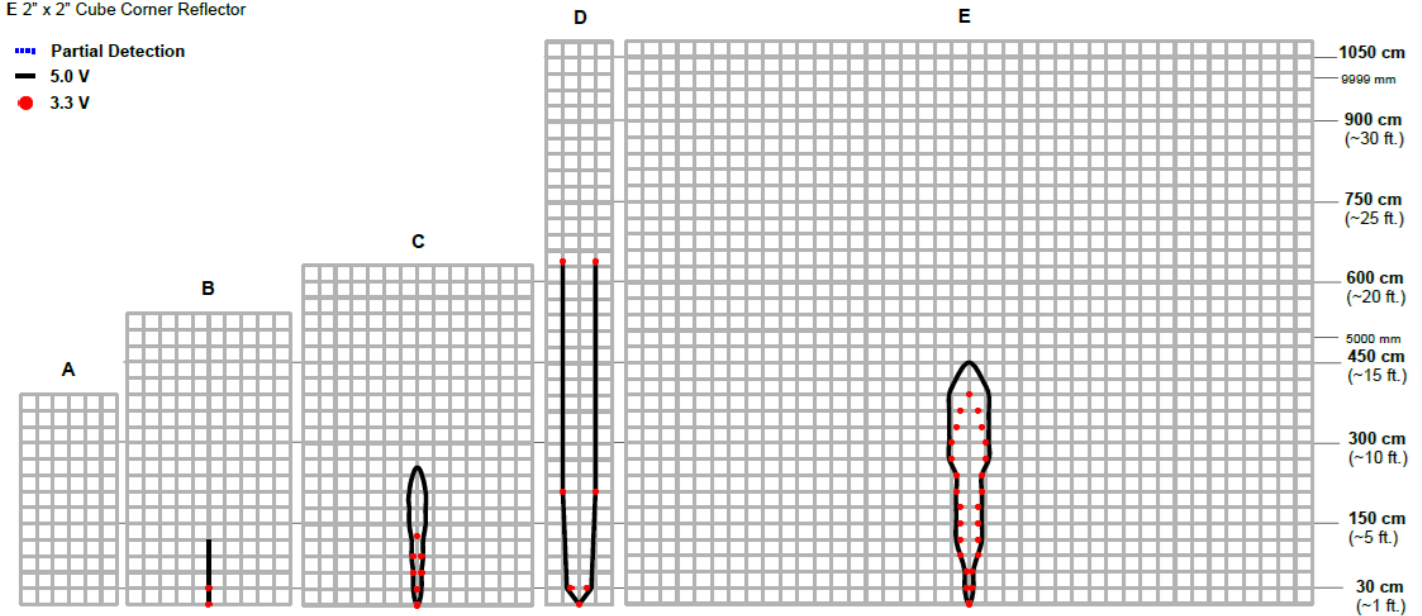
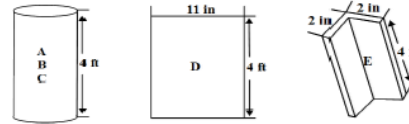

Beam Characteristics are Approximate

Beam Pattern drawn to a 1:95 scale for easy comparison to our other products.

### MB7850

#### Features and Benefits

- 6.5 meter range detection and outputs
- High acoustic power output
- Readings can occur up to every 248ms, 4.032Hz rate
- Triggered operation provides the range reading as desired
- Fast measurement cycle
- Quality narrow beam characteristics
- Low cost, long range IP67 sensor

### MB7850

#### Applications and Uses

- Liquid Distance Measuring
- Long range object detection
- Industrial sensor

### Part Numbers

All part numbers are a combination of a six-character base followed by a dash and a three-digit product code. Please review the following table for more information on the three-digit product code.

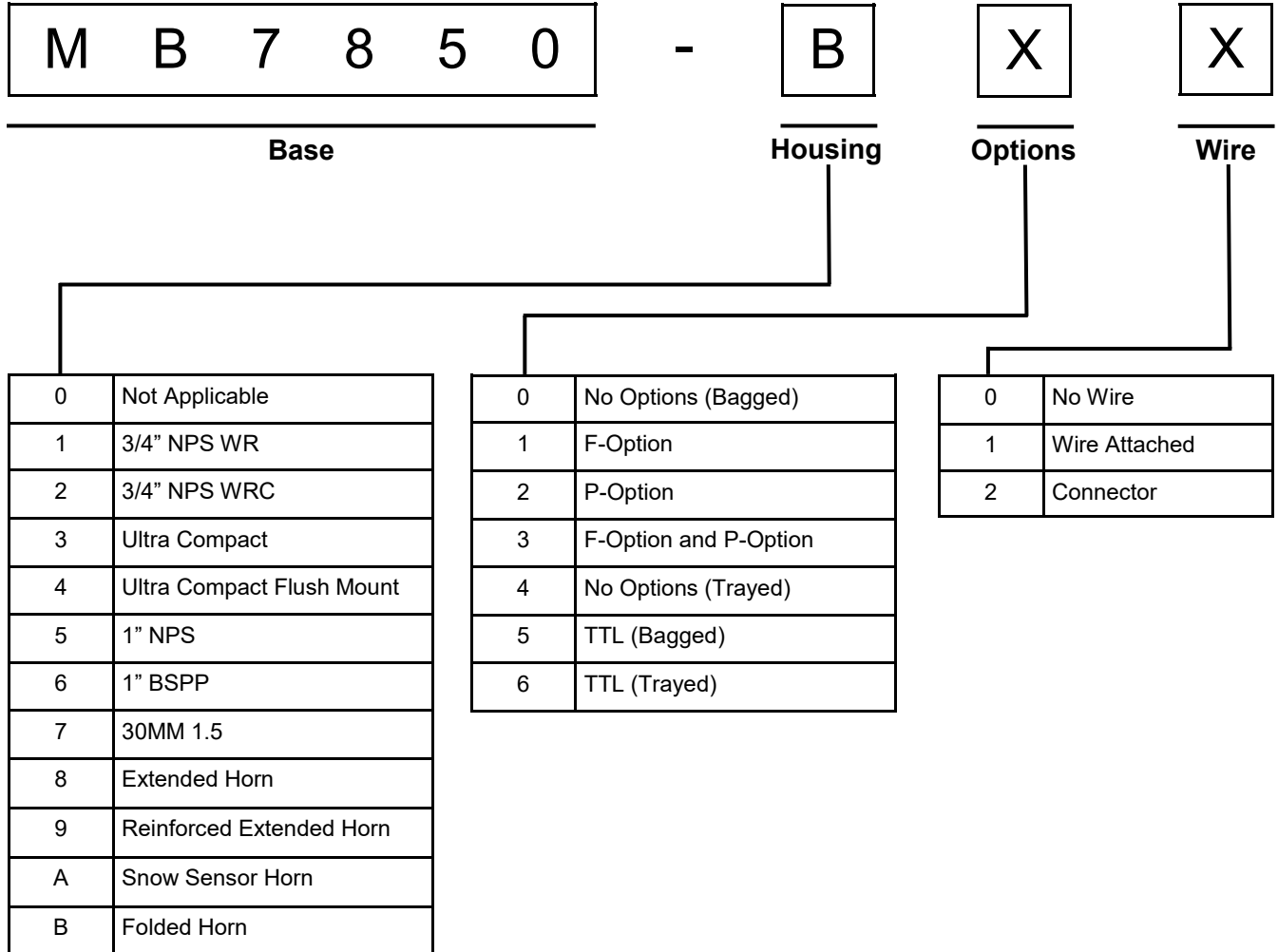

The following tables display all of the active and valid part numbers for these products.

Active Part Numbers for MB7850							
MB7850-B20	MB7850-B21	MB7850-B30	MB7850-B31				

---

## After reviewing this datasheet, do you have any more questions?

We offer Technical Support on all of our products even if you purchased them through one of our many vendors worldwide.

You can **fill out a Technical Support form** for assistance on a sensor here --> [Technical Support](#)

## Not sure which sensor you need for your application?

We offer Sensor Selection Assistance, click the link here to fill out a form for support --> [Sensor Selection Help](#)

## Looking for tutorials to help you get started?

### [Frequently Asked Questions about Our Sensors](#)

We receive many questions about our products and services. This resource offers answers to common inquiries we receive about our product lines and their application.

### [Fully Calibrated Beam Patterns](#)

All of our sensors are factory calibrated to provide consistent beam patterns, detection zones, to fit into a wide variety of applications. In our product lines, each model number comes with a different beam pattern that reflects the sensitivity and the detection zone of how it sees a target. Additionally, we strive to maintain consistency between our finished products, and you will see little to no deviation between sensors of the same model. This allows you to have confidence in your final application when using multiple sensors.

### [Understanding Range Readings](#)

The success of an application may hinge upon knowing the exact location of a target. However, a sensor may report one meter even if the target is not exactly one meter away from the sensor. Sensor specifications, such as resolution, precision, and accuracy, help you to understand sensor performance.

### [How to Use Multiple Ultrasonic Sensors](#)

This guide covers three ways to run your sensors in a Multiple Sensor environment and issues you may face.

Contact us now with any questions at [sales@maxbotix.com](mailto:sales@maxbotix.com) or call +1-218-454-0766.

Please call during our preferred business hours of 8:00 am – 4:30 pm EST on Monday through Thursday and 8:00 am – 2:00 pm EST on Friday, or you may leave us a voicemail anytime.