



# INSTALLATION INSTRUCTIONS PAP SERIES THREE-PHASE MONITOR RELAYS

January 2023

901-0000-106

## DANGER!



Potentially hazardous voltages are present. Electrical shock can cause death or serious injury. Installation should be done by qualified personnel following all National, State & Local Codes.



**BE SURE TO REMOVE ALL POWER SUPPLYING THIS EQUIPMENT BEFORE CONNECTING OR DISCONNECTING WIRING.**

### Installation, Wiring & Setup

1. Mount the appropriate 8 pin octal socket in a suitable enclosure. **NOTE: a 600V-rated socket such as the Macromatic 70169-D must be used with these products on applications greater than 300V. When making connections to the socket, make sure to match the terminal numbers on the socket to the ones shown on the wiring diagram (the wiring diagram on the relay is the view looking towards the bottom of the relay vs. the top of the socket).** Use one or two #12-22 solid or stranded copper or copper-clad aluminum conductors with terminals on the above Macromatic or Custom Connector sockets—a terminal tightening torque of 12 in-lbs should be used.
2. Initially, set the UNDERVOLTAGE knob to 75% (minimum).
3. Connect the three-phase line-line voltage to terminals indicated on Wiring Diagram on the side of the relay or per diagrams below). A connection to the neutral or ground is not required in Wye systems. **DO NOT** connect output wires to output terminals until later (Step 7).
4. Plug the three-phase monitor relay into the socket, making sure the key on the center post is in the proper orientation before insertion. **If the relay must be removed from the socket, do NOT rock the relay back and forth excessively—the center post could be damaged.**
5. Apply three-phase voltage. The LED indicator should illuminate solid GREEN. If the LED turns RED solid or flashing, a fault condition exists and must be corrected. **Use the LED Status Table at right to determine exact cause of fault.** Make required corrections.
6. REMOVE THREE-PHASE VOLTAGE. Set the UNDERVOLTAGE TRIP knob between 75 and 95% of the line-line voltage setting. This value should be the same as the minimum operating voltage for the equipment to be adequately protected.
7. Connect the output(s) terminal wires to terminals 1, 2 and 8 (or 1,3,4 / 11,8,9 for -11X Series). See Wiring Diagram on the side of the relay or diagrams below.
8. When all connections are made, apply three-phase line-line voltage. The LED indicator should illuminate solid GREEN when all voltage conditions are correct.
9. If the LED does not illuminate solid GREEN during regular operation, a fault condition has occurred. REMOVE THREE-PHASE VOLTAGE, and check for proper phase rotation, presence of all three phases, and low voltage conditions. **Use the LED Status Table at right to determine exact cause of fault.** Correct if necessary. Re-energization is automatic upon correction of the fault condition.

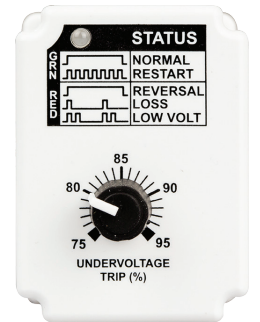

	LED STATUS	STATUS
GREEN		NORMAL (RELAY ON)
		RESTART (DELAY)
RED		REVERSAL
		LOSS
		LOW VOLT (UNDERVOLTAGE)

(Continued on Back)



# INSTALLATION INSTRUCTIONS



## PAP SERIES

### THREE-PHASE MONITOR RELAYS

### Troubleshooting

If the unit fails to operate properly, check that all connections are correct per the appropriate wiring diagram on the product. Check Troubleshooting table below. If problems continue, contact Macromatic at [www.macromatic.com/contact](http://www.macromatic.com/contact) for assistance.

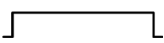
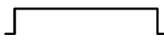
### Troubleshooting Guide

LED STATUS	SITUATION	SOLUTION
GREEN 	Motor is not starting	The relay is in the run mode and working properly. Either another control device is preventing the motor from starting or all wiring should be checked.
NO INDICATION	Relay is not energized and/or motor is not running	Verify L1, L2 and L3 (A, B & C) are connected to input terminals per appropriate diagram below. Measure the three line-to-line voltages. If any of the voltages are below the specified minimum operation voltage, the relay does not have enough power to operate. Check to see why operating voltage is low and correct.
RED 	On power-up or with motor running	The relay is sensing a phase reversal or phase out-of-sequence (rotation) condition. REMOVE THREE-PHASE VOLTAGE and switch any two of the three line connections to ensure the phase sequence (rotation) is correct.
RED 	Phase loss	Make sure all three phases are present. Check for a blown fuse or a loose or broken wire.
RED 	Low voltage (Undervoltage)	Measure the three line-to-line voltages. If the average of these three voltages is below the UNDERVOLTAGE TRIP knob setting, the relay has tripped due to a low voltage condition. Check for low voltage condition and correct it.

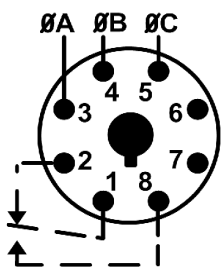

Diagram 23

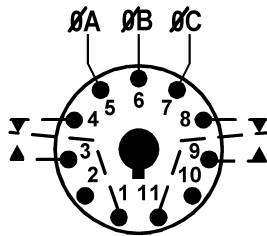
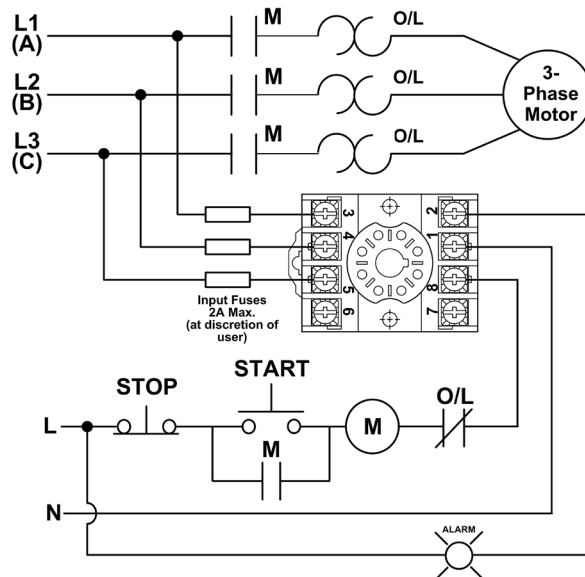

Diagram 173  
PAP - 11X Series

### Typical 8 - pin Connections (For Load Side connection, contact Macromatic)



### Warranty

All catalog-listed PAP Series products manufactured by Macromatic are warranted to be free from defects in workmanship or material under normal service and use for a period of five (5) years from date of manufacture.