

# AFBR-0553Z Evaluation Kit

## DC-to-50 MBd 650-nm Link with RSSI Versatile Link Fiber Optic Evaluation Kit

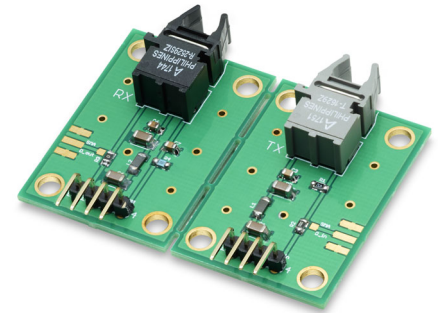

### Introduction

The Broadcom® AFBR-2529SIZ fiber optic receiver features a Receiver Signal Strength Indicator (RSSI). RSSI is a monitoring output that delivers an output current proportional to the average incoming optical power.

The AFBR-0553Z evaluation kit is designed to evaluate the AFBR-2529SIZ with optical transmitter AFBR-1629Z. The evaluation kit is equipped with the documents and accessories necessary for easy use and verification.

### Evaluation Kit

The AFBR-0553Z contains:

- Evaluation board with installed AFBR-2529SIZ and AFBR-1629Z devices
- HFBR-RNS001Z (Plastic Fiber Cable – Standard Attenuation POF, Simplex VL Connectors, 1 Meter)
- AFBR-0553Z User Guide (this document)
- AFBR-1629Z Data Sheet
- AFBR-2529SIZ Data Sheet

### Evaluation Board

The evaluation kit incorporates all of the components required to run the optical link after connecting it to supply voltages and data lines.

The fully assembled evaluation board with separable PCB sections for Rx (AFBR-2529SIZ) and Tx (AFBR-1629Z) is equipped with 4-pin (angled) headers to enable fast and easy connection to pin sockets of peripherals like a single-board computer.

### Applications

Optical receiver AFBR-2529SIZ for 50 MBd systems and below:

- Industrial control and factory automation
- Extension of RS-232 and RS-485
- High-voltage isolation
- Elimination of ground loops
- Reduces voltage transient susceptibility
- Advanced maintenance management of optical links by monitoring the incoming optical receiver power

Transmitter AFBR-1629Z and receiver AFBR-2529SIZ have inverted logic, which results in positive link logic when combined. This means providing LOW electrical TTL input to the transmitter results in LOW electrical TTL output level at the receiver.

**Figure 1: AFBR-0553Z Evaluation Board Schematics**

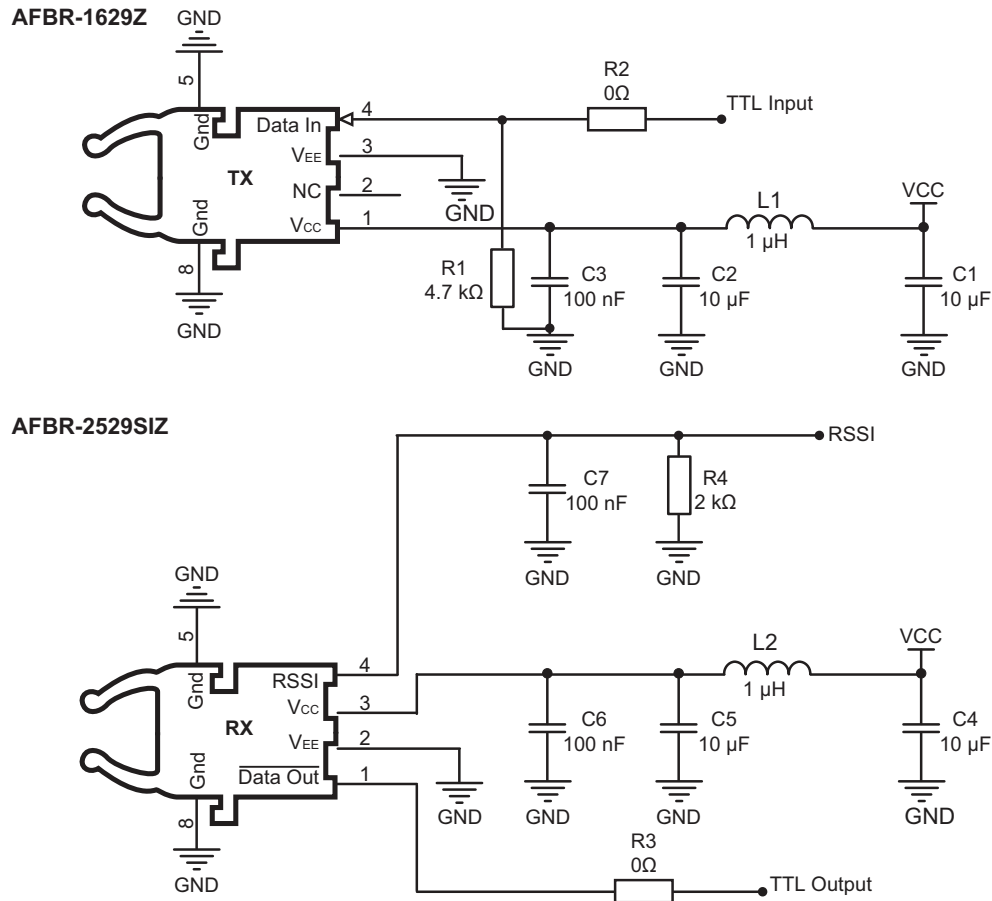

**NOTE:** By changing the position of resistors R2 and R3, the PCB can be modified for 4-pin socket or SMA signal interface operation.

**NOTE:** In case a low impedance load is connected to Data Out (for example, an oscilloscope with 50Ω), exchanging the installed R3 (0Ω) with a higher resistor value (for example, 4.7 kΩ) is strongly recommended.

**Table 1: 4-Pin Header Interfaces**

Pin	TX Section	RX Section
1	Supply Voltage (Vcc)	Data Output (D_out)
2	Not connected (NC)	Ground (GND)
3	Ground (GND)	Supply Voltage (Vcc)
4	Data Input (D_in)	Analog Monitoring Signal (RSSI)

This evaluation kit is equipped with 4-pin header interfaces to allow versatile connectivity, like fast and easy connection to a common single-board computer.

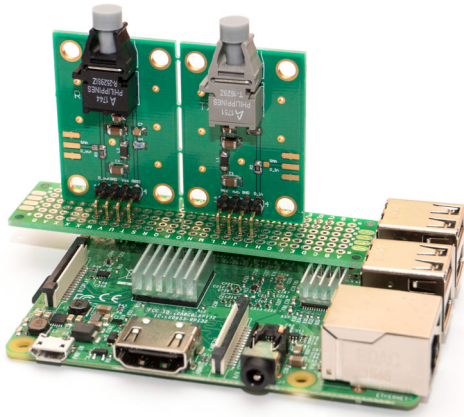
**Figure 2: AFBR-0553Z Connected to a Single-Board Computer**

Using unshielded single-wire strands or ribbon cables to connect the signal of the evaluation kit with other devices leads to signal interference. This can end in drastically reduced data transfer performance of the optical link. The data transmission quality decreases after only a few centimeters, as illustrated in [Figure 3](#). It is recommended to plug the 4-pin header of the evaluation kit directly into the pin sockets of devices (such as a single-board computer) without using wires. If longer distances are required, it is recommended to use the SMA interface and shielded SMA cables for Tx input and Rx output signals.

The evaluation kit was powered up and a 50 MBd PRBS data signal connected via 5 cm unshielded wire strands and fiber (the HFBR-RNS001Z) to establish an optical link at  $T_A = 25^\circ\text{C}$ . The following eye diagram of the electrical receiver data output signal ([Figure 3](#)) shows typical signal distortions by using unshielded wires for data transmission.

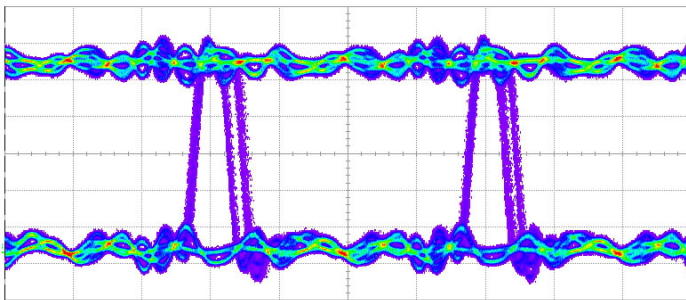
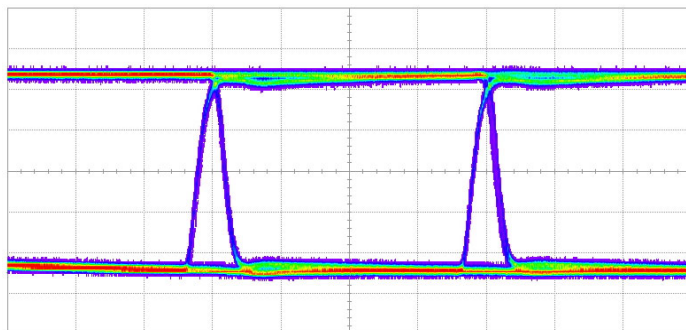
**Figure 3: Typical Eye Diagram of Distorted 50 MBd Receiver Output Signal when using 5 cm Long Unshielded Wires****Figure 4: Typical Eye Diagram of 50 MBd Receiver Output Signal when using SMA Signal Interface**

**NOTE:** Horizontal = 5 ns/div.

## PCB Modification for Signal Interface SMA

The basic evaluation board shown in [Figure 5](#) allows soldered SMA connectors (not included in the AFBR-0553Z) to the PCB for changing the signal path from a 4-pin header interface to an SMA signal interface by changing the position of resistors R2 and R3 (see [Figure 6](#) for placement).

If a waveform/pattern generator and/or oscilloscope are used for signal sourcing/monitoring or for link performance evaluation up to maximum specified data rates of 50 MBd, the usage of standard SMA measuring cables with 50Ω impedance is recommended to ensure noise-reduced operation conditions. The eye diagram of the electrical receiver data output signal (see [Figure 4](#)) shows the typical transmission quality at  $T_A = 25^\circ\text{C}$  when using the evaluation kit with SMA connectors and SMA signal lines.

The SMA connectors must be soldered to SMA PADS (ground pads are available on the TOP and BOTTOM layers) on the evaluation board and resistors R2 (Tx) and R3 (Rx) must be soldered from pin interface lines to SMA signal lines.

In case a low-impedance sink (such as an oscilloscope with 50Ω termination) is used for receiver output signal evaluation, load resistor R3 should be increased (for example, to 4.7 kΩ) to avoid overloading the receiver output stage.

**Figure 5: 4-Pin Interfaces (Delivery Condition)**

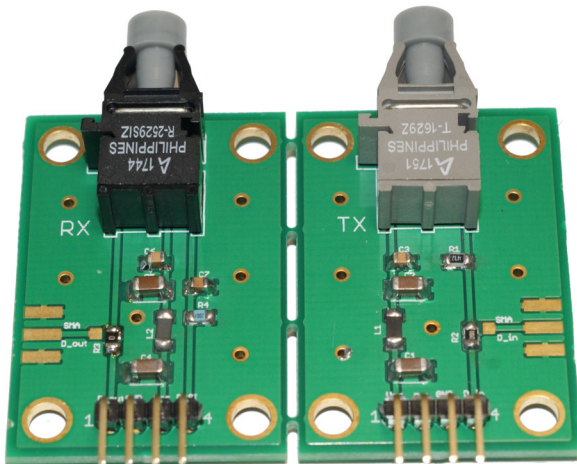

**Figure 6: Modified Interfaces with SMA Connectors for Tx Input and Rx Output Signals**

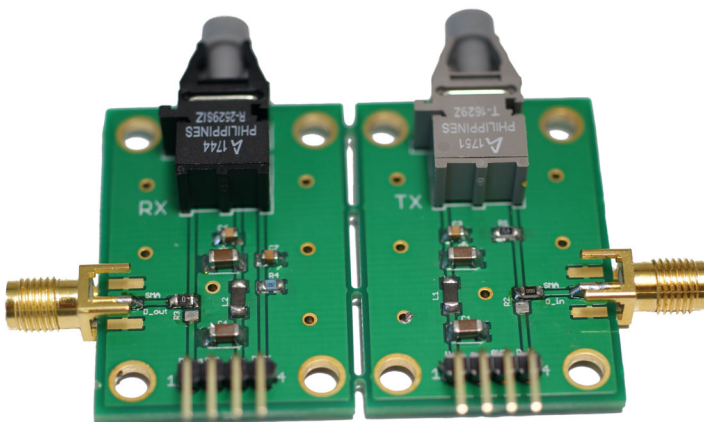

**NOTE:** The PCB can be broken into two sections by hand, if separation of receiver and transmitter is wished.

## Analog Monitoring Output

The Receiver Signal Strength Indicator (RSSI) is a monitoring output that delivers an output current proportional to the average incoming optical power. The integrating signal is directed to the RSSI output. To provide a suitable monitoring voltage across the shunt resistor,  $R_{RSSI}$ , its value should be chosen to suit the particular optical power situation of the specific application. The lower the optical receiver power, the higher the resistor value should be. Do not, however, override the maximum limit of  $V_{RSSI}$ .

The monitoring voltage varies linearly with the receiver optical input power. The variation over temperature is negligible for most applications. For an almost noise-free RSSI-signal, smoothing components are recommended. A capacitor,  $C_{RSSI}$ , in parallel to the resistor on the RSSI output reduces potential high-frequency signal parts. The use of a single 100 nF capacitor for signal smoothing is sufficient in most common applications.

AFBR-0533Z schematic:

- Shunt resistor,  $R_{RSSI} = R4$
- Capacitor,  $C_{RSSI} = C7$

If this RSSI function is not required, the output pin can be left floating.

The RSSI signal is derived from internal controlling loops, with the typical time constant of pure RSSI output current without an external filter can be up to 1 ms. This time constant also depends on the actual average incoming light power. The integrating (averaging) character of the RSSI output combined with the time constant results in a systemic conditioned fluctuation of the RSSI output signal at very low data rates and/or during data communications while showing relatively long time intervals where the optical input has constant HIGH or LOW. This should be considered in the application processing/polling of the RSSI output signal accordingly.

The RSSI output level depends on the LIP and the individual RSSI output responsivity (conversion rate) of each receiver under specific operating conditions. If more than incoming light indication is wished, a calibration by measuring the individual conversion rate of each receiver is recommended.

## RSSI Example Calculation

A typical value is assumed for RSSI Output Responsivity of 0.4 A/W ( $I_{RSSI}/P_{IN}$ ) when using plastic optical fiber (POF) and an average optical incoming light power ( $P_{IN}$ ) under operation and coupled into the receiver of  $-13$  dBm.

1.  $P_{IN}$  conversion (dBm to mW):

$$P(\text{mW}) = 10^{(P(\text{dBm})/10)} \rightarrow P_{IN} = -13 \text{ dBm (dBm} \rightarrow \text{mW)} \rightarrow P_{IN} \sim 0.05 \text{ mW}$$

2.  $I_{RSSI}$  calculation:

$$RSSI = 0.4 \text{ A/W} \rightarrow 0.4 \text{ mA/mW}; \rightarrow I_{RSSI} = (I_{RSSI}/P_{IN}) \times P_{IN} \rightarrow 0.4 \text{ mA/mW} \times 0.05 \text{ mW} \sim 0.02 \text{ mA}$$

At a  $P_{IN}$  of  $-13$  dBm (avg), the estimated current level provided by RSSI Output (pin 4) is around 0.02 mA (avg).

By using a 2 k $\Omega$  resistor in the RSSI Output path, the estimated voltage drop is 40 mV ( $0.02 \text{ mA} \times 2000\Omega$ ).

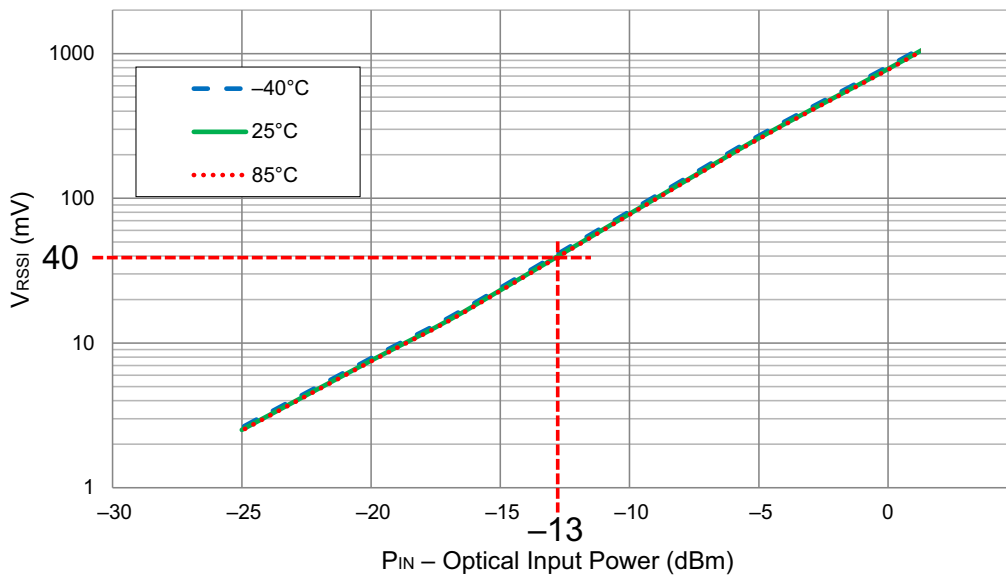
**Figure 7: Voltage Drop over 2 k $\Omega$  Resistor  $R_{RSSI}$  when Applying -13 dBm Optical Input Power**

The example calculation shows that the choice of resistor value at RSSI output is essential for an accurate evaluation of monitoring signals. The lower the voltage drop over  $R_{RSSI}$ , the worse the SNR of the monitoring signal in typical applications. Therefore, the lower the optical receiver power, the higher the resistor value should be. Do not, however, override the maximum limit of  $V_{RSSI}$ .

The recommended upper limit for the RSSI voltage drop is maximum  $V_{RSSI} (V_{CC} - 1V)$ . For 3.3V<sub>DC</sub> applications, this means 2.135V ( $3.3V \times 0.95 - 1V$ ) and for 5.0V<sub>DC</sub> operations, 3.75V ( $5.0V \times 0.95 - 1V$ ).

**Table 2: Installed Components on AFBR-0553Z Evaluation Kit**

Name	PCB Section	Description
RX	RX	AFBR-2529SIZ
TX	TX	AFBR-1629Z
C1	TX	10 $\mu$ F 10V 1206
C2	TX	10 $\mu$ F 10V 1206
C3	TX	100 nF 16V 0805
C4	RX	10 $\mu$ F 10V 1206
C5	RX	10 $\mu$ F 10V 1206
C6	RX	100 nF 16V 0805
C7	RX	100 nF 16V 0805
L1	TX	1 $\mu$ H 100 mA Ferrite Bead 1206
L2	RX	1 $\mu$ H 100 mA Ferrite Bead 1206
R1	TX	4.7 k $\Omega$ $\pm$ 10% 0805
R2	TX	0 $\Omega$ 0805
R3	RX	0 $\Omega$ 0805
R4	RX	2.0 k $\Omega$ $\pm$ 1% 0805

Broadcom, the pulse logo, Connecting everything, Avago Technologies, Avago, and the A logo are among the trademarks of Broadcom and/or its affiliates in the United States, certain other countries, and/or the EU.

Copyright © 2018 Broadcom. All Rights Reserved.

The term “Broadcom” refers to Broadcom Limited and/or its subsidiaries. For more information, please visit [www.broadcom.com](http://www.broadcom.com).

Broadcom reserves the right to make changes without further notice to any products or data herein to improve reliability, function, or design. Information furnished by Broadcom is believed to be accurate and reliable. However, Broadcom does not assume any liability arising out of the application or use of this information, nor the application or use of any product or circuit described herein, neither does it convey any license under its patent rights nor the rights of others.