

Fast Soft Recovery Rectifier Diode, 35 A

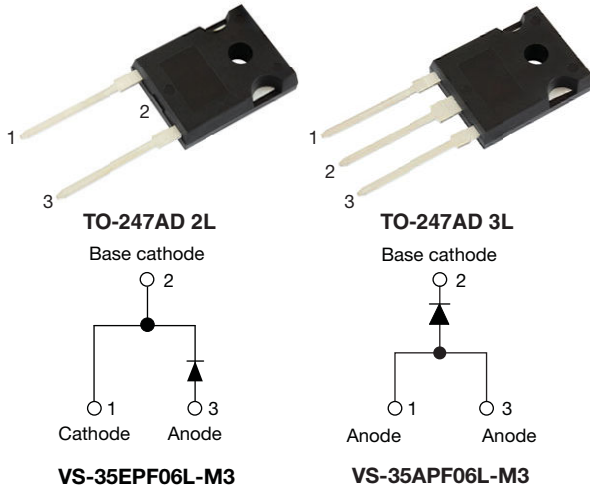

FEATURES

- Very low forward voltage drop and short reverse recovery time
- Glass passivated pellet chip junction
- Designed and qualified according to JEDEC® - JESD 47
- Flexible solution for reliable AC power rectification
- High surge, low V_F rugged blocking diode for DC charging stations
- AEC-Q101 qualified P/N available (VS-35EPF06LHM3, VS-35APF06LHM3)
- Material categorization: for definitions of compliance please see www.vishay.com/doc?99912



RoHS
COMPLIANT
HALOGEN
FREE

APPLICATIONS

These devices are intended for use in output rectification and freewheeling in inverters, choppers and converters as well as in input rectification where severe restrictions on conducted EMI should be met.

DESCRIPTION

The VS-35EPF06L-M3 and VS-30APF06L-M3 soft recovery rectifier series has been optimized for combined short reverse recovery time and low forward voltage drop.

The glass passivation ensures stable reliable operation in the most severe temperature and power cycling conditions.

PRIMARY CHARACTERISTICS	
$I_{F(AV)}$	35 A
V_R	600 V
V_F at I_F	1.27 V
I_{FSM}	320 A
t_{rr}	60 ns
T_J max.	150 °C
Snap factor	0.6
Package	TO-247AD 2L, TO-247AD 3L
Circuit configuration	Single

MAJOR RATINGS AND CHARACTERISTICS			
SYMBOL	CHARACTERISTICS	VALUES	UNITS
$I_{F(AV)}$	Sinusoidal waveform	35	A
V_{RRM}		600	V
I_{FSM}		320	A
V_F	15 A, $T_J = 25$ °C	1.27	V
t_{rr}	1 A, 100 A / μ s	60	ns
T_J		-40 to +150	°C

VOLTAGE RATINGS			
PART NUMBER	V_{RRM} , MAXIMUM PEAK REVERSE VOLTAGE V	V_{RSM} , MAXIMUM NON-REPETITIVE PEAK REVERSE VOLTAGE V	I_{RRM} AT 150 °C mA
VS-35EPF06L-M3	600	700	6
VS-35APF06L-M3	600	700	



ABSOLUTE MAXIMUM RATINGS				
PARAMETER	SYMBOL	TEST CONDITIONS	VALUES	UNITS
Maximum average forward current	$I_{F(AV)}$	$T_C = 103\text{ }^\circ\text{C}$, 180° conduction half sine wave	35	A
Maximum peak one cycle non-repetitive surge current	I_{FSM}	10 ms sine pulse, rated V_{RRM} applied	270	
		10 ms sine pulse, no voltage reapplied	320	
Maximum I^2t for fusing	I^2t	10 ms sine pulse, rated V_{RRM} applied	365	A^2s
		10 ms sine pulse, no voltage reapplied	515	
Maximum $I^2\sqrt{t}$ for fusing	$I^2\sqrt{t}$	$t = 0.1\text{ ms to }10\text{ ms}$, no voltage reapplied	5150	$A^2\sqrt{s}$

ELECTRICAL SPECIFICATIONS				
PARAMETER	SYMBOL	TEST CONDITIONS	VALUES	UNITS
Maximum forward voltage drop	V_{FM}	35 A, $T_J = 25\text{ }^\circ\text{C}$	1.46	V
Forward slope resistance	r_t	$T_J = 150\text{ }^\circ\text{C}$	12.5	$m\Omega$
Threshold voltage	$V_{F(TO)}$		0.90	V
Maximum reverse leakage current	I_{RM}	$T_J = 25\text{ }^\circ\text{C}$	0.1	mA
		$T_J = 150\text{ }^\circ\text{C}$	6	

RECOVERY CHARACTERISTICS				
PARAMETER	SYMBOL	TEST CONDITIONS	VALUES	UNITS
Reverse recovery time	t_{rr}	I_F at 20 A _{pk} 100 A/ μ s 25 °C	160	ns
Reverse recovery current	I_{rr}		10	A
Reverse recovery charge	Q_{rr}		1.25	μ C
Snap factor	S		Typical	0.6

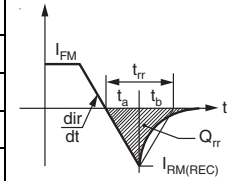

THERMAL - MECHANICAL SPECIFICATIONS				
PARAMETER	SYMBOL	TEST CONDITIONS	VALUES	UNITS
Maximum junction and storage temperature range	T_J, T_{Stg}		-40 to +150	$^\circ\text{C}$
Maximum thermal resistance, junction to case	R_{thJC}	DC operation	0.6	$^\circ\text{C/W}$
Maximum thermal resistance, junction to ambient	R_{thJA}		40	
Typical thermal resistance, case to heatsink	R_{thCS}	Mounting surface, smooth, and greased	0.25	
Approximate weight			6	g
			0.21	oz.
Mounting torque	minimum		6 (5)	$\text{kgf} \cdot \text{cm}$ $(\text{lb} \cdot \text{in})$
	maximum		12 (10)	
Marking device		Case style TO-247AD 2L	35EPF06L	
		Case style TO-247AD 3L	35APF06L	

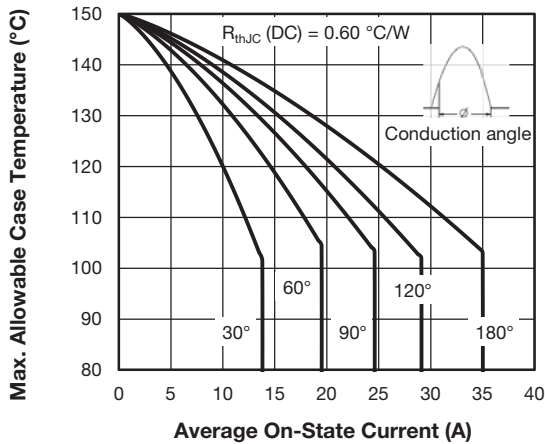

Fig. 1 - Current Rating Characteristics

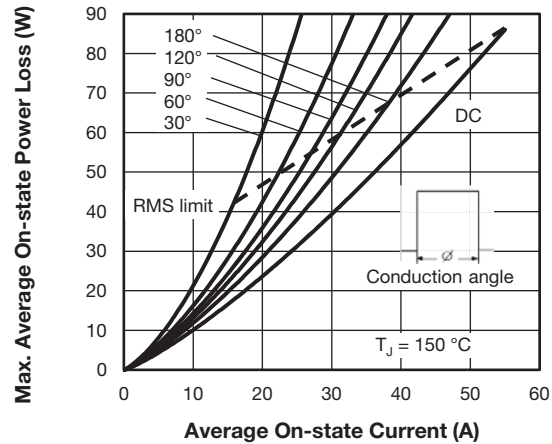

Fig. 4 - Forward Power Loss Characteristics

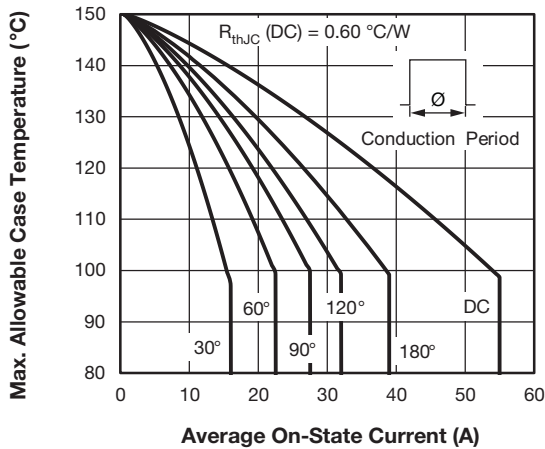

Fig. 2 - Current Rating Characteristics

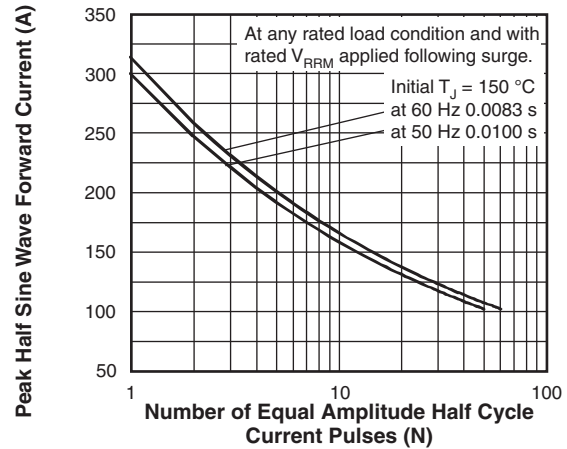

Fig. 5 - Maximum Non-Repetitive Surge Current

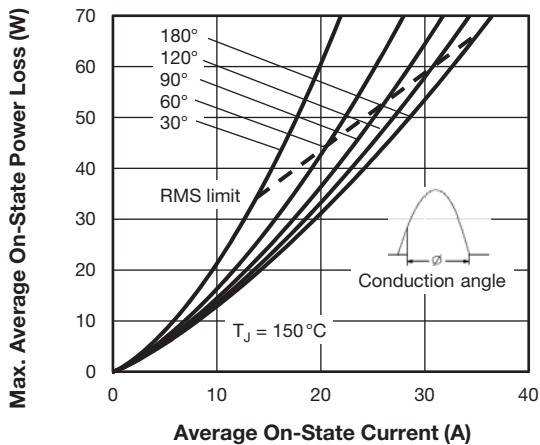

Fig. 3 - Forward Power Loss Characteristics

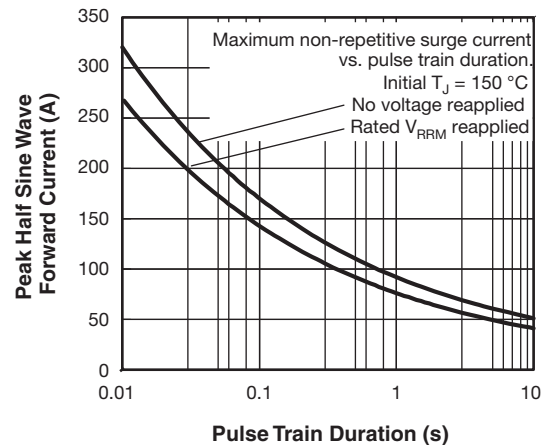

Fig. 6 - Maximum Non-Repetitive Surge Current

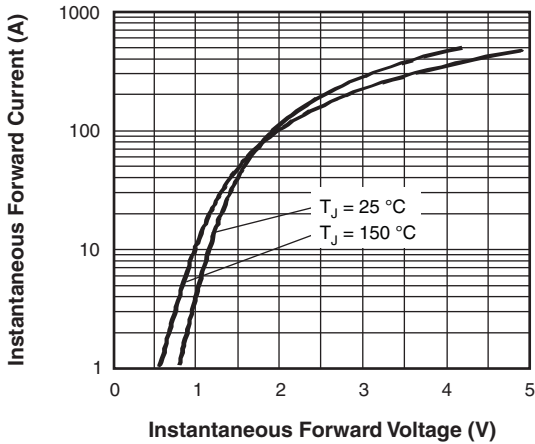

Fig. 7 - Forward Voltage Drop Characteristics

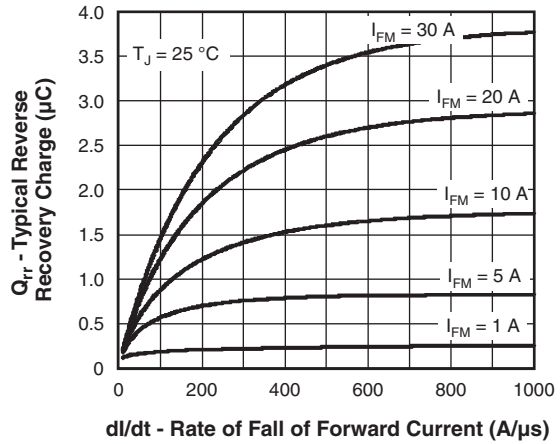

Fig. 10 - Recovery Charge Characteristics, T_J = 25 °C

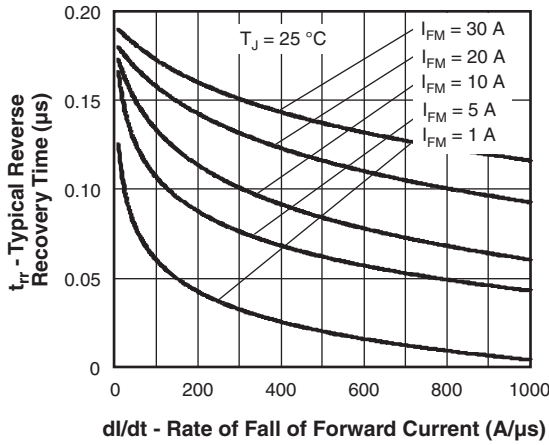

Fig. 8 - Thermal Impedance Z_{thJC} Characteristics

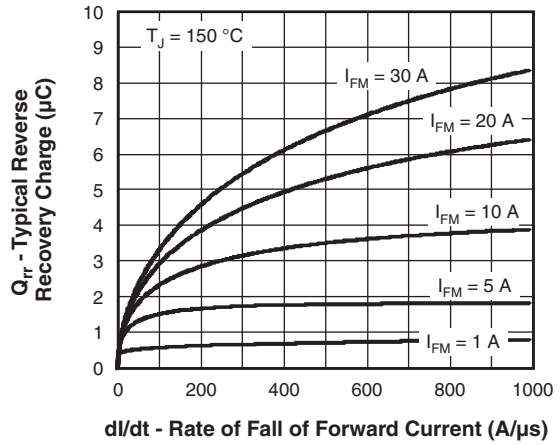

Fig. 11 - Recovery Charge Characteristics, T_J = 150 °C

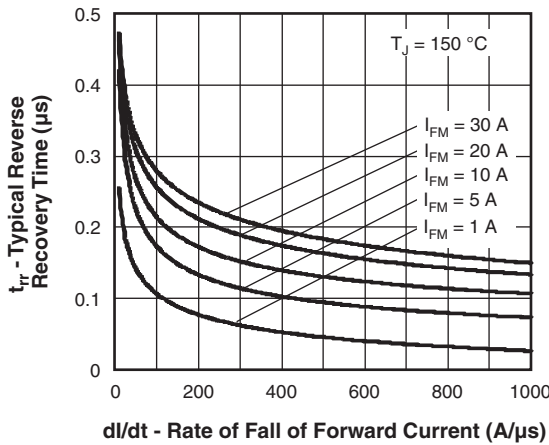

Fig. 9 - Recovery Time Characteristics, T_J = 150 °C

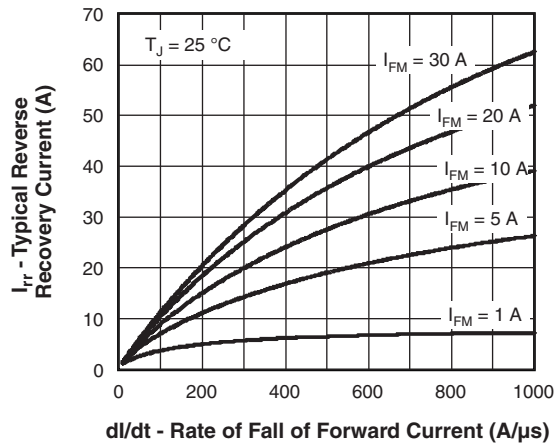

Fig. 12 - Recovery Current Characteristics, T_J = 25 °C

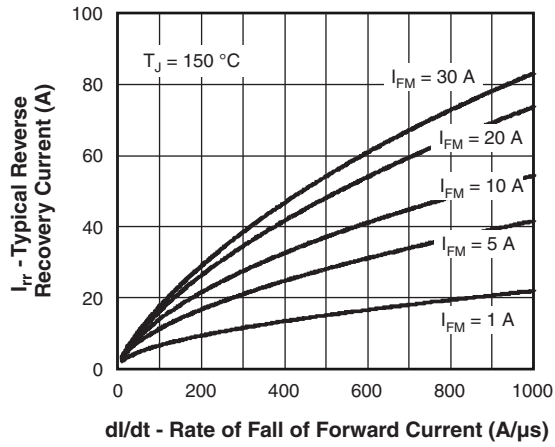

Fig. 13 - Recovery Current Characteristics, $T_J = 150\text{ }^\circ\text{C}$

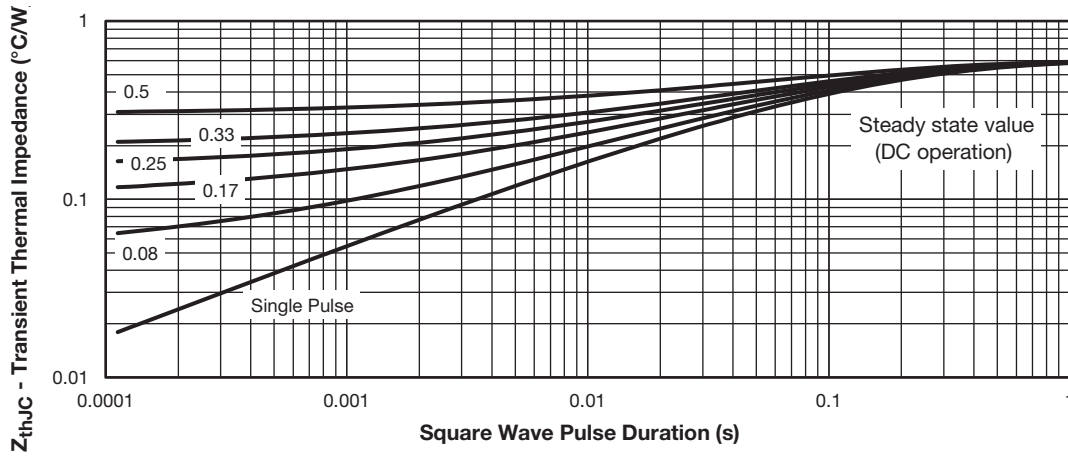
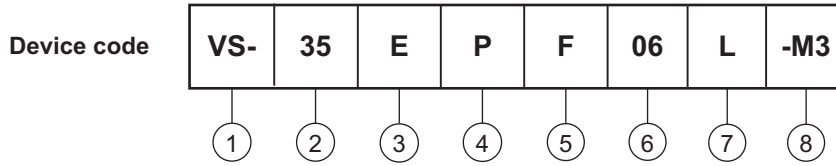

Fig. 14 - Thermal Impedance Z_{thJC} Characteristics



ORDERING INFORMATION TABLE



- 1** - Vishay Semiconductors product
- 2** - Current rating (35 = 35 A)
- 3** - Circuit configuration:
E = single, 2 pins
A = single, 3 pins
- 4** - Package:
P = TO-247AD
- 5** - Type of silicon:
F = fast recovery rectifier
- 6** - Voltage code x 100 = V_{RRM} ————— 06 = 600 V
- 7** - L = long leads
- 8** - Environmental digit:
-M3 = halogen-free, RoHS-compliant, and terminations lead (Pb)-free

ORDERING INFORMATION (Example)			
PREFERRED P/N	QUANTITY PER T/R	MINIMUM ORDER QUANTITY	PACKAGING DESCRIPTION
VS-35EPF06L-M3	25	500	Antistatic plastic tubes
VS-35APF06L-M3	25	500	Antistatic plastic tubes

LINKS TO RELATED DOCUMENTS		
Dimensions	TO-247AD 2L	www.vishay.com/doc?95536
	TO-247AD 3L	www.vishay.com/doc?95626
Part marking information	TO-247AD 2L	www.vishay.com/doc?95648
	TO-247AD 3L	www.vishay.com/doc?95007

TO-247AD 2L

DIMENSIONS in millimeters and inches



SYMBOL	MILLIMETERS		INCHES		NOTES	SYMBOL	MILLIMETERS		INCHES		NOTES
	MIN.	MAX.	MIN.	MAX.			MIN.	MAX.	MIN.	MAX.	
A	4.65	5.31	0.183	0.209		E	15.29	15.87	0.602	0.625	3
A1	2.21	2.59	0.087	0.102		E1	13.46	-	0.53	-	
A2	1.50	2.49	0.059	0.098		e	5.46 BSC		0.215 BSC		
b	0.99	1.40	0.039	0.055		Ø K	0.254		0.010		
b1	0.99	1.35	0.039	0.053		L	19.81	20.32	0.780	0.800	
b2	1.65	2.39	0.065	0.094		L1	3.71	4.29	0.146	0.169	
b3	1.65	2.34	0.065	0.092		Ø P	3.56	3.66	0.14	0.144	
c	0.38	0.89	0.015	0.035		Ø P1	-	6.98	-	0.275	
c1	0.38	0.84	0.015	0.033		Q	5.31	5.69	0.209	0.224	
D	19.71	20.70	0.776	0.815	3	R	4.52	5.49	0.178	0.216	
D1	13.08	-	0.515	-	4	S	5.51 BSC		0.217 BSC		
D2	0.51	1.35	0.020	0.053							

Notes

- (1) Dimensioning and tolerancing per ASME Y14.5M-1994
- (2) Contour of slot optional
- (3) Dimension D and E do not include mold flash. These dimensions are measured at the outermost extremes of the plastic body
- (4) Thermal pad contour optional with dimensions D1 and E1
- (5) Lead finish uncontrolled in L1
- (6) Ø P to have a maximum draft angle of 1.5 to the top of the part with a maximum hole diameter of 3.91 mm (0.154")
- (7) Outline conforms to JEDEC® outline TO-247 with exception of dimension A min., D, E min., Q min., S, and note 4

TO-247AD 3L

DIMENSIONS in millimeters and inches

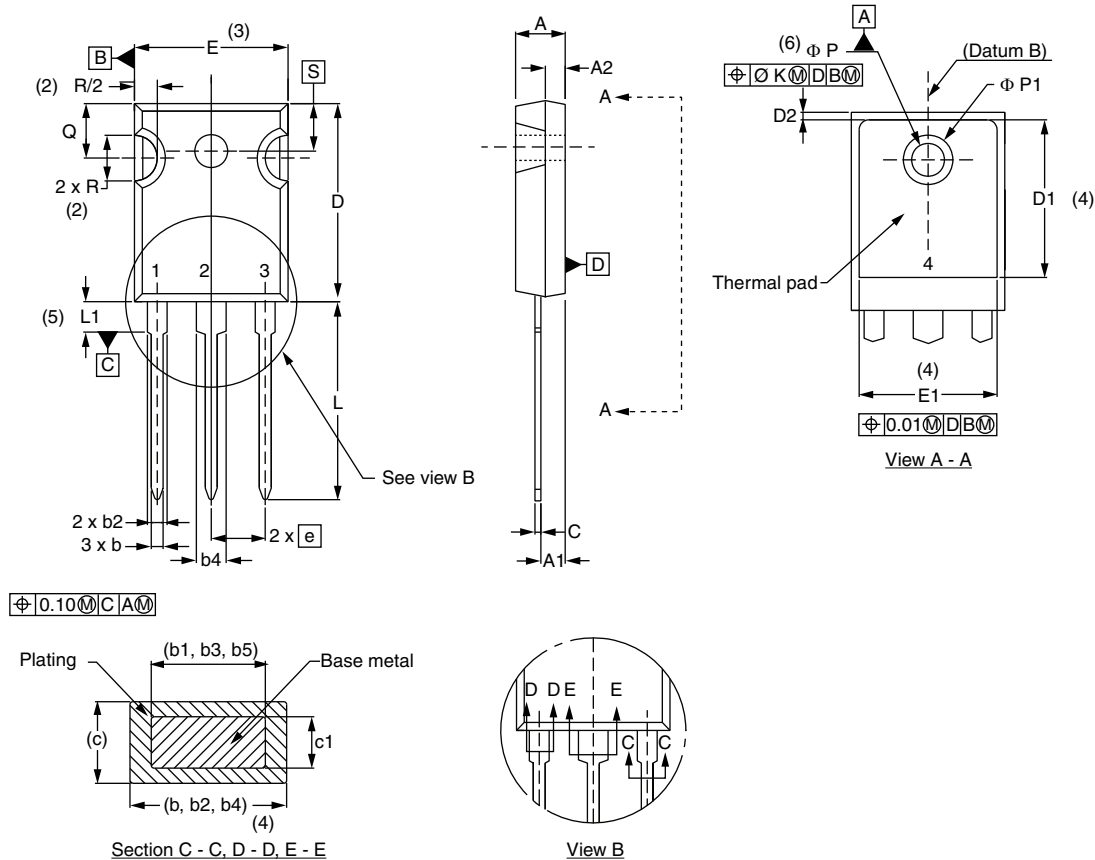

SYMBOL	MILLIMETERS		INCHES		NOTES	SYMBOL	MILLIMETERS		INCHES		NOTES
	MIN.	MAX.	MIN.	MAX.			MIN.	MAX.	MIN.	MAX.	
A	4.65	5.31	0.183	0.209		D2	0.51	1.30	0.020	0.051	
A1	2.21	2.59	0.087	0.102		E	15.29	15.87	0.602	0.625	3
A2	1.50	2.49	0.059	0.098		E1	13.46	-	0.53	-	
b	0.99	1.40	0.039	0.055		e	5.46 BSC		0.215 BSC		
b1	0.99	1.35	0.039	0.053		Ø K	0.254		0.010		
b2	1.65	2.39	0.065	0.094		L	19.81	20.32	0.780	0.800	
b3	1.65	2.34	0.065	0.092		L1	3.71	4.29	0.146	0.169	
b4	2.59	3.43	0.102	0.135		Ø P	3.56	3.66	0.14	0.144	
b5	2.59	3.38	0.102	0.133		Ø P1	-	6.98	-	0.275	
c	0.38	0.89	0.015	0.035		Q	5.31	5.69	0.209	0.224	
c1	0.38	0.84	0.015	0.033		R	4.52	5.49	0.178	0.216	
D	19.71	20.70	0.776	0.815	3	S	5.51 BSC		0.217 BSC		
D1	13.08	-	0.515	-	4						

Notes

- (1) Dimensioning and tolerancing per ASME Y14.5M-1994
- (2) Contour of slot optional
- (3) Dimension D and E do not include mold flash. These dimensions are measured at the outermost extremes of the plastic body
- (4) Thermal pad contour optional with dimensions D1 and E1
- (5) Lead finish uncontrolled in L1
- (6) Ø P to have a maximum draft angle of 1.5 to the top of the part with a maximum hole diameter of 3.91 mm (0.154")
- (7) Outline conforms to JEDEC® outline TO-247 with exception of dimension A min., D, E min., Q min., S, and note 4



Disclaimer

ALL PRODUCT, PRODUCT SPECIFICATIONS AND DATA ARE SUBJECT TO CHANGE WITHOUT NOTICE TO IMPROVE RELIABILITY, FUNCTION OR DESIGN OR OTHERWISE.

Vishay Intertechnology, Inc., its affiliates, agents, and employees, and all persons acting on its or their behalf (collectively, "Vishay"), disclaim any and all liability for any errors, inaccuracies or incompleteness contained in any datasheet or in any other disclosure relating to any product.

Vishay makes no warranty, representation or guarantee regarding the suitability of the products for any particular purpose or the continuing production of any product. To the maximum extent permitted by applicable law, Vishay disclaims (i) any and all liability arising out of the application or use of any product, (ii) any and all liability, including without limitation special, consequential or incidental damages, and (iii) any and all implied warranties, including warranties of fitness for particular purpose, non-infringement and merchantability.

Statements regarding the suitability of products for certain types of applications are based on Vishay's knowledge of typical requirements that are often placed on Vishay products in generic applications. Such statements are not binding statements about the suitability of products for a particular application. It is the customer's responsibility to validate that a particular product with the properties described in the product specification is suitable for use in a particular application. Parameters provided in datasheets and / or specifications may vary in different applications and performance may vary over time. All operating parameters, including typical parameters, must be validated for each customer application by the customer's technical experts. Product specifications do not expand or otherwise modify Vishay's terms and conditions of purchase, including but not limited to the warranty expressed therein.

Hyperlinks included in this datasheet may direct users to third-party websites. These links are provided as a convenience and for informational purposes only. Inclusion of these hyperlinks does not constitute an endorsement or an approval by Vishay of any of the products, services or opinions of the corporation, organization or individual associated with the third-party website. Vishay disclaims any and all liability and bears no responsibility for the accuracy, legality or content of the third-party website or for that of subsequent links.

Except as expressly indicated in writing, Vishay products are not designed for use in medical, life-saving, or life-sustaining applications or for any other application in which the failure of the Vishay product could result in personal injury or death. Customers using or selling Vishay products not expressly indicated for use in such applications do so at their own risk. Please contact authorized Vishay personnel to obtain written terms and conditions regarding products designed for such applications.

No license, express or implied, by estoppel or otherwise, to any intellectual property rights is granted by this document or by any conduct of Vishay. Product names and markings noted herein may be trademarks of their respective owners.