

SUMMARY



Image is for illustrative purpose only

Wires

Low voltage 6

Series	OK
Termination type	Female solder
IP rating	68
AWG wire size	34.00 - 28.00
Cable Ø	0.00 - 0.00 mm
Status	active
Matching parts	FGG.0K.306.KLAC40Z

Download

[Request a quote](#)

[Catalog](#)

TECHNICAL DETAILS

Mechanics

Shell Style/Model	EE*: Fixed receptacle, nut fixing (back panel mounting)
Keying	1 key (alpha=0, plug: male contacts, receptacle: female contacts)
Housing Material	Brass (black chrome) shell and collet nut, nickel plated [SAE AMS QQ N 290] brass latch sleeve and mid pieces
Weight	12.28 g

Performance

Configuration	OK.306 : 6 Low Voltage
Insulator	L: PEEK (UL 94 / V-0/1.5)
Rated Current	2.5 Amps

Specifications

Contact Type:	Solder
Contact Dia.:	0.5 mm (0.02in)
Bucket Dia.:	0.45 mm (0.018in)
Max. Solid Conductor:	0.09 mm ² (AWG 28)
Max. Stranded Conductor:	0.09 mm ² (AWG 28)
R (max):	8.7 mOhm
Vtest (contact-shell):	650 V (AC), 920 V (DC)
Vtest (contact-contact):	850 V (AC), 1200 V (DC)

LEMO products and services are provided "as is". LEMO makes no warranties or representations with regard to LEMO product & services or use of them, express, implied or statutory, including for accuracy, completeness, or security. The user is fully responsible for his products and applications using LEMO components.

Others

Endurance (Shell): 5000 mating cycles
 Temp (min / max): -55°C / +200°C
 Humidity (max): <=95% [at 60 deg C / 140 F]
 Vibration: 15 g [10 Hz - 2000 Hz]
 Shock Resistance: 100 g [6 ms]
 Climatical Category: 50/175/21
 Shielding (min): 95 dB (10 MHz)
 Shielding (min): 80 dB (1 GHz)
 Salt Spray Corrosion: >1000 hr

DRAWINGS

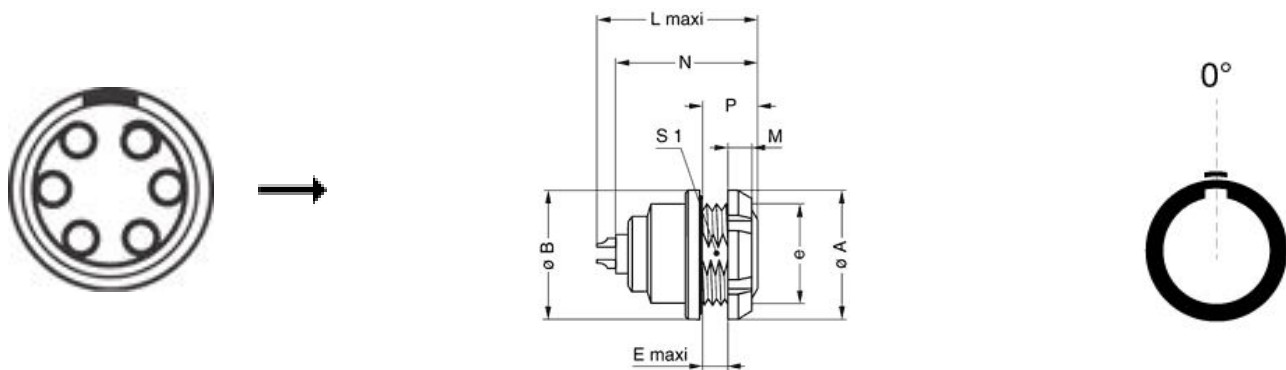

Dimensions







	A	B	E	L	M	N	P	S1	e
mm.	18	18	3.4	21.7	3.5	20.1	7	12.5	M14x1.0
in.	0,71	0,71	0,13	0,85	0,14	0,79	0,28	0,49	

RECOMMENDED BY LEMO

Tools

LEMO products and services are provided "as is". LEMO makes no warranties or representations with regard to LEMO product & services or use of them, express, implied or statutory, including for accuracy, completeness, or security. The user is fully responsible for his products and applications using LEMO components.

Cables

CMN.06.T28.031PGCE	PVC	GREY	
CMN.06.T28.031PGZE		Grey	
CMN.06.T28.031PNCE	PVC	Black	
CMN.06.T28.031PNZE			
CMN.06.T28.042QBCE	TPR (medical)		
CMN.06.T28.044PGZE		Grey	
CMN.06.T28.044PNZE			
12080	PVC	Grey	
6280	PVC	Black	

LEMO products and services are provided "as is". LEMO makes no warranties or representations with regard to LEMO product & services or use of them, express, implied or statutory, including for accuracy, completeness, or security. The user is fully responsible for his products and applications using LEMO components.