

# NLX2G32

## Dual 2-Input OR Gate

The NLX2G32 is a high performance dual 2-input OR Gate operating from a 1.65 V to 5.5 V supply.

### Features

- Extremely High Speed:  $t_{PD}$  2.5 ns (typical) at  $V_{CC} = 5$  V
- Designed for 1.65 V to 5.5 V  $V_{CC}$  Operation
- Over Voltage Tolerant Inputs
- LVTTL Compatible – Interface Capability With 5 V TTL Logic with  $V_{CC} = 3$  V
- LVC MOS Compatible
- 24 mA Balanced Output Sink and Source Capability
- Near Zero Static Supply Current Substantially Reduces System Power Requirements
- Replacement for NC7WZ32
- Chip Complexity: FET = 120
- These are Pb-Free Devices

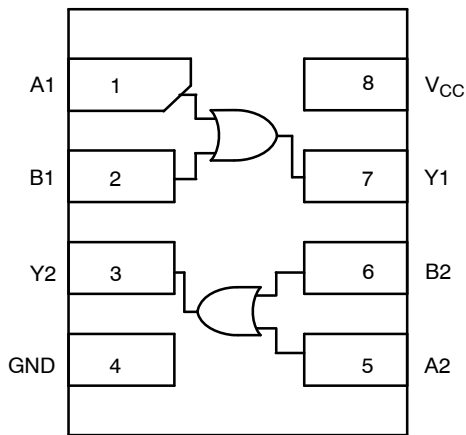

Figure 1. Pinout

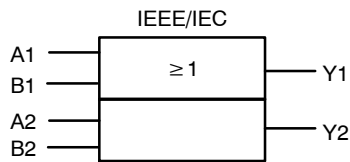

Figure 2. Logic Symbol

### PIN ASSIGNMENT

Pin	Function
1	A1
2	B1
3	Y2
4	GND
5	A2
6	B2
7	Y1
8	$V_{CC}$

### FUNCTION TABLE

Input		Output $Y = A + B$
A	B	Y
L	L	L
L	H	H
H	L	H
H	H	H



ON Semiconductor®

<http://onsemi.com>

### MARKING DIAGRAMS



ULLGA8  
1.45 x 1.0  
CASE 613AA

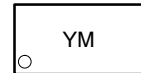

ULLGA8  
1.6 x 1.0  
CASE 613AB

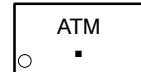

ULLGA8  
1.95 x 1.0  
CASE 613AC



UDFN8  
1.45 x 1.0  
CASE 517BZ

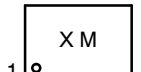

UDFN8  
1.6 x 1.0  
CASE 517BY

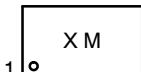

UDFN8  
1.95 x 1.0  
CASE 517CA

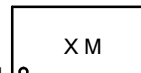

- XX = Specific Device Code
- M = Date Code
- = Pb-Free Package

### ORDERING INFORMATION

See detailed ordering and shipping information in the package dimensions section on page 4 of this data sheet.

# NLX2G32

## MAXIMUM RATINGS

Symbol	Parameter	Value	Unit
V <sub>CC</sub>	DC Supply Voltage	- 0.5 to + 7.0	V
V <sub>I</sub>	DC Input Voltage	- 0.5 to + 7.0	V
V <sub>O</sub>	DC Output Voltage	- 0.5 to + 7.0	V
I <sub>IK</sub>	DC Input Diode Current V <sub>I</sub> < GND	- 50	mA
I <sub>OK</sub>	DC Output Diode Current V <sub>O</sub> < GND	- 50	mA
I <sub>O</sub>	DC Output Sink Current	± 50	mA
I <sub>CC</sub>	DC Supply Current per Supply Pin	± 100	mA
I <sub>GND</sub>	DC Ground Current per Ground Pin	± 100	mA
T <sub>STG</sub>	Storage Temperature Range	- 65 to + 150	°C
T <sub>L</sub>	Lead Temperature, 1 mm from Case for 10 Seconds	260	°C
T <sub>J</sub>	Junction Temperature under Bias	+ 150	°C
θ <sub>JA</sub>	Thermal Resistance (Note 1)	250	°C/W
P <sub>D</sub>	Power Dissipation in Still Air at 85°C	250	mW
MSL	Moisture Sensitivity	Level 1	
F <sub>R</sub>	Flammability Rating Oxygen Index: 28 to 34	UL 94 V-0 @ 0.125 in	
V <sub>ESD</sub>	ESD Withstand Voltage Human Body Model (Note 2) Machine Model (Note 3) Charged Device Model (Note 4)	> 2000 > 200 N/A	V
I <sub>Latch-Up</sub>	Latch-Up Performance Above V <sub>CC</sub> and Below GND at 85°C (Note 5)	± 500	mA

Stresses exceeding Maximum Ratings may damage the device. Maximum Ratings are stress ratings only. Functional operation above the Recommended Operating Conditions is not implied. Extended exposure to stresses above the Recommended Operating Conditions may affect device reliability.

1. Measured with minimum pad spacing on an FR4 board, using 10 mm-by-1 inch, 2-ounce copper trace with no air flow.
2. Tested to EIA/JESD22-A114-A.
3. Tested to EIA/JESD22-A115-A.
4. Tested to JESD22-C101-A.
5. Tested to EIA/JESD78.

## RECOMMENDED OPERATING CONDITIONS

Symbol	Parameter	Min	Max	Unit
V <sub>CC</sub>	Supply Voltage Operating Data Retention Only	1.65 1.5	5.5 5.5	V
V <sub>I</sub>	Input Voltage (Note 6)	0	5.5	V
V <sub>O</sub>	Output Voltage (HIGH or LOW State)	0	V <sub>CC</sub>	V
T <sub>A</sub>	Operating Free-Air Temperature	- 40	+ 85	°C
Δt/ΔV	Input Transition Rise or Fall Rate V <sub>CC</sub> = 1.8 V ± 0.15 V V <sub>CC</sub> = 2.5 V ± 0.2 V V <sub>CC</sub> = 3.0 V ± 0.3 V V <sub>CC</sub> = 5.0 V ± 0.5 V	0 0 0 0	20 20 10 5	ns/V

6. Unused inputs may not be left open. All inputs must be tied to a high-logic voltage level or a low-logic input voltage level.

# NLX2G32

## DC ELECTRICAL CHARACTERISTICS

Symbol	Parameter	Condition	V <sub>CC</sub> (V)	T <sub>A</sub> = +25°C			T <sub>A</sub> = -40°C to +85°C		Unit
				Min	Typ	Max	Min	Max	
V <sub>IH</sub>	HIGH Level Input Voltage		1.65 to 1.95	0.75 V <sub>CC</sub> 0.7 V <sub>CC</sub>			0.75 V <sub>CC</sub> 0.7 V <sub>CC</sub>		V
V <sub>IL</sub>	LOW Level Input Voltage		1.65 to 1.95 2.3 to 5.5			0.3 V <sub>CC</sub>		0.3 V <sub>CC</sub>	V
V <sub>OH</sub>	HIGH Level Output Voltage V <sub>IN</sub> = V <sub>IH</sub>	I <sub>OH</sub> = -100 μA	1.65	1.55	1.65		1.55		V
			2.3	2.2	2.3		2.2		
			3.0	2.9	3.0		2.9		
			4.5	4.4	4.5		4.4		
		I <sub>OH</sub> = -4 mA I <sub>OH</sub> = -8 mA I <sub>OH</sub> = -16 mA I <sub>OH</sub> = -24 mA I <sub>OH</sub> = -32 mA	1.65	1.29	1.52		1.20		
			2.3	1.9	2.15		1.9		
V <sub>OL</sub>	Low-Level Output Voltage V <sub>IN</sub> = V <sub>IL</sub>	I <sub>OL</sub> = 100 μA	1.65		0	0.1			V
			2.3		0	0.1			
			3.0		0	0.1			
			4.5		0	0.1			
			I <sub>OH</sub> = 4 mA I <sub>OH</sub> = 8 mA I <sub>OH</sub> = 16 mA I <sub>OH</sub> = 24 mA I <sub>OH</sub> = 32 mA	1.65		0.08	0.24		
2.3		0.1	0.3						
3.0		0.15	0.4						
4.5		0.22	0.55						
I <sub>IN</sub>	Input Leakage Current	V <sub>IN</sub> = V <sub>CC</sub> or GND	0 to 5.5			±0.1		±1.0	μA
I <sub>OFF</sub>	Power OFF Leakage Current	V <sub>IN</sub> or V <sub>OUT</sub> = 5.5 V	0.0			1.0		10	
I <sub>CC</sub>	Quiescent Supply Current	V <sub>IN</sub> = V <sub>CC</sub> or GND	5.5			1.0		10	μA

## AC ELECTRICAL CHARACTERISTICS t<sub>R</sub> = t<sub>F</sub> = 3.0 ns

Symbol	Parameter	Condition	V <sub>CC</sub> (V)	T <sub>A</sub> = 25°C			-40°C ≤ T <sub>A</sub> ≤ 85°C		Unit
				Min	Typ	Max	Min	Max	
t <sub>PLH</sub>	Propagation Delay (Figure 3 and 4)	R <sub>L</sub> = 1 MΩ, C <sub>L</sub> = 15 pF	1.8 ± 0.15	2.0	8.0	9.5	2.0	10.5	ns
			2.5 ± 0.2	1.0	3.5	5.8	1.0	6.2	
t <sub>PHL</sub>		R <sub>L</sub> = 1 MΩ, C <sub>L</sub> = 15 pF	3.3 ± 0.3	0.8	2.6	3.9	0.8	4.3	
		R <sub>L</sub> = 500 Ω, C <sub>L</sub> = 50 pF		1.2	3.2	4.8	1.2	5.2	
		R <sub>L</sub> = 1 MΩ, C <sub>L</sub> = 15 pF	5.0 ± 0.5	0.5	1.9	3.1	0.5	3.3	
		R <sub>L</sub> = 500 Ω, C <sub>L</sub> = 50 pF		0.8	2.5	3.7	0.8	4.0	

## CAPACITIVE CHARACTERISTICS

Symbol	Parameter	Condition	Typical	Unit
C <sub>IN</sub>	Input Capacitance	V <sub>CC</sub> = 5.5 V, V <sub>I</sub> = 0 V or V <sub>CC</sub>	2.5	pF
C <sub>PD</sub>	Power Dissipation Capacitance (Note 7)	10 MHz, V <sub>CC</sub> = 3.3 V, V <sub>I</sub> = 0 V or V <sub>CC</sub>	9	pF
		10 MHz, V <sub>CC</sub> = 5.5 V, V <sub>I</sub> = 0 V or V <sub>CC</sub>	11	

7. C<sub>PD</sub> is defined as the value of the internal equivalent capacitance which is calculated from the operating current consumption without load. Average operating current can be obtained by the equation: I<sub>CC(OPR)</sub> = C<sub>PD</sub> • V<sub>CC</sub> • f<sub>in</sub> + I<sub>CC</sub>. C<sub>PD</sub> is used to determine the no-load dynamic power consumption; P<sub>D</sub> = C<sub>PD</sub> • V<sub>CC</sub><sup>2</sup> • f<sub>in</sub> + I<sub>CC</sub> • V<sub>CC</sub>.

## NLX2G32

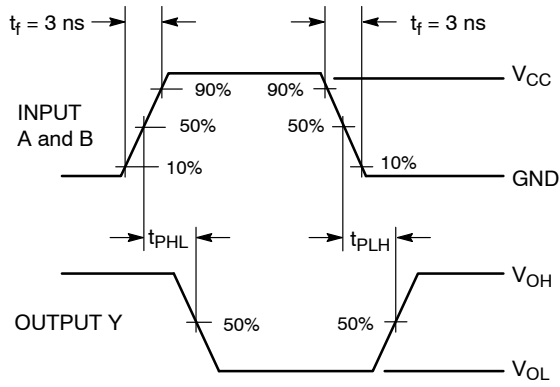
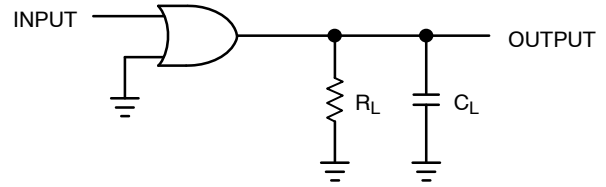

Figure 3. Switching Waveform



A 1-MHz square input wave is recommended for propagation delay tests.

Figure 4. Test Circuit

### DEVICE ORDERING INFORMATION

Device Order Number	Package Type	Tape and Reel Size <sup>†</sup>
NLX2G32AMX1TCG	ULLGA, 1.95x1 (Pb-Free)	178 mm, 3000 Units / Tape & Reel
NLX2G32BMX1TCG	ULLGA, 1.6x1 (Pb-Free)	178 mm, 3000 Units / Tape & Reel
NLX2G32CMX1TCG	ULLGA, 1.45x1 (Pb-Free)	178 mm, 3000 Units / Tape & Reel
NLX2G32DMUTCG	UDFN8, 1.95 x 1.0, 0.5P (Pb-Free)	3000 Units / Tape & Reel
NLX2G32EMUTCG	UDFN8, 1.6 x 1.0, 0.4P (Pb-Free)	3000 Units / Tape & Reel
NLX2G32FMUTCG	UDFN8, 1.45 x 1.0, 0.35P (Pb-Free)	3000 Units / Tape & Reel

<sup>†</sup>For information on tape and reel specifications, including part orientation and tape sizes, please refer to our Tape and Reel Packaging Specifications Brochure, BRD8011/D.

# NLX2G32

## PACKAGE DIMENSIONS

UDFN8 1.6x1.0, 0.4P  
CASE 517BY  
ISSUE O

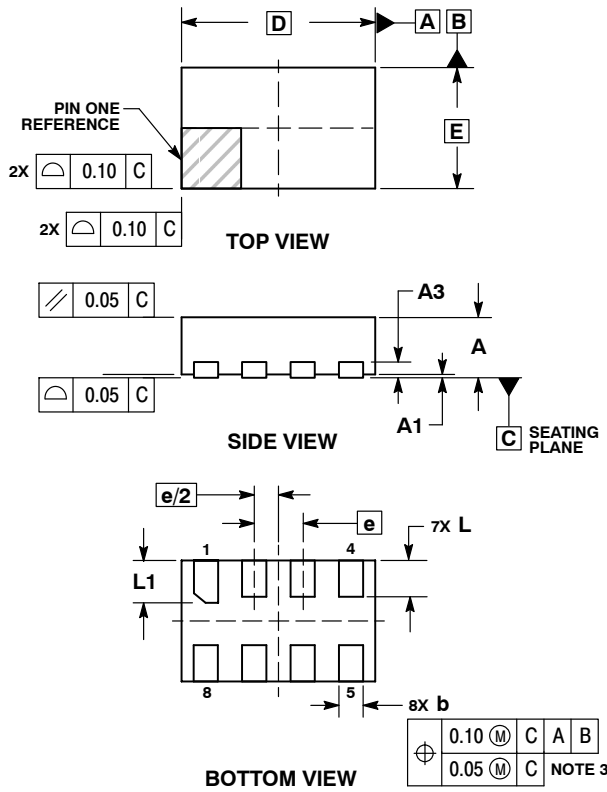

- NOTES:
1. DIMENSIONING AND TOLERANCING PER ASME Y14.5M, 1994.
  2. CONTROLLING DIMENSION: MILLIMETERS.
  3. DIMENSION b APPLIES TO PLATED TERMINAL AND IS MEASURED BETWEEN 0.15 AND 0.20 MM FROM TERMINAL TIP.
  4. PACKAGE DIMENSIONS EXCLUSIVE OF BURRS AND MOLD FLASH.

DIM	MILLIMETERS	
	MIN	MAX
A	0.45	0.55
A1	0.00	0.05
A3	0.13	REF
b	0.15	0.25
D	1.60	BSC
E	1.00	BSC
e	0.40	BSC
L	0.25	0.35
L1	0.30	0.40

### RECOMMENDED SOLDERING FOOTPRINT\*

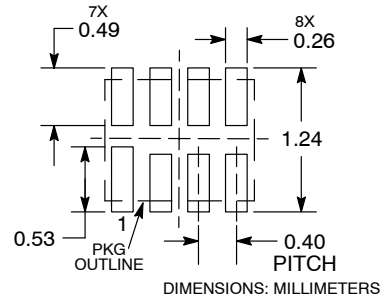

\*For additional information on our Pb-Free strategy and soldering details, please download the ON Semiconductor Soldering and Mounting Techniques Reference Manual, SOLDERRM/D.

# NLX2G32

## PACKAGE DIMENSIONS

UDFN8 1.45x1.0, 0.35P  
CASE 517BZ  
ISSUE O

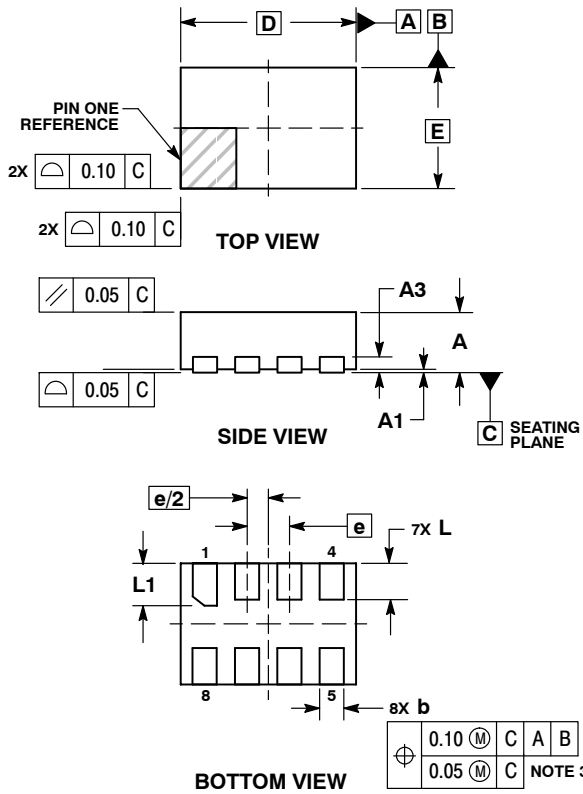

**NOTES:**

1. DIMENSIONING AND TOLERANCING PER ASME Y14.5M, 1994.
2. CONTROLLING DIMENSION: MILLIMETERS.
3. DIMENSION b APPLIES TO PLATED TERMINAL AND IS MEASURED BETWEEN 0.15 AND 0.20 MM FROM TERMINAL TIP.
4. PACKAGE DIMENSIONS EXCLUSIVE OF BURRS AND MOLD FLASH.

DIM	MILLIMETERS	
	MIN	MAX
A	0.45	0.55
A1	0.00	0.05
A3	0.13 REF	
b	0.15	0.25
D	1.45 BSC	
E	1.00 BSC	
e	0.35 BSC	
L	0.25	0.35
L1	0.30	0.40

### RECOMMENDED SOLDERING FOOTPRINT\*

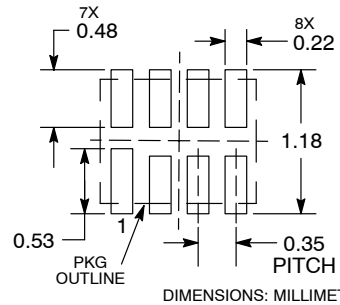

\*For additional information on our Pb-Free strategy and soldering details, please download the ON Semiconductor Soldering and Mounting Techniques Reference Manual, SOLDERRM/D.

# NLX2G32

## PACKAGE DIMENSIONS

UDFN8 1.95x1.0, 0.5P  
CASE 517CA  
ISSUE O

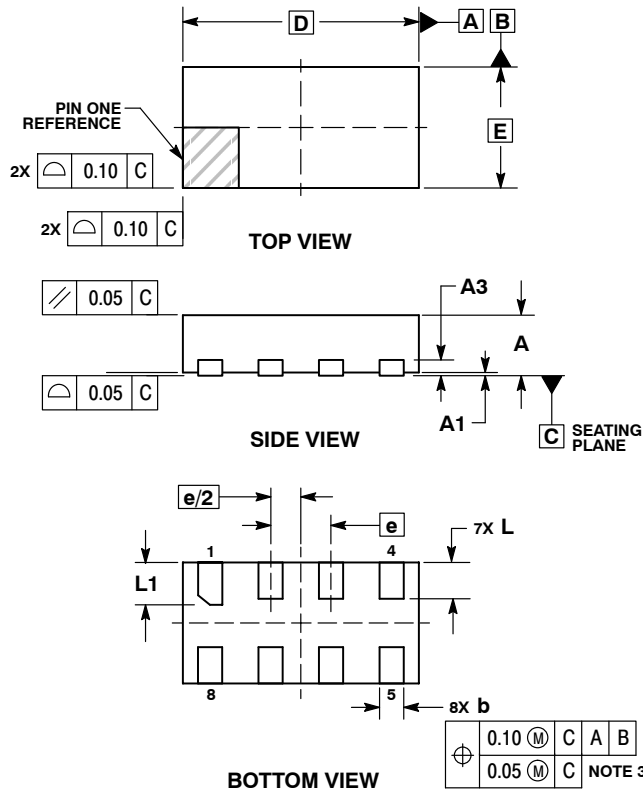

**NOTES:**

1. DIMENSIONING AND TOLERANCING PER ASME Y14.5M, 1994.
2. CONTROLLING DIMENSION: MILLIMETERS.
3. DIMENSION b APPLIES TO PLATED TERMINAL AND IS MEASURED BETWEEN 0.15 AND 0.20 MM FROM TERMINAL TIP.
4. PACKAGE DIMENSIONS EXCLUSIVE OF BURRS AND MOLD FLASH.

MILLIMETERS		
DIM	MIN	MAX
A	0.45	0.55
A1	0.00	0.05
A3	0.13 REF	
b	0.15	0.25
D	1.95 BSC	
E	1.00 BSC	
e	0.50 BSC	
L	0.25	0.35
L1	0.30	0.40

**RECOMMENDED SOLDERING FOOTPRINT\***

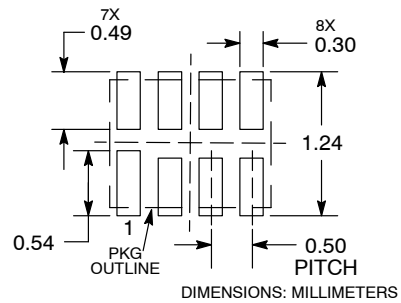

\*For additional information on our Pb-Free strategy and soldering details, please download the ON Semiconductor Soldering and Mounting Techniques Reference Manual, SOLDERRM/D.

# NLX2G32

## PACKAGE DIMENSIONS

ULLGA8 1.45x1.0, 0.35P  
CASE 613AA  
ISSUE A

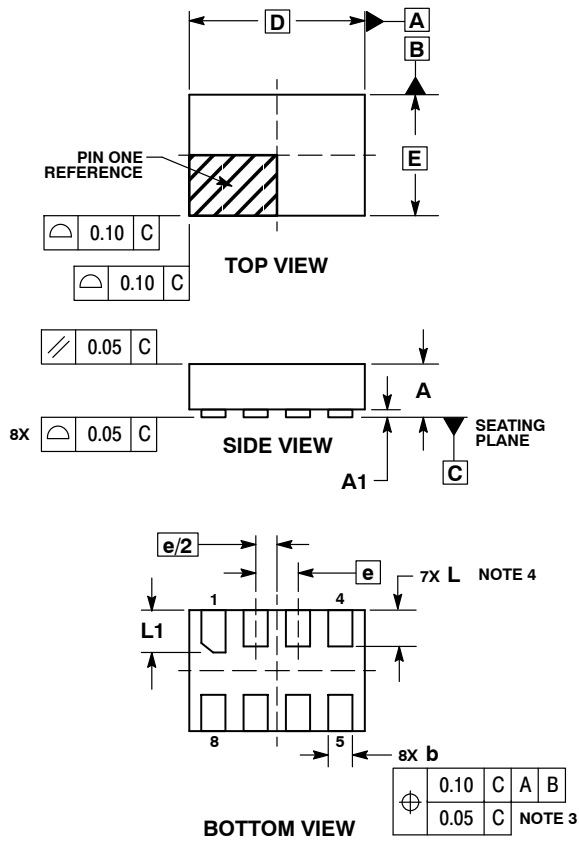

**NOTES:**

1. DIMENSIONING AND TOLERANCING PER ASME Y14.5M, 1994.
2. CONTROLLING DIMENSION: MILLIMETERS.
3. DIMENSION b APPLIES TO PLATED TERMINAL AND IS MEASURED BETWEEN 0.15 AND 0.30 mm FROM THE TERMINAL TIP.
4. A MAXIMUM OF 0.05 PULL BACK OF THE PLATED TERMINAL FROM THE EDGE OF THE PACKAGE IS ALLOWED.

DIM	MILLIMETERS	
	MIN	MAX
A	---	0.40
A1	0.00	0.05
b	0.15	0.25
D	1.45 BSC	
E	1.00 BSC	
e	0.35 BSC	
L	0.25	0.35
L1	0.30	0.40

**MOUNTING FOOTPRINT  
SOLDERMASK DEFINED\***

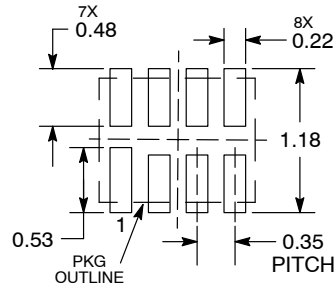

DIMENSIONS: MILLIMETERS

\*For additional information on our Pb-Free strategy and soldering details, please download the ON Semiconductor Soldering and Mounting Techniques Reference Manual, SOLDERRM/D.





