

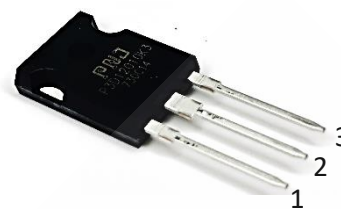

P3M171K0K3 SiC MOS N-Channel Enhancement Mode

V_{RRM} = 1700 V
 I_D = 6 A
 $I_D(100^\circ\text{C})$ = 4 A
 $R_{DS(on)}$ = 1 Ω

SiC MOS P3M171K0K3 N-Channel Enhancement Mode



Features

- High Blocking Voltage with Low On-Resistance
- High-Frequency Operation
- Ultra-Small Q_{gd}
- 100% UIS tested

Benefits

- Improve System Efficiency
- Increase Power Density
- Reduce Heat Sink Requirements
- Reduction of System Cost

Applications

- Solar Inverters
- EV Battery Chargers
- High Voltage DC/DC Converters
- Switch Mode Power Supplies

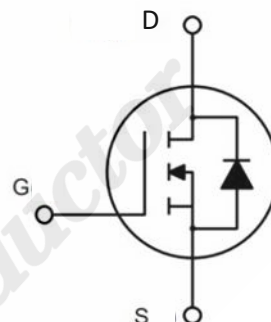

TO-247-3

Gate	1
Drain	2
Source	3



Order Information

Part Number	Package	Marking
P3M171K0K3	TO-247-3	P3M171K0K3



Contents

Features.....	1
Benefits.....	1
Applications.....	1
Order Information	1
Contents.....	2
1. Maximum Ratings.....	3
2. Electrical Characteristics	4
3. Reverse Diode Characteristics	6
4. Thermal Characteristics.....	6
5. Typical Performance	7
6. Definitions	11
7. Package Outlines.....	12

PN Junction Semiconductor



1. Maximum Ratings

At $T_J = 25^\circ\text{C}$, unless specified otherwise

Parameter	Symbol	Value	Unit	Test Conditions
Drain - Source Voltage	V_{DSmax}	1700	V	$V_{GS} = 0V$ $I_D = 200\mu A$
Gate - Source Voltage (Dynamic)	V_{GSmax}	-8 / +19	V	AC ($f > 1\text{Hz}$)
Gate - Source Voltage (Static)	V_{GSop}	-3 / +15	V	Static
Continuous Drain Current	I_D	6	A	$V_{GS} = 15V$ $T_C = 25^\circ\text{C}$
		4		$V_{GS} = 15V$ $T_C = 100^\circ\text{C}$
Power Dissipation	P_D	68	W	
Operating Junction Temperature	T_J	-55 To +175	$^\circ\text{C}$	
Storage Temperature	T_{stg}	-55 To +175	$^\circ\text{C}$	
Solder Temperature	T_L	260	$^\circ\text{C}$	
Mounting Torque	M_d	1 8.8	Nm lbf-in	M3 or 6-32 screw



2. Electrical Characteristics

At $T_J = 25^\circ\text{C}$, unless specified otherwise

Parameter	Symbol	Value			Unit	Test Conditions
		Min.	Typ.	Max.		
Drain-Source Breakdown Voltage	$V_{(BR)DSS}$	1700	/	/	V	$V_{GS} = 0V$ $I_D = 200\mu A$
Gate Threshold Voltage	$V_{GS(th)}$	1.8	2.2	/	V	(tested after 30ms pulse at $V_{GS} = 15V$) $V_{DS} = V_{GS}$ $I_D = 2mA$ $T_J = 25^\circ\text{C}$
		/	1.45	/	V	$V_{DS} = V_{GS}$ $I_D = 2mA$ $T_J = 175^\circ\text{C}$
Zero Gate Voltage Drain Current	I_{DSS}	/	2.6	200	μA	$V_{GS} = 0V$ $V_{DS} = 1700V$
Gate-Source Leakage Current	I_{GSS}	/	2	125	nA	$V_{GS} = 15V$ $V_{DS} = 0V$
Drain-Source On-State Resistance	$R_{DS(on)}$	/	1	1.4	Ω	$V_{GS} = 15V$ $I_D = 2A$ $T_J = 25^\circ\text{C}$
		/	1.4	/		$V_{GS} = 15V$ $I_D = 2A$ $T_J = 125^\circ\text{C}$
		/	1.7	/		$V_{GS} = 15V$ $I_D = 2A$ $T_J = 175^\circ\text{C}$
Transconductance	g_{fs}	/	0.29	/	S	$V_{DS} = 20V$ $I_{DS} = 2A$ $T_J = 25^\circ\text{C}$
		/	0.31	/		$V_{DS} = 20V$ $I_{DS} = 2A$ $T_J = 175^\circ\text{C}$



P3M171K0K3 SiC MOS N-Channel Enhancement Mode

Parameter	Symbol	Value			Unit	Test Conditions
		Min.	Typ.	Max.		
Input Capacitance	C_{iss}	/	235	/	pF	$V_{GS} = 0V$ $V_{DS} = 1000V$ $f = 1MHz$ $V_{AC} = 25mV$
Output Capacitance	C_{oss}	/	8.9	/		
Reverse Transfer Capacitance	C_{rss}	/	2.8	/		
Coss Stored Energy	E_{oss}	/	9.4	/	μ	
Turn-on Energy	E_{on}	/	95.7	/	μ	
Turn-off Energy	E_{off}	/	16.9	/		
Turn-On Delay Time	$T_{d(on)}$	/	15.5	/	nS	$V_{DS} = 1200V$ $V_{GS} = -3/15V$ $I_{DS} = 3A$ $R_G = 1\Omega$
Rise Time	T_r	/	16.2	/		
Turn-Off Delay Time	$T_{d(off)}$	/	15.7	/		
Fall Time	T_f	/	31.2	/		
Internal Gate Resistance	$R_{G(int)}$	/	27	/	Ω	$f = 1MHz$ $V_{AC} = 25mV$
Gate to Source Charge	Q_{gs}	/	2.2	/	nC	$V_{DS} = 1200V$ $I_{DS} = 2A$ $V_{GS} = -3 \text{ to } 15V$ $I_G = 2mA$
Gate to Drain Charge	Q_{gd}	/	2.5	/		
Total Gate Charge	Q_g	/	7.4	/		

3. Reverse Diode Characteristics

At $T_J=25\text{ }^\circ\text{C}$, unless specified otherwise

Parameter	Symbol	Value		Unit	Test Conditions
		Typ.	Max.		
Diode Forward Voltage	V_{SD}	5.1	/	V	$V_{GS} = -3V$ $I_{SD} = 1A$ $T_J = 25^\circ C$
		5.1	/	V	$V_{GS} = -3V$ $I_{SD} = 1A$ $T_J = 175^\circ C$
Continuous Diode Forward Current	I_S	5	/	A	$V_{GS} = -3V$
Reverse Recover Time	t_{rr}	35.4	/	ns	$V_{GS} = -3/15V$ $I_{SD} = 3A$ $V_R = 1200V$ $d_{if}/d_t = 650A/\mu s$ $T_J = 25^\circ C$
Reverse Recovery Charge	Q_{rr}	69.1	/	nC	
Peak Reverse Recovery Current	I_{rrm}	4.2	/	A	

4. Thermal Characteristics

Parameter	Symbol	Value	Unit
Thermal Resistance from Junction to Case	$R_{\theta JC}$	2.2	$^\circ C/W$

5. Typical Performance

At $T_J = 25^\circ\text{C}$, unless specified otherwise

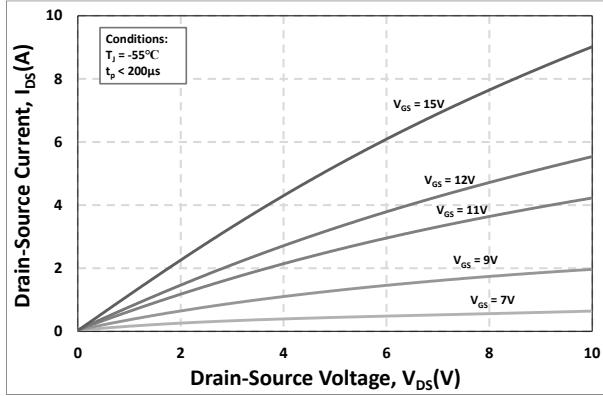

Figure 1. Output Characteristics $T_J = -55^\circ\text{C}$

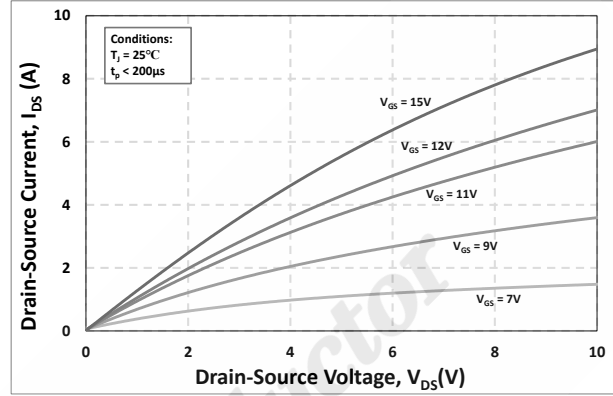

Figure 2. Output Characteristics $T_J = 25^\circ\text{C}$

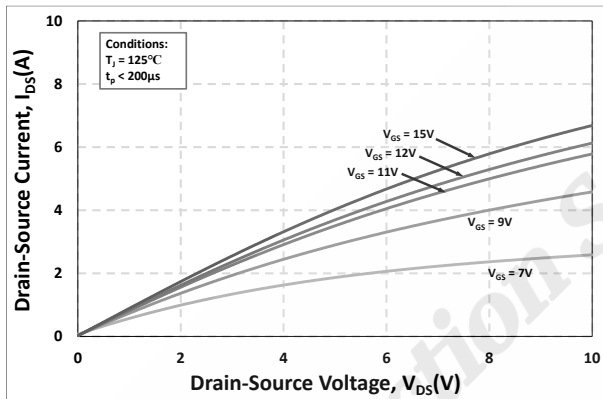

Figure 3. Output Characteristics $T_J = 125^\circ\text{C}$

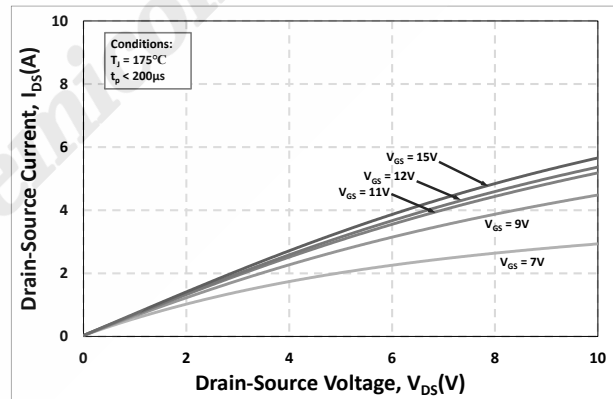

Figure 4. Output Characteristics $T_J = 175^\circ\text{C}$

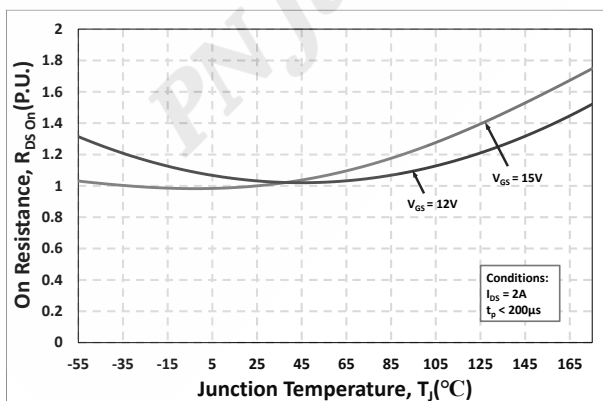

Figure 5. Normalized On-Resistance vs. Temperature

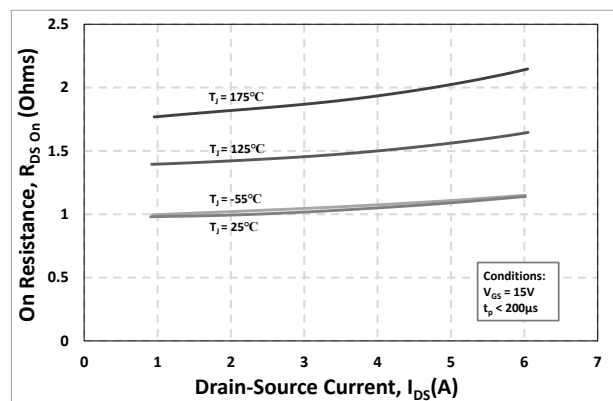

Figure 6. On-Resistance vs. Drain Current Various Temperatures

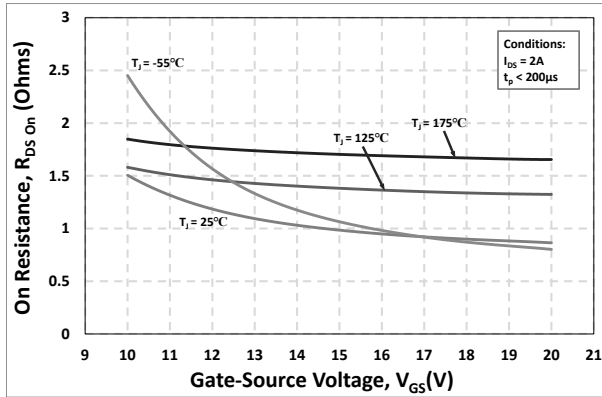

Figure 7. On-Resistance vs. Gate-Source Voltage

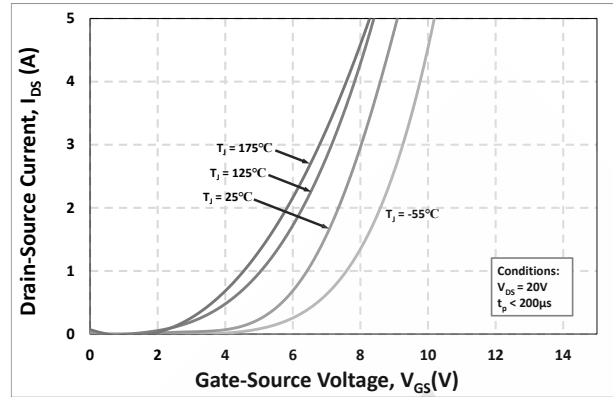

Figure 8. Transfer Characteristic for Various Junction Temperatures

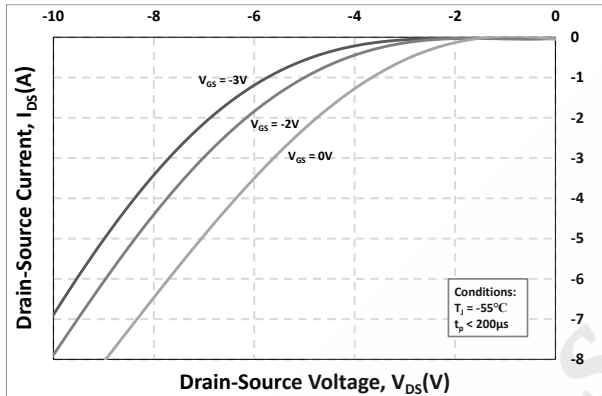

Figure 9. Body Diode Characteristic at -55°C

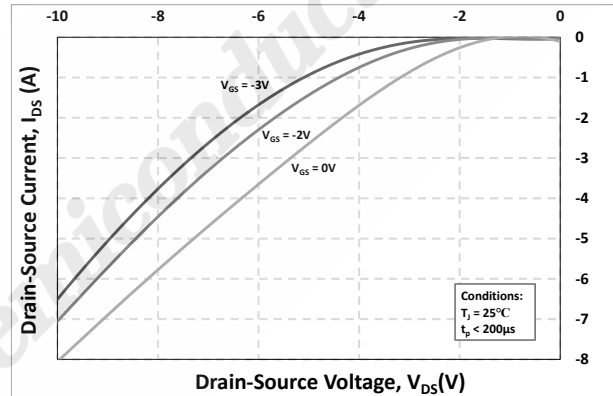

Figure 10. Body Diode Characteristic at 25°C

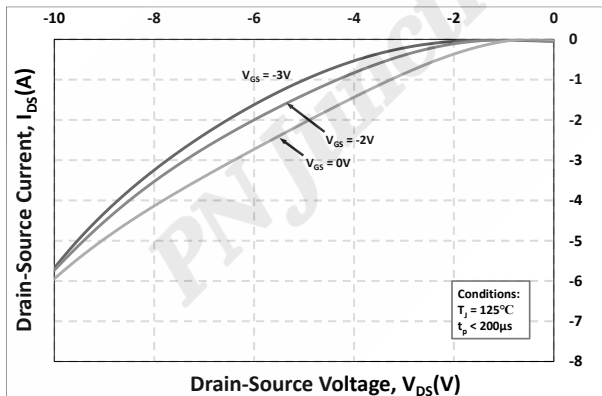

Figure 11. Body Diode Characteristic at 125°C

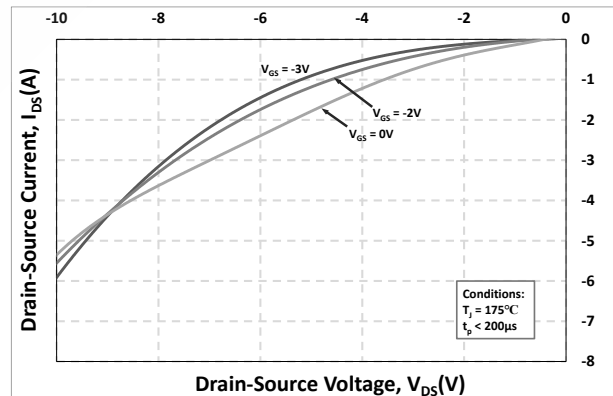

Figure 12. Body Diode Characteristic at 175°C

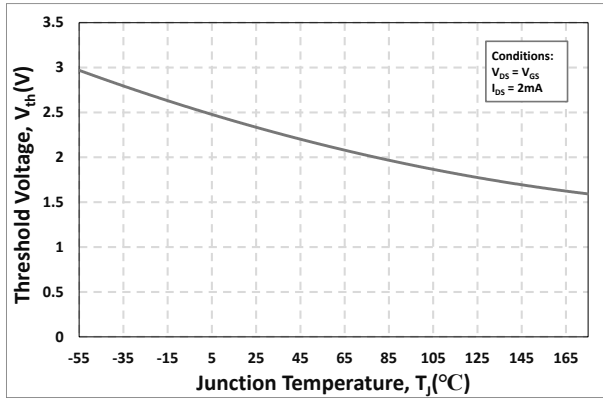

Figure 13. Threshold Voltage vs. Temperatures

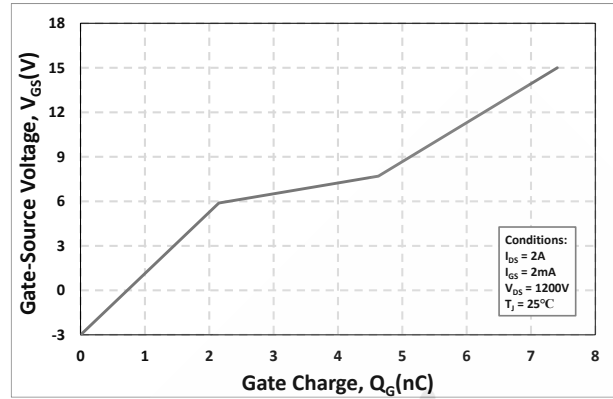

Figure 14. Gate Charge Characteristics

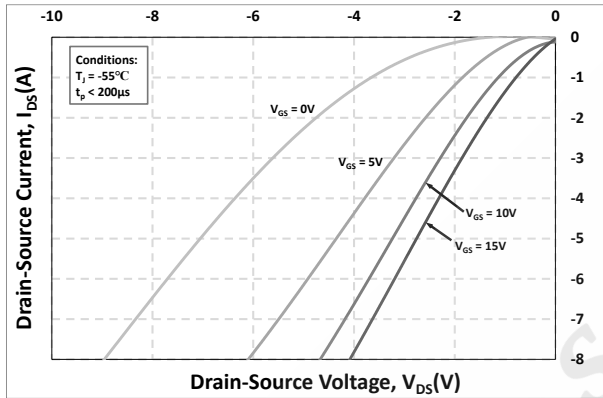

Figure 15. 3rd Quadrant Characteristic at -55°C

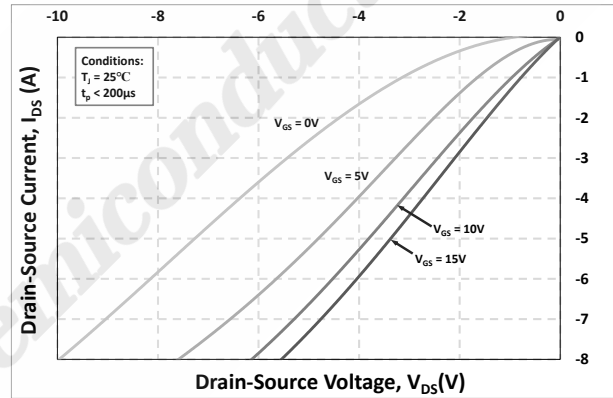

Figure 16. 3rd Quadrant Characteristic at 25°C

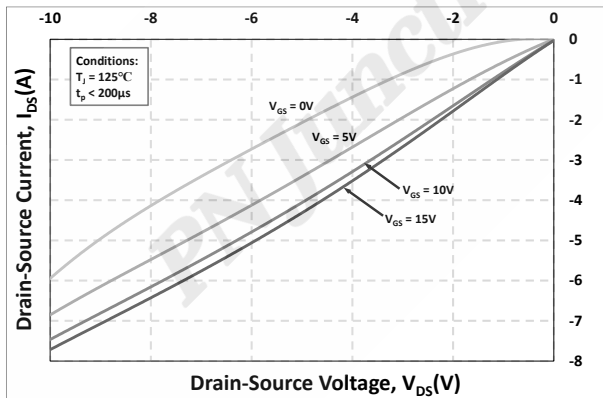

Figure 17. 3rd Quadrant Characteristic at 125°C

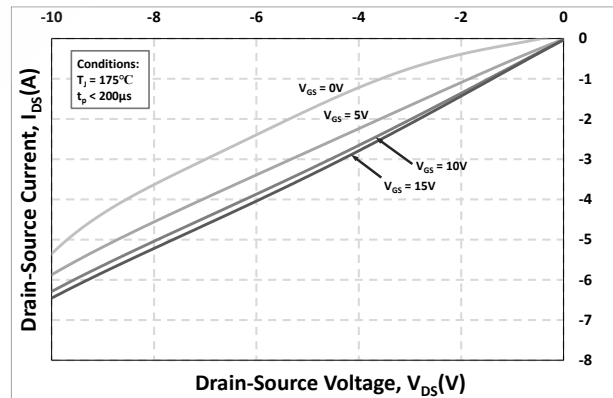

Figure 18. 3rd Quadrant Characteristic at 175°C

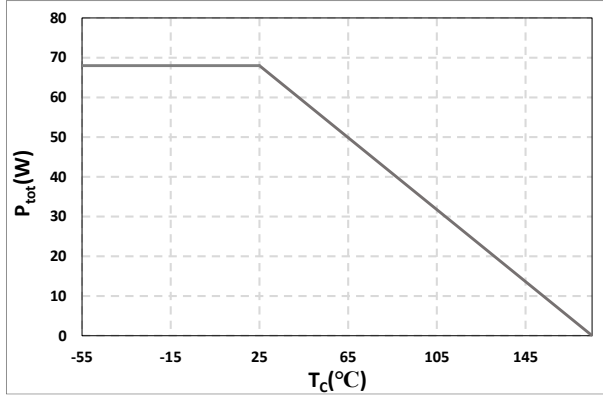

Figure 19. Maximum Power Dissipation Derating vs. Case Temperature

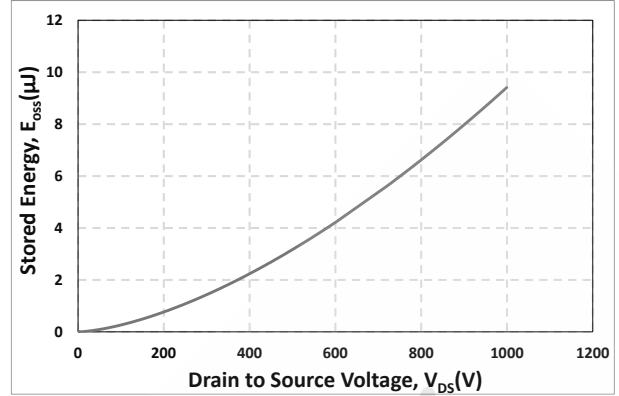

Figure 20. Output Capacitor Stored Energy

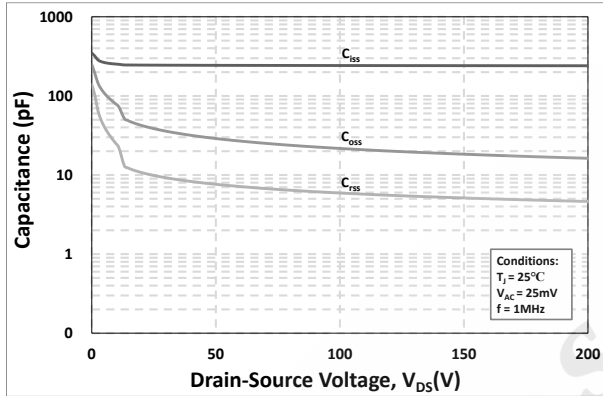

Figure 21. Capacitances vs. Drain-Source Voltage (0-200V)

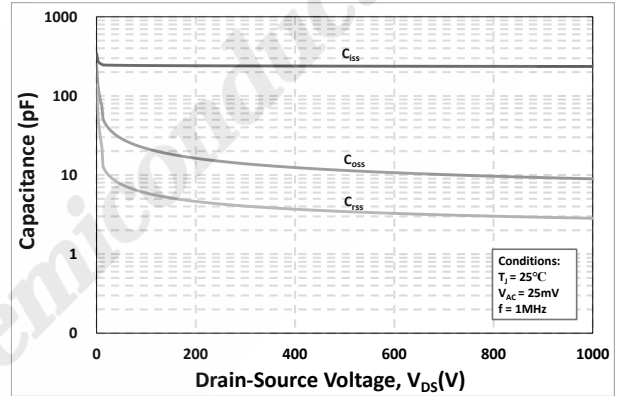

Figure 22. Capacitances vs. Drain-Source Voltage (0-1000V)

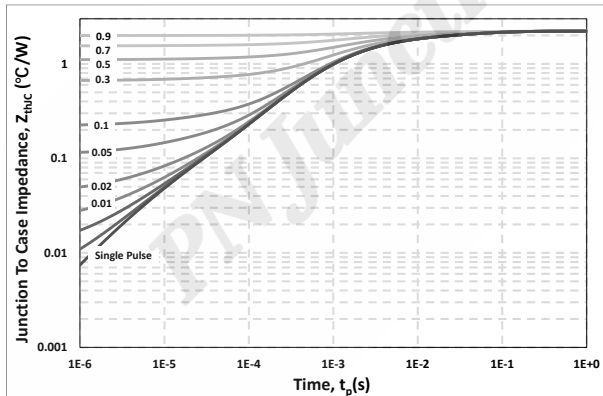

Figure 23. Transient Thermal Impedance (Junction - Case)

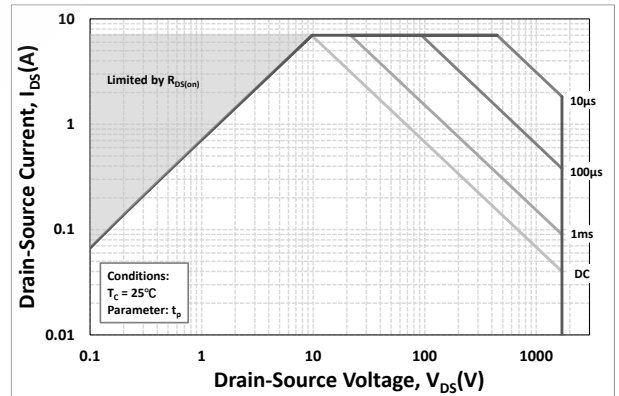

Figure 24. Safe Operating Area

6. Definitions

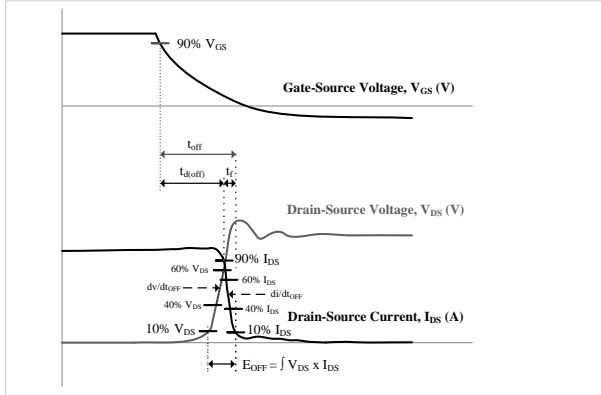

Figure 25. Turn-off Transient Definitions

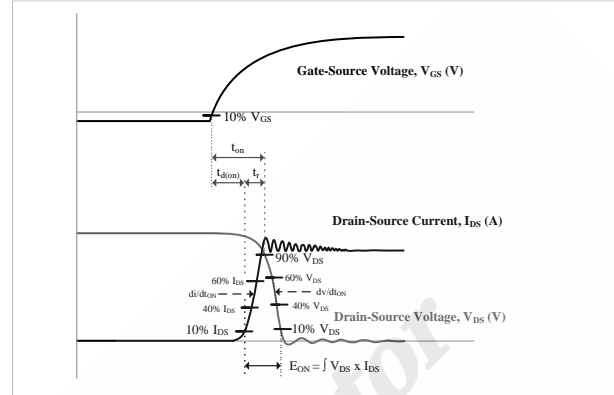

Figure 26. Turn-on Transient Definitions

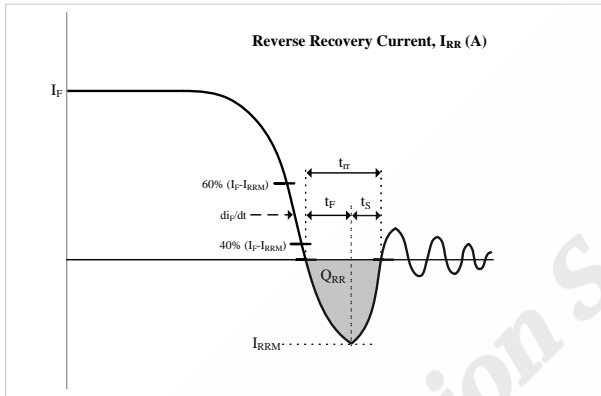

Figure 27. Reverse Recovery Definitions

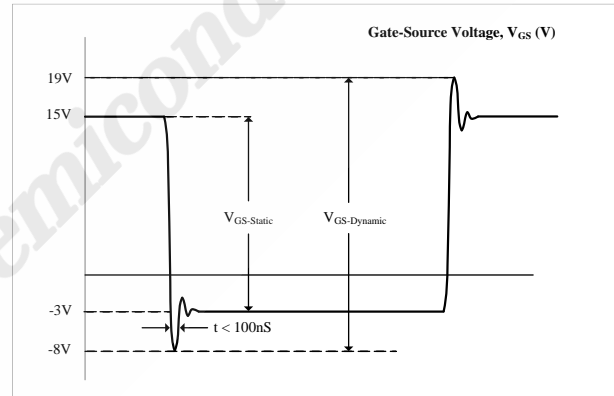
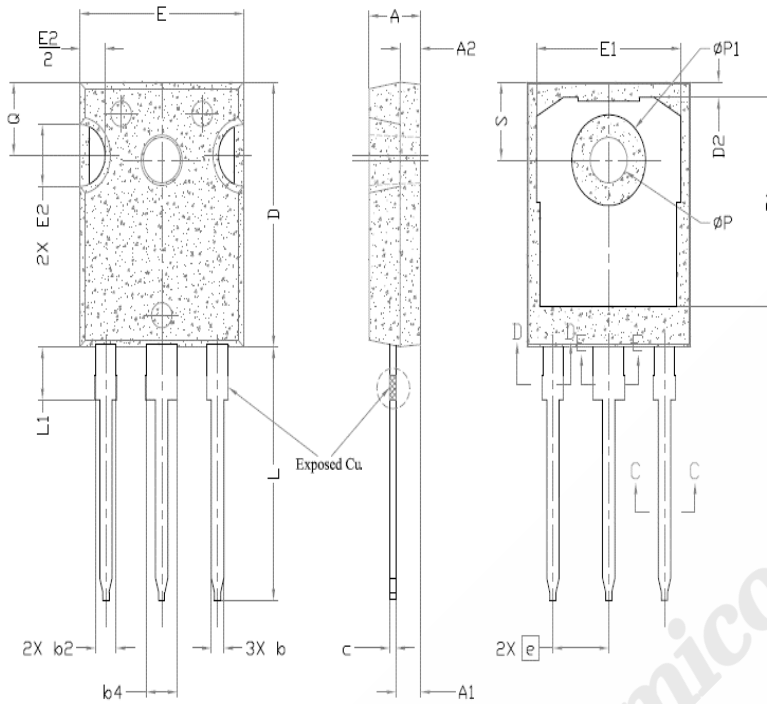

Figure 28. V_{GS} Transient Definitions

PN Junction Semiconductor

7. Package Outlines



SYMBOL	DIMENSIONS			NOTES
	MIN.	NOM.	MAX.	
A	4.83	5.02	5.21	
A1	2.29	2.41	2.55	
A2	1.50	2.00	2.49	
b	1.12	1.20	1.33	
b1	1.12	1.20	1.28	
b2	1.91	2.00	2.39	6
b3	1.91	2.00	2.34	
b4	2.87	3.00	3.22	6, 8
b5	2.87	3.00	3.18	
c	0.55	0.60	0.69	6
c1	0.55	0.60	0.65	
D	20.80	20.95	21.10	4
D1	16.25	16.55	17.65	5
D2	0.51	1.19	1.35	
E	15.75	15.94	16.13	4
E1	13.46	14.02	14.16	5
E2	4.32	4.91	5.49	3
e	5.44BSC			
L	19.81	20.07	20.32	
L1	4.10	4.19	4.40	6
ϕP	3.56	3.61	3.65	7
$\phi P1$	7.19REF.			
Q	5.39	5.79	6.20	
S	6.04	6.17	6.30	

Drawing and Dimensions

PN Junction Semiconductor



Important Notice

The information given in this document shall in no event be regarded as a guarantee of conditions or characteristics. With respect to any examples, hints or any typical values stated herein and/or any information regarding the application of the product, PN Junction hereby disclaims any and all warranties and liabilities of any kind, including without limitation warranties of non-infringement of intellectual property rights of any third party.

PN Junction reserves the right to make changes at any time to any products or information herein, without notice. "Typical" parameters which may be provided in PN Junction data sheets and/or specifications can and do vary in different applications and actual performance may vary over time. All operating parameters, including "Typical" must be validated for each customer application by customer's technical experts.

In addition, any information given in this document is subject to customer's compliance with its obligations stated in this document and any applicable legal requirements, norms and standards concerning customer's products and any use of the product of PN Junction in customer's applications. The data contained in this document is exclusively intended for technically trained staff. It is the responsibility of customer's technical departments to evaluate the suitability of the product for the intended application and the completeness of the product information given in this document with respect to such application.

For further information on the product, technology, delivery terms and conditions and prices please contact your nearest PN Junction office (www.pnjsemi.com).

Warnings

Due to technical requirements products may contain dangerous substances. For information on the types in question please contact your nearest PN Junction office.

Except as otherwise explicitly approved by PN Junction in a written document signed by authorized representatives of PN Junction, PN Junction's products may not be used in any applications where a failure of the product or any consequences of the use thereof can reasonably be expected to result in personal injury.