

**Mechanical Dimensions: Inches [mm]**

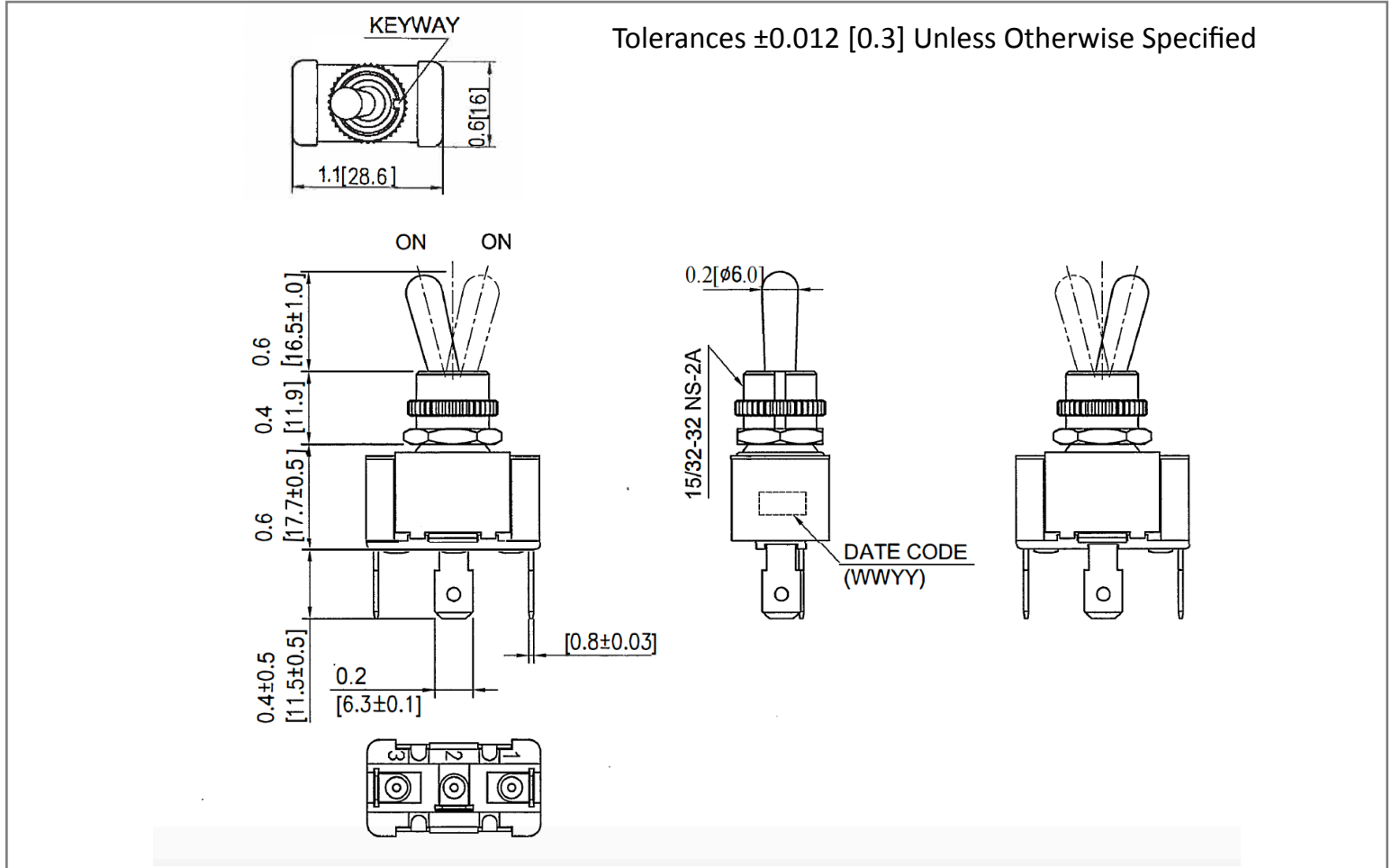

**Mounting Hole**

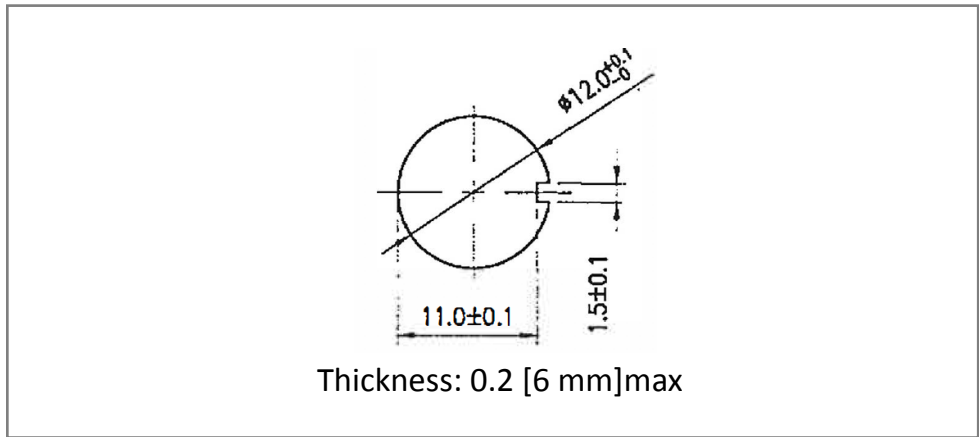

**Circuit Diagram**

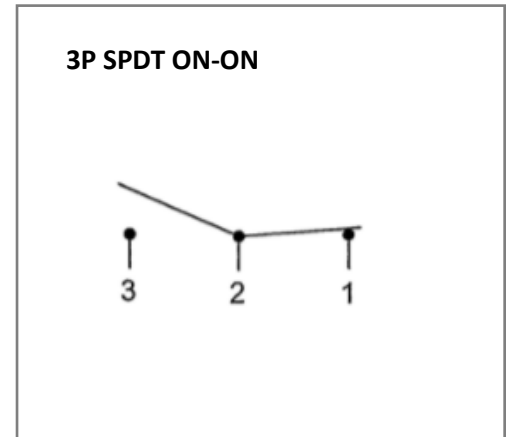

**Electrical Specifications**

Rating	21A 14V DC
Contact Resistance	50m ohm Max
Insulation Resistance	DC 500V 100M ohm Min
Dielectric Strength	AC 1500V 1 minute
Operation Temperature	-20°C ~ 85°C

**Material Specifications**

Operation Force	700gf $\pm$ 250gf
	1 hex nut assy
	1 knurl nut assy

Rev	Date of issue	Revision Notes	Designed	Approved
A	02-13-2019	Initial Drawing	RC	OH