

## Coupler connector - ST-7ES1N8A9K04S - 1618718

Please be informed that the data shown in this PDF Document is generated from our Online Catalog. Please find the complete data in the user's documentation. Our General Terms of Use for Downloads are valid (<http://phoenixcontact.com/download>)



Coupler connector, straight, for standard and SPEEDCON interlock, M17, number of positions: 7+PE, type of contact: Socket, Crimp connection, shielded: yes, cable diameter range: 9 mm ... 11.2 mm

### Your advantages

- ✓ Reduced size: ideal for compact devices
- ✓ Consistent EMC protection for reliable connection solutions in the industrial environment
- ✓ Crimping connection: vibration- and temperature-resistant assembly
- ✓ Flexible use: reliably connect various cable diameters

### Key Commercial Data

Packing unit	1 pc
GTIN	
GTIN	4046356811811

### Technical data

#### General

Note	Order information: Order crimp contacts Ø 1 mm separately
Type of locking	for standard and SPEEDCON interlock
Direction of rotation of contact chamber numbering	Standard
Coding	N
Contact connection method	Crimp connection
Type of contacts	Socket
Number of positions	8
Contact diameter of power contacts	1 mm
Nominal current per power contact at 25°C	14 A
Contact diameter of signal contacts	1 mm
Conductor entry	9 mm ... 11.2 mm
Pg housing screw connection	none

## Coupler connector - ST-7ES1N8A9K04S - 1618718

### Technical data

#### Ambient conditions

Ambient temperature	-40 °C ... 125 °C
Degree of protection	IP67

#### Specifications according to DIN EN 61984:2001

Installation height max.	3000 m
Nominal / operating voltage of power contacts	630 V
Rated surge voltage of power contacts	6 kV
Overvoltage category of power contacts	III
Degree of pollution of power contacts	3

#### Environmental Product Compliance

	Lead 7439-92-1
China RoHS	Environmentally Friendly Use Period = 50
	For details about hazardous substances go to tab "Downloads", Category "Manufacturer's declaration"

### Drawings

## Coupler connector - ST-7ES1N8A9K04S - 1618718

Schematic diagram



Connector pin assignment

# Coupler connector - ST-7ES1N8A9K04S - 1618718

Dimensional drawing

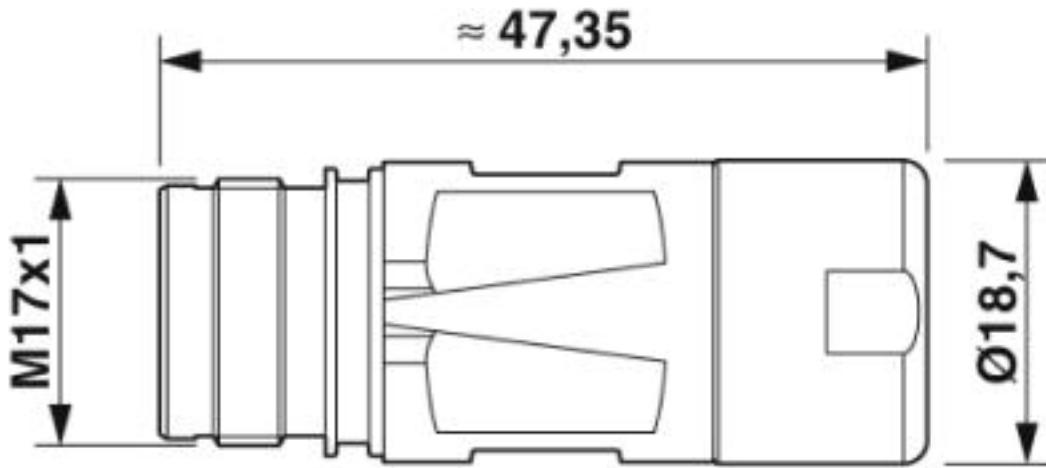

## Approvals

Approvals

Approvals

UL Recognized / cUL Recognized / EAC / cULus Recognized

Ex Approvals

## Approval details

UL Recognized		<a href="http://database.ul.com/cgi-bin/XYV/template/LISEXT/1FRAME/index.htm">http://database.ul.com/cgi-bin/XYV/template/LISEXT/1FRAME/index.htm</a>	FILE E 335019
Nominal voltage UN	600 V		
Nominal current IN	5 A		
mm <sup>2</sup> /AWG/kcmil	18		

cUL Recognized		<a href="http://database.ul.com/cgi-bin/XYV/template/LISEXT/1FRAME/index.htm">http://database.ul.com/cgi-bin/XYV/template/LISEXT/1FRAME/index.htm</a>	FILE E 335019
Nominal voltage UN	600 V		
Nominal current IN	5 A		
mm <sup>2</sup> /AWG/kcmil	18		

## Coupler connector - ST-7ES1N8A9K04S - 1618718

### Approvals



Phoenix Contact 2019 © - all rights reserved  
<http://www.phoenixcontact.com>

PHOENIX CONTACT GmbH & Co. KG  
Flachsmarktstr. 8  
32825 Blomberg  
Germany  
Tel. +49 5235 300  
Fax +49 5235 3 41200  
<http://www.phoenixcontact.com>