

EA2802QL-T1028 User's Guide

5V/2.1A Power Bank Solution

Description

This document supports the **EA2802QL-T1028** Evaluation Kit. This kit is a proven application circuit design for the EA2802QL-T1028 charger with power path and single USB outputs. The EVK contains a single micro-USB input and USB output. It provides the output with 2.1A. It is configured to charge a battery with 2.1A. The EVK operates with very high charge efficiency of 89% and discharge efficiency of 95% (Vbat=4.1V). The EVK contains the ACT2802QL-T1028, but it can also be used to evaluate the ACT2802BQL-T1028 and ACT2802CQL-T1028 with minor modifications. Refer to the EVK BOM for the component change details. The ACT2802QL-T1028 has a battery temperature monitor function while the ACT2802BQL-T1028 and ACT2802CQL-T1028 have flashlight functions.

PART NUMBER	OUTPUT	FLASHLIGHT	TH	PB TURN OFF BOOST	LEDS ALWAYS ON IN BOOST	PACKAGE
ACT2802QL-T1028	5V/2.5A	No	Yes	Yes	No	QFN44-24
ACT2802BQL-T1028	5V/2.5A	Yes	No	No	Yes	QFN44-24
ACT2802CQL-T1028	5V/2.5A	Yes	No	No	No	QFN44-24

Features

The EVK contains a high efficiency Buck and Boost DC/DC converter that operates either in CV (Constant Voltage) mode or CC(Constant Current) mode. The EVK provides up to 5V/2.1A output at 550 KHz switching frequency. It operates from Vin=4.5V to 5.5V to charge battery. Gerber files are available to minimize time-to-market for applications that want to use the EVK as an end product.



Figure 1 – EVK Picture - Top



Figure 2 – EVK Picture - Bottom

Setup

Required Equipment

EA2802QL-T EVK

Power supply – 5V @ 3.5A for full power operation

Oscilloscope – >100MHz

Loads –Electronic/resistive load with 3A minimum current capability.

Digital Multimeters (DMM)

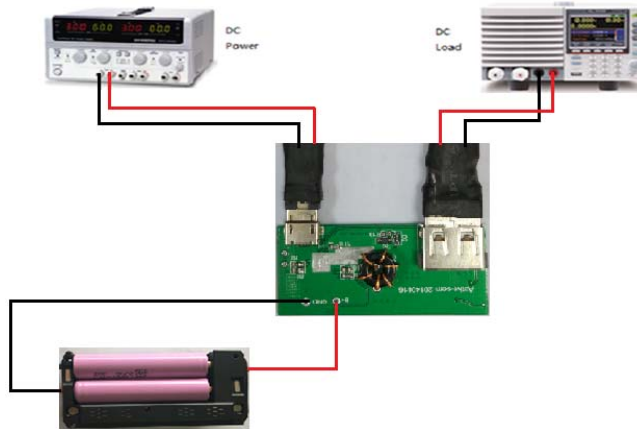

Figure 3 – EVK Setup

Hardware Setup

1. Connect a DC power supply across Vin and GND on the EVK.
2. Connect the EVK output to electronic load by USB connector.
3. Connect battery across B+ and GND.
4. Recommended Operating Conditions.

Table1. Recommended Operating Conditions

Parameter	Description	Min	Typ	Max	Unit
VIN	All buck input voltages	4.5	5	5.5	V
IOUT	Maximum load current		2.1		A

EVK Operation

Turn on

Apply 5V to input.

PCB Layout

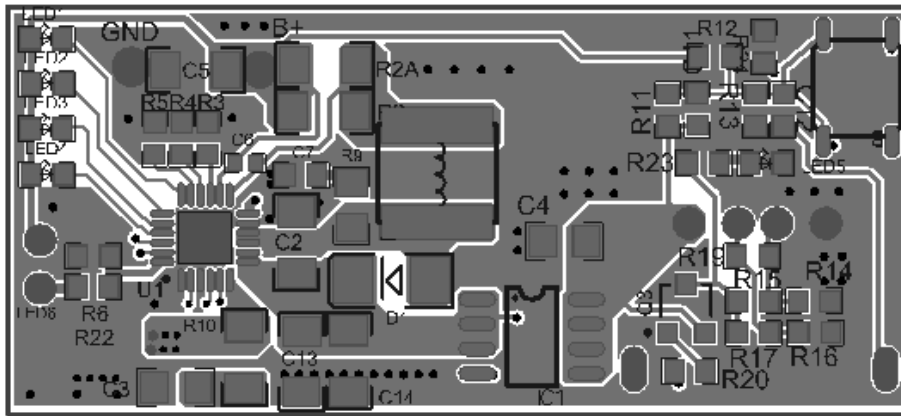

Top Layer

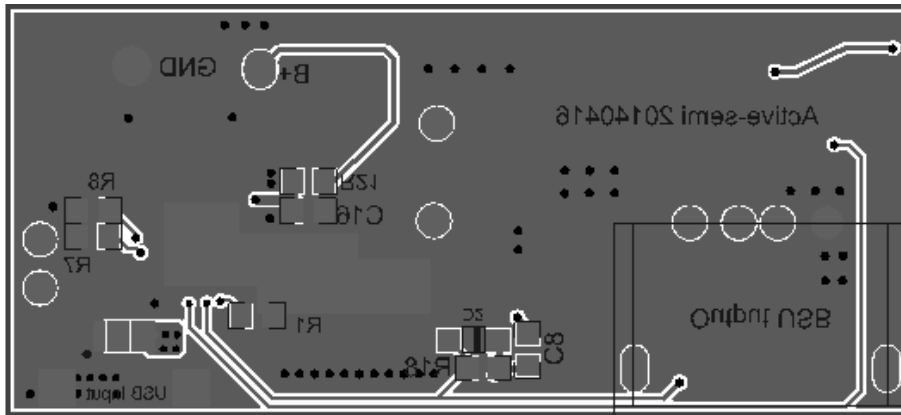

Bottom Layer

Test Results

Power Path Function

Input current(mA)	1698	1802	1909	2213	2429	2501	2506	2510	2535	2561	2603	2637	2652	2656
Output current(mA)	0	100	200	500	700	800	850	900	1200	1500	2000	2400	2600	2650
Charge current(mA)	2156	2154	2154	2154	2152	2118	2063	2009	1684	1352	780	292	65	0

(Test condition: Vin=5 V, Vbat=3.7V, input current limit=3.2A, fast charge current=2.1A)

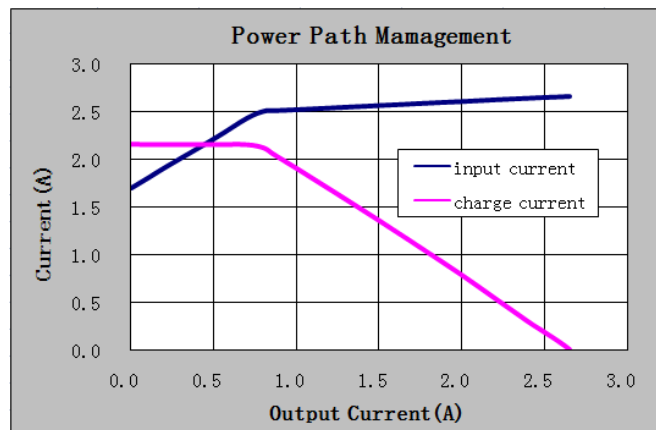

Charge Efficiency

(Vin=5V and charge current set at 210mA)

Battery Voltage (V)	3.0	3.2	3.5	3.7	4.1
Efficiency (%)	88.1	88.1	88.4	88.5	88.04

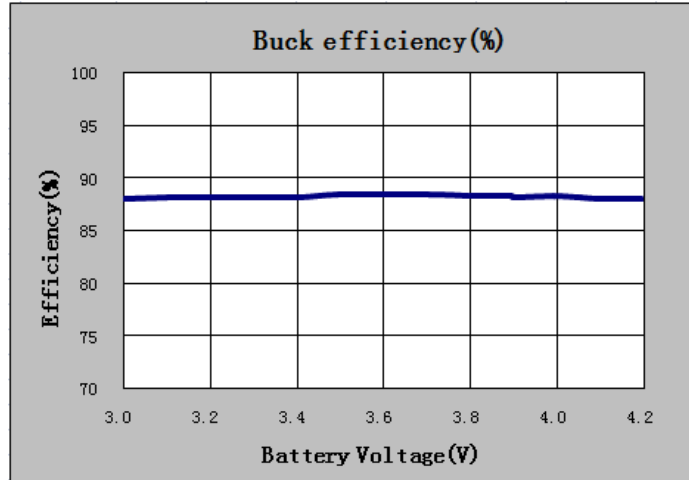

Boost Efficiency and Power Loss (Ta=25°C)

Vbat	Efficiency (%)				
	Io=100mA	Io=500mA	Io=1000mA	Io=1500mA	Io=2100mA
3.2V	90.7	93.2	93.6	92.0	89.2
3.7V	91.6	94.2	94.8	93.7	91.8
4.1V	95.3	94.9	95.9	95.1	93.7

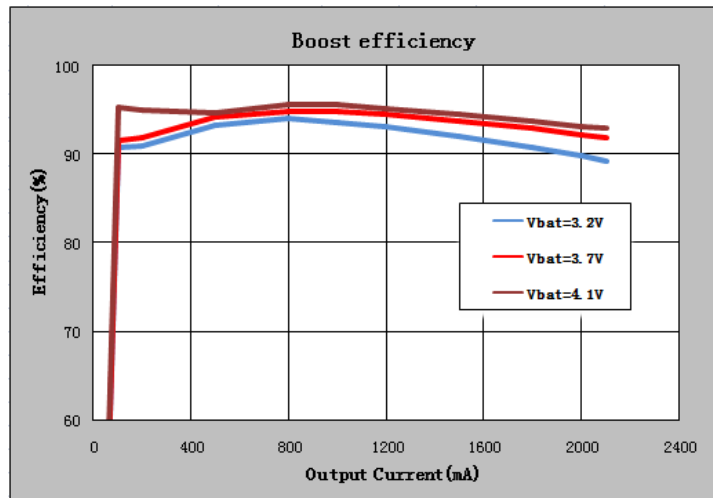

Vbat	Power Loss (W)				
	Io=500mA	Io=1000mA	Io=1500mA	Io=2000mA	Io=2100mA
3.2V	0.18	0.35	0.66	1.14	1.27
3.7V	0.15	0.28	0.50	0.85	0.94
4.1V	0.13	0.22	0.39	0.67	0.71

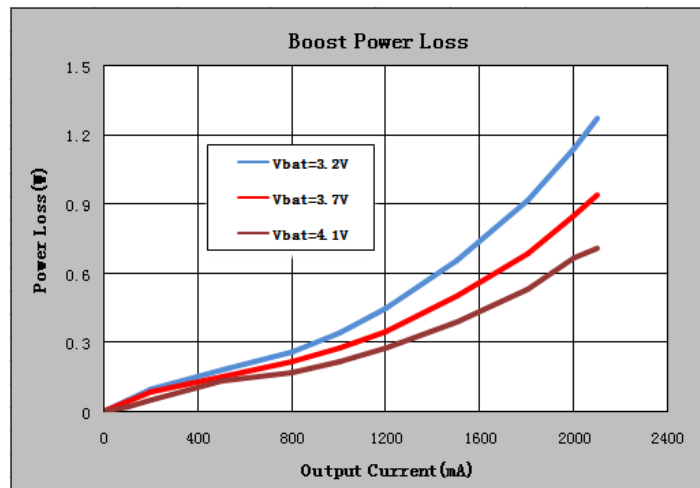

Boost Constant Current and Constant Voltage Regulation (Ta=25°C)

	Vbat=3.2V		Vbat=3.7V		Vbat=4.15V	
	Vout(V)	Iout(mA)	Vout (V)	Iout(mA)	Vout(V)	Iout(mA)
CC Load	5.049	0	5.055	0	5.057	0
	5.031	500	5.033	500	5.033	500
	5.019	1000	5.019	1000	5.018	1000
	4.98	2400	4.992	2000	4.987	2400
CV Load	4.95	2451	4.98	2483	4.96	2512
	4.81	2452	4.83	2486	4.81	2516
	4.75	2455	4.75	2488	4.74	2517
	4.60	2460	4.60	2492	4.61	2520
	4.51	2463	4.51	2495	4.52	2522
	4.40	2467	4.40	2499	4.41	2525
	4.30	2471	4.30	2501	4.31	2528
	4.26	2473	4.25	2504	4.25	2529
	4.20	2475	4.20	2505	4.19	2530
	4.18	2478	4.18	2509	4.18	2530
	4.17	0	4.17	0	4.17	0
	4.10	0	4.10	0	4.10	0
	3.5	0	3.5	0	3.5	0
	3.0	0	3.0	0	3.0	0

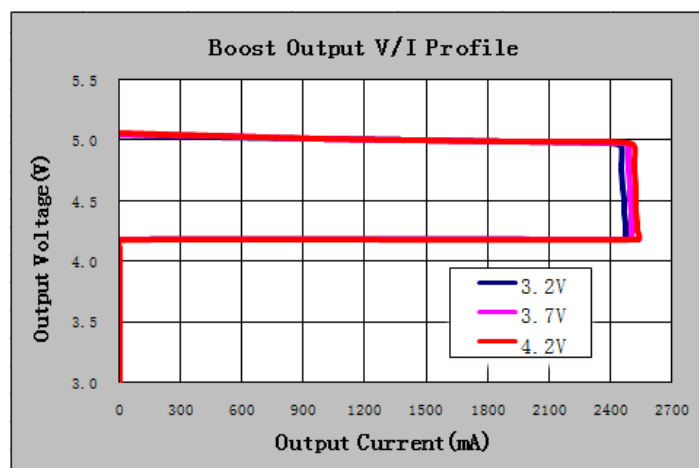

Battery Leakage Current in HZ Mode

Test Conditions	Battery Input Current (μA)	Power Loss (μW)
Vbat=2.8V	5.1	14.3
Vbat=3.2V	5.8	18.6
Vbat=3.7V	6.4	23.7
Vbat=4.2V	7.2	30.2

Ripple and Noise

Ripple & noise are measured by using 20MHz bandwidth limited oscilloscope.

Test Conditions	Output Ripple at 1A Load (mV)	Output Ripple at 2.1A Load (mV)
Vbat=3.2V	20	64.8
Vbat=3.7V	16.8	49.6
Vbat=4.1V	15.2	39.2

Load Dynamic Response Load Step(Vbat=3.7V)

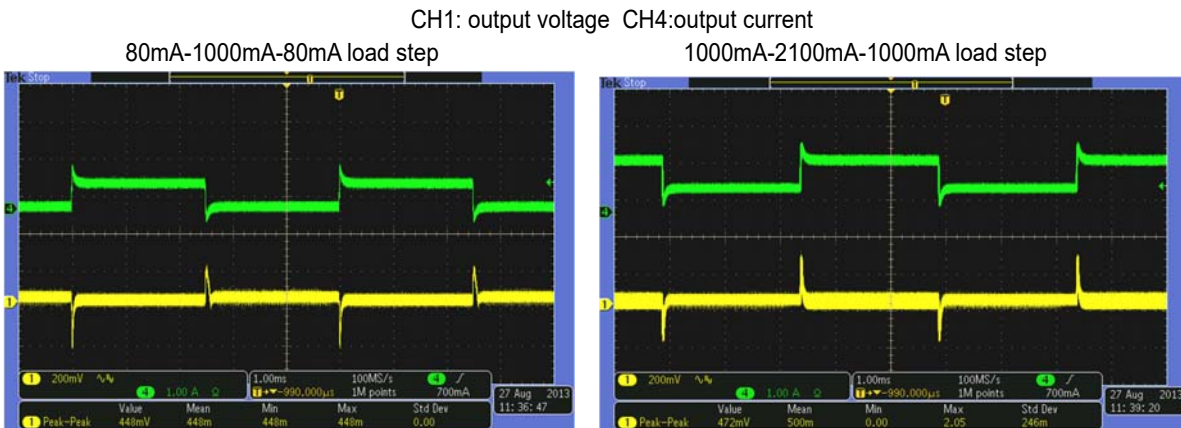

LED Indication

Conventional LED indication

PB time>30ms (HZ Mode)	LED1	LED2	LED3	LED4
VBAT<VLED1	Off	Off	Off	Off
VLED1≤VBAT<VLED2	On	Off	Off	Off
VLED2≤VBAT<VLED3	On	On	Off	Off
VLED3≤VBAT<VLED4	On	On	On	Off
VBAT≥VLED4	On	On	On	On

Charge Mode	LED1	LED2	LED3	LED4
$V_{BAT} < V_{LED1}$	Flash	Off	Off	Off
$V_{LED1} \leq V_{BAT} < V_{LED2}$	Flash	Off	Off	Off
$V_{LED2} \leq V_{BAT} < V_{LED3}$	On	Flash	Off	Off
$V_{LED3} \leq V_{BAT} \leq V_{LED4}$	On	On	Flash	Off
$V_{LED4} \leq V_{BAT} \leq \text{EOC Mode}$	On	On	On	Flash
$LED4 \leq V_{BAT} (\text{EOC Mode})$	On	On	On	On

System Management

ACT2802 System Operation Flow Chart

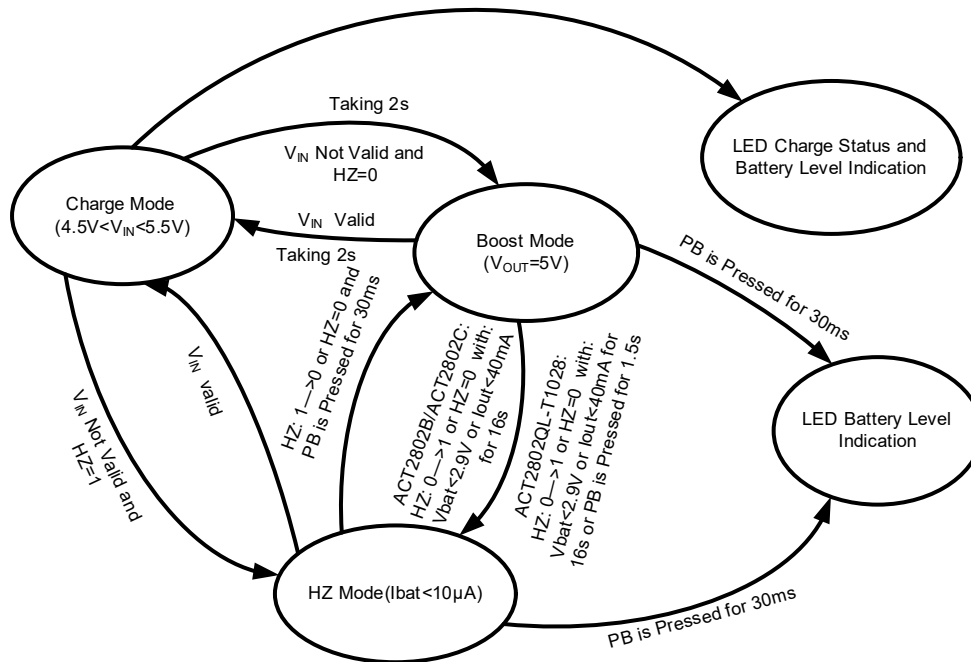

Key Components Temperature Test (Ta=40°C, burning for 2 hours)

Charge mode, 2.0A charge current

Vin(V)	IC(°C)	Inductor(°C)	PCB(°C)	Vbat(V)
5.0	68	60.2	52	3.2
5.0	69	62.1	54	3.7
5.0	68.2	61.6	53.7	4.1

Discharge mode, 2.1A output current

Vbat(V)	IC(°C)	Inductor(°C)	PCB(°C)	Vout(V)
3.2	87.5	86.5	78.2	5.0
3.7	74.2	76.8	68.6	5.0
4.1	65.3	68.6	62.4	5.0

PCB Layout Guidance

The following guideline is base on the schematic.

- 1) Arrange the power components to reduce the AC loop size that consists of C2, VOUT, SW and PGND. C2(1206 size) must be placed close to the IC and across the VOUT and PGND traces and SW trace goes under the C2.
- 2) Use copper plane for PGND for best heat dissipation and noise immunity. AGND and PGND are connected under the IC thermal pad with 4x4 vias matrix.
- 3) SW copper area should be limited due to EMI consideration.
- 4) Use Kevin sense from sense resistor R2 and R2A to CSP and CSN pin.
- 5) A separate trace is from VBAT input to BAT pin for battery voltage sense accuracy.
- 6) RC snubber is recommended to add across SW to PGND to reduce EMI noise.
- 7) A 10V/3.0A schottky is added from inductor terminal to VOUT to reduce EMI noise.

EMI Test

Vbat=4.1V, Output: 5V/2A Horizontal

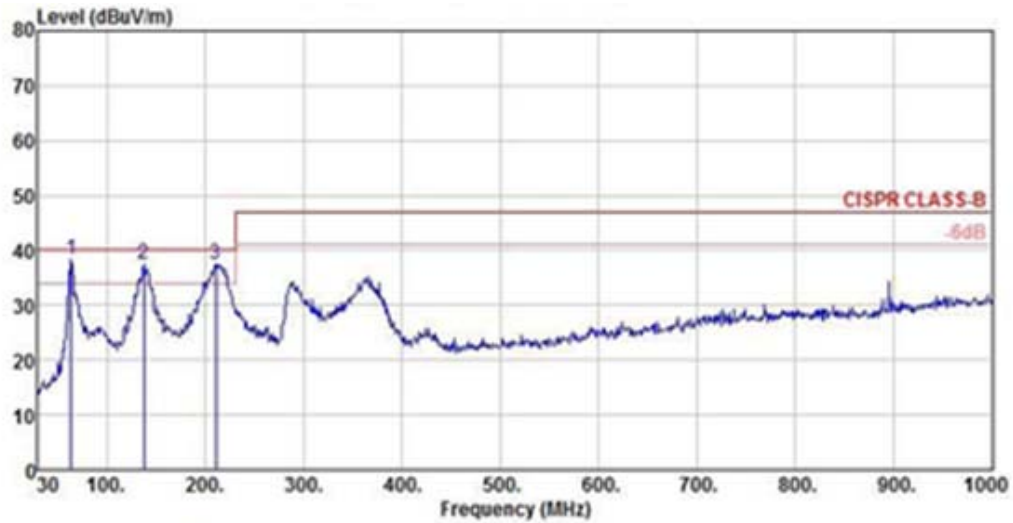

```

Site      : chamber
Condition : CISPR CLASS-B 3m VULB9160 HORIZONTAL
EUT       :
Model Name : ACT2802 5V2A BOOST VBAT=4.1V
Temp/Humi : 24 °C /58%
Power Rating: dc
Mode      :
Memo      :
           : #2
  
```

	ReadAntenna	Cable	Preamp	Limit	Over			
Freq	Level	Factor	Loss	Factor	Level	Line		
MHz	dBuV	dB/m	dB	dB	dBuV/m	dBuV/m		
1 pp	63.95	24.96	12.34	1.07	0.00	38.37	40.00	-1.63 Peak
2	137.67	22.55	13.21	1.62	0.00	37.38	40.00	-2.62 Peak
3	210.42	24.86	10.57	1.94	0.00	37.37	40.00	-2.63 Peak

Vbat=4.1V, Output: 5V/2A Vertical

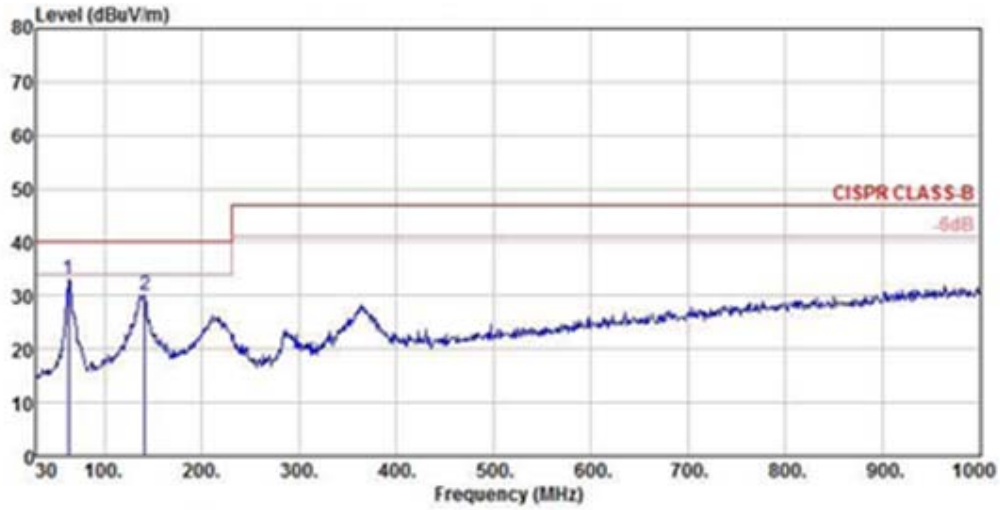

```

Site       : chamber
Condition  : CISPR CLASS-B 3m VULB9160 VERTICAL
EUT        :
Model Name : ACT2802 5V2A BOOST VBAT=4.1V
Temp/Humi  : 24 °C /58%
Power Rating: dc
Mode       :
Memo       :
            : #2
  
```

	Freq	ReadAntenna	Cable	Preamp	Limit	Over		
	MHz	Level	Loss	Factor	Line	Limit	Remark	
		dBuV	dB/m	dB	dB	dBuV/m	dBuV/m	
1 pp	62.98	19.62	12.51	1.07	0.00	33.20	40.00	-6.80 Peak
2	141.55	14.97	13.47	1.62	0.00	30.06	40.00	-9.94 Peak

Schematic

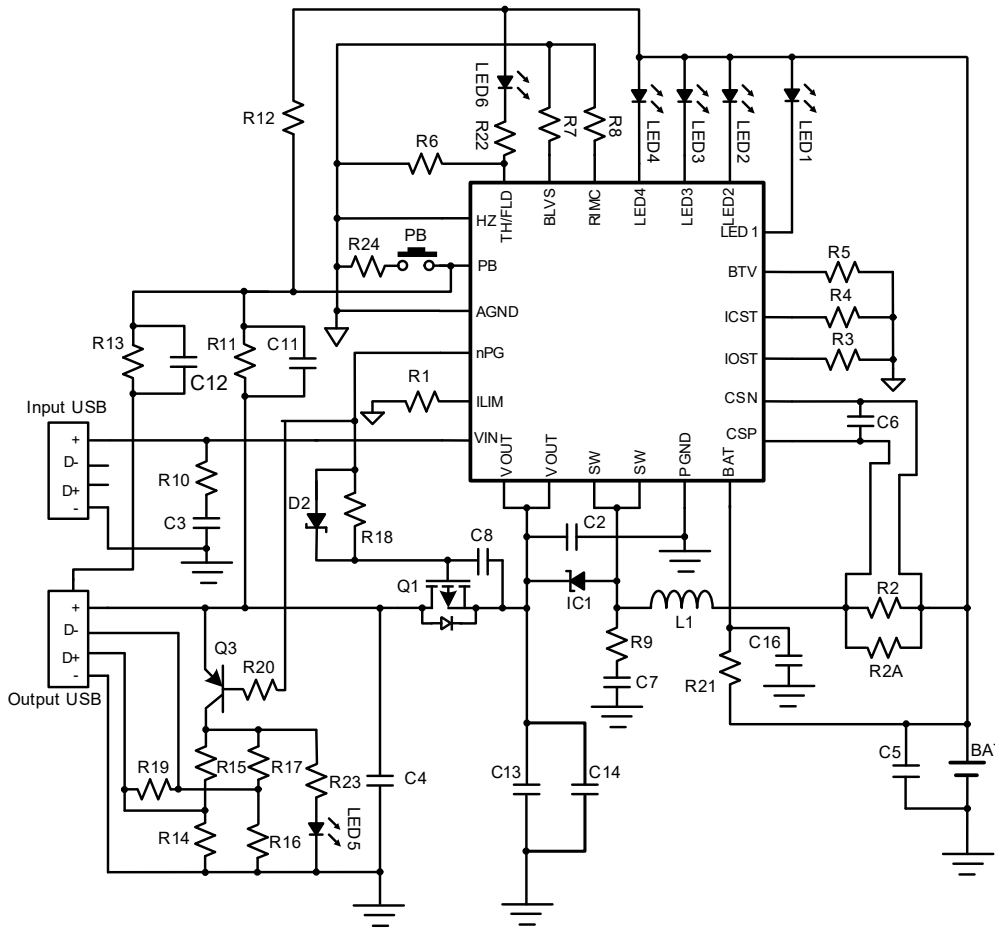

Bill of Materials

Item	Reference	Description	QTY		Manufacturer
			EA2802QL-T1028	Components for ACT2802BQL- T1028 and ACT2802CQL- T1028	
1	L1	2.2uH 6*3*3 coil Φ0.55mm 6A	1	1	
2	IC1	AO4453,Rdson=19mΩ at GS=-4.5V	1	1	AOS
3	Q3	MMBT3906	1	1	Vishay
4	D1	SS12,Vf=0.5V, 20V Schottky	1	1	Diodes
5	D2	IN4148, Vf=0.7V, 75V Fast Swith Diode	1	1	Philips
6	C2,C5, C13,C14	Ceramic capacitor, 22uF/10V, X7R, 1206	3	3	Murata/TKD
7	C3	Ceramic capacitor, 4.7uF/10V, X7R, 0805	1	1	Murata/TKD
8	C4	Ceramic capacitor, 0.1uF/10V, X7R, 0603	1	1	Murata/TKD
9	C6	Ceramic capacitor, 10nF/10V, X7R, 0603	1	1	Murata/TKD
10	C7	Ceramic capacitor, 4.7nF/10V, X7R, 0603	1	1	Murata/TKD
11	C8,C11, C12, C16	Ceramic capacitor, 2.2uF/10V, X7R, 0603	4	4	Murata/TKD
12	R1	Chip Resistor, 750Ω, 1/10W, 1%, 0603	1	1	Murata/TKD
13	R2,R2A	Chip Resistor, 50mΩ, 1/4W, 1%, 1206	2	2	Sart
14	R3	Chip Resistor, 93.1kΩ, 1/10W, 1%, 0603	1	1	Murata/TKD
15	R4,R15	Chip Resistor, 43.2kΩ, 1/10W, 1%, 0603	2	2	Murata/TKD
16	R5	Chip Resistor, 25kΩ, 1/10W, 1%, 0603	1	1	Murata/TKD
17	R6	Chip Resistor, 10kΩ, 1/10W, 5%, 0603	1	0	Murata/TKD
18	R7	Chip Resistor, 60kΩ, 1/10W, 1%, 0603	1	1	Murata/TKD
19	R8	Chip Resistor, 100kΩ, 1/10W, 1%, 0603	1	1	Murata/TKD
20	R9	Chip Resistor, 1Ω, 1/8W, 5%, 0805	1	1	Murata/TKD
21	R10	Chip Resistor, 2.7Ω, 1/4W, 5%, 1206	1	1	Murata/TKD
22	R11	Chip Resistor, 200kΩ, 1/10W, 5%, 0603	1	1	Murata/TKD
23	R12,R13	Chip Resistor, 715kΩ, 1/10W, 5%, 0603	2	2	Murata/TKD
24	R14,R16	Chip Resistor, 49.9kΩ, 1/10W, 1%, 0603	2	2	Murata/TKD
25	R17	Chip Resistor, 75kΩ, 1/10W, 1%, 0603	1	1	Murata/TKD
26	R18,R20	Chip Resistor, 100kΩ, 1/10W, 5%, 0603	2	2	Murata/TKD
27	R19	Chip Resistor, 100Ω, 1/10W, 5%, 0603	0	0	Murata/TKD
28	R21	Chip Resistor, 2.2Ω, 1/10W, 5%, 0603	1	1	Murata/TKD

29	R22	Chip Resistor, 51Ω, 1/8W, 5%, 0805	0	1	Murata/TDK
30	R23	Chip Resistor, 1kΩ, 1/10W, 5%, 0603	0	0	Murata/TDK
31	R24	Chip Resistor, 100Ω, 1/10W, 5%, 0603	1	1	Murata/TDK
32	LED1,LED2 LED3,LED4	LED, 0603, Blue	4	4	
33	LED5	LED, 0603, Blue	0	0	
34	LED6	flashlight	0	1	
35	PB	Push Button	1	1	
36	USB	10.2*14.6*7mm, 4P, DIP, 90°	1	1	
37	Micro-USB	MICRO USB 5P/F SMT B	1	1	
38	U1	IC, ACT2802QL-T1028,QFN 44-24	1	0	Active Semi
		IC, ACT2802BQL-T1028 / ACT2802CQL-T1028,QFN 44-24	0	1	Active Semi