

Product Datasheet

JD063A-C

HPE® Compatible 1.25Gb/s 550m SFP Transceiver

Hot Pluggable, Duplex LC, +3.3V, 850nm, VCSEL MMF 550m DDM 0~70C

FEATURES

- Up to 1.25Gb/s Data Links
- Hot-Pluggable
- Duplex LC connector
- Up to 550m on 50/125µm MMF
- 850nm VCSEL laser transmitter
- Single +3.3V Power Supply
- Low power dissipation <1W typically
- Commercial operating temperature range 0°C to 70°C
- RoHS compliant and Lead Free

APPLICATIONS

- Metro/Access Networks
- 1.25 Gb/s 1000Base-SX Ethernet
- 1 × Fibre Channel
- Other Optical Links

DESCRIPTION

ATGBICS® Compatible JD063A-C Transceiver is a high-performance, cost-effective module which has a duplex LC optics interface. Standard AC coupled CML for high-speed signal and LVTTTL control and monitor signals. The receiver section uses a PIN receiver and the transmitter uses a 850 nm VCSEL laser, up to 8dB link budget ensure this module 1000Base Ethernet 550m application.

Absolute Maximum Ratings

Parameter	Symbol	Min.	Typical	Max.	Unit
Storage Temperature	T _s	-40		+85	°C
Supply Voltage	V _{CC}	-0.5		4	V
Relative Humidity	RH	0		85	%

Product Datasheet

Recommended Operating Environment:

Parameter	Symbol	Min.	Typical	Max.	Unit
Operating Temperature		0		+70	°C
Supply Voltage	V _{CC}	3.135		3.465	V
Supply Current	I _{CC}			300	mA
Inrush Current	I _{surge}			I _{CC} +30	mA
Maximum Power	P _{max}			1	W

Electrical Characteristics (T_{OP} = -40 to 85°C, V_{CC} = 3.135 to 3.465 Volts)

Parameter	Symbol	Min.	Typical	Max.	Unit	Notes
Transmitter Section:						
Input differential impedance	R _{in}	90	100	110	Ω	1
Single ended data input swing	V _{in PP}	250		1200	mVp-p	
Transmit Disable Voltage	V _D	V _{CC} – 1.3		V _{CC}	V	2
Transmit Enable Voltage	V _{EN}	V _{EE}		V _{EE} +0.8	V	
Transmit Disable Assert Time	T _{dessert}			10	us	
Receiver Section:						
Single ended data output swing	V _{out,p} p	250		800	mv	3
LOS Fault	V _{losfault}	V _{CC} – 0.5		V _{CC_host}	V	5
LOS Normal	V _{los norm}	V _{EE}		V _{EE} +0.5	V	5
Power Supply Rejection	PSR	100			mVpp	6

Notes:

1. AC coupled.
2. Or open circuit.
3. Into 100-ohm differential termination.
4. 20 – 80 %
5. LOS is LVTTTL. Logic 0 indicates normal operation; logic 1 indicates no signal detected.
6. All transceiver specifications are compliant with a power supply sinusoidal modulation of 20 Hz to 1.5MHz up to specified value applied through the power supply filtering network shown on page 23 of the Small Form-factor Pluggable (SFP) Transceiver Multi-Source Agreement (MSA), September 14, 2000.

Product Datasheet

Optical Parameters ($T_{OP} = -40$ to 85°C , $V_{CC} = 3.135$ to 3.465 Volts)

Parameter	Symbol	Min.	Typical	Max.	Unit	Note
Transmitter Section:						
Center Wavelength	λ_c	840	850	860	nm	
Spectral Width (RMS)	σ_{RMS}			0.85	nm	
Optical Output Power	P_{out}	-9		-3	dBm	1
Extinction Ratio	ER	9			dB	
Optical Rise/Fall Time	t_r / t_f			260	ps	2
Relative Intensity Noise	RIN			-120	dB/H z	
Output Eye Mask	Compliant with IEEE802.3 z (class 1 laser safety)					
Receiver Section:						
Optical Input Wavelength	λ_c	770		860	nm	
Receiver Overload	P_{ol}	0			dBm	4
RX Sensitivity	Sen			-17	dBm	4
RX_LOS Assert	LOS_A	-35			dBm	
RX_LOS De-assert	LOS_D			-18	dBm	
RX_LOS Hysteresis	LOS_H	0.5			dB	
General Specifications:						
Data Rate	BR		1.25		Gb/s	
Bit Error Rate	BER			10^{-12}		
Max. Supported Link Length on 50/125 μm MMF@1.25Gb/s	L_{MAX}		550		m	
Total System Budget	LB	8			dB	

Notes:

1. The optical power is launched into MMF.
2. 20-80%.
3. Jitter measurements taken using Agilent OMNIBERT 718 in accordance with GR-253.
4. Measured with PRBS 2^{7-1} at 10^{-12} BER

Product Datasheet

Pin Assignment

Diagram of Host Board Connector Block Pin Numbers and Name



Diagram of Host Board Connector Block Pin Numbers and Names

Product Datasheet

Pin Function Definitions

Pin No	Name	Function	Plug Seq	Notes
1	VeeT	Transmitter Ground	1	1
2	TX Fault	Transmitter Fault Indication	3	
3	TX Disable	Transmitter Disable	3	2
4	MOD-DEF2	Module Definition	2	3
5	MOD-DEF1	Module Definition 1	3	3
6	MOD-DEF0	Module Definition 0	3	3
7	Rate Select	Not Connected	3	4
8	LOS	Loss of Signal	3	5
9	VeeR	Receiver Ground	1	1
10	VeeR	Receiver Ground	1	1
11	VeeR	Receiver Ground		1
12	RD-	Inv. Received Data Out	3	6
13	RD+	Received Data Out	3	6
14	VeeR	Receiver Ground	3	1
15	VccR	Receiver Power	2	1
16	VccT	Transmitter Power	2	
17	VeeT	Transmitter Ground	1	
18	TD+	Transmit Data In	3	6
19	TD-	Inv. Transmit In	3	6
20	VeeT	Transmitter Ground	1	

Notes:

1. Circuit ground is internally isolated from chassis ground.
2. Laser output disabled on TDIS >2.0V or open, enabled on TDIS <0.8V.
3. Should be pulled up with 4.7k - 10 kohms on host board to a voltage between 2.0V and 3.6V. MOD_DEF (0) pulls line low to indicate module is plugged in.
4. Rate select is not used
5. LOS is open collector output. Should be pulled up with 4.7k – 10 kohms on host board to a voltage between 2.0V and 3.6V. Logic 0 indicates normal operation; logic 1 indicates loss of signal.
6. AC Coupled

SFP Module EEPROM Information and Management

The SFP modules implement the 2-wire serial communication protocol as defined in the SFP -8472. The serial ID information of the SFP modules can be accessed through the I²C interface at address A0h.

Product Datasheet

EEPROM Serial ID Memory Contents (A0h)

Data Address	Length (Byte)	Name of Length	Description and Contents
Base ID Fields			
0	1	Identifier	Type of Serial transceiver (03h=SFP)
1	1	Reserved	Extended identifier of type serial transceiver (04h)
2	1	Connector	Code of optical connector type (07=LC)
3-10	8	Transceiver	
11	1	Encoding	NRZ(03h)
12	1	BR, Nominal	Nominal baud rate, unit of 100Mbps
13-14	2	Reserved	(0000h)
15	1	Length(9um)	Link length supported for 9/125um fiber, units of 100m
16	1	Length(50um)	Link length supported for 50/125um fiber, units of 10m
17	1	Length(62.5um)	Link length supported for 62.5/125um fiber, units of 10m
18	1	Length(Copper)	Link length supported for copper, units of meters
19	1	Reserved	
20-35	16	Vendor Name	SFP vendor name: ATGBICS
36	1	Reserved	
37-39	3	Vendor OUI	SFP transceiver vendor OUI ID
40-55	16	Vendor PN	Part Number: "JD063A-C" (ASCII)
56-59	4	Vendor rev	Revision level for part number
60-62	3	Reserved	
63	1	CCID	Least significant byte of sum of data in address 0-62
Extended ID Fields			
64-65	2	Option	Indicates which optical SFP signals are implemented (001Ah = LOS, TX_FAULT, TX_DISABLE all supported)
66	1	BR, max	Upper bit rate margin, units of %
67	1	BR, min	Lower bit rate margin, units of %
68-83	16	Vendor SN	Serial number (ASCII)
84-91	8	Date code	Manufacturing date code
92-94	3	Reserved	
95	1	CCEX	Check code for the extended ID Fields (addresses 64 to 94)

Product Datasheet

Vendor Specific ID Fields

96-127	32	Readable	Vendor specific date, read only
128-255	128	Reserved	Reserved for SFF-8079

Regulatory Compliance

The GLX-SX-MMD-C complies with international Electromagnetic Compatibility (EMC) and international safety requirements and standards (see details in Table following).

Electrostatic Discharge (ESD) to the Electrical Pins	MIL-STD-883E Method 3015.7	Class 1(>1000 V)
Electrostatic Discharge (ESD) to the Duplex LC Receptacle	IEC 61000-4-2 GR-1089-CORE	Compatible with standards
Electromagnetic Interference (EMI)	FCC Part 15 Class B EN55022 Class B (CISPR 22B) VCCI Class B	Compatible with standards
Laser Eye Safety	FDA 21CFR 1040.10 and 1040.11 EN60950, EN (IEC) 60825-1,2	Compatible with Class 1 laser product.

Recommended Circuit

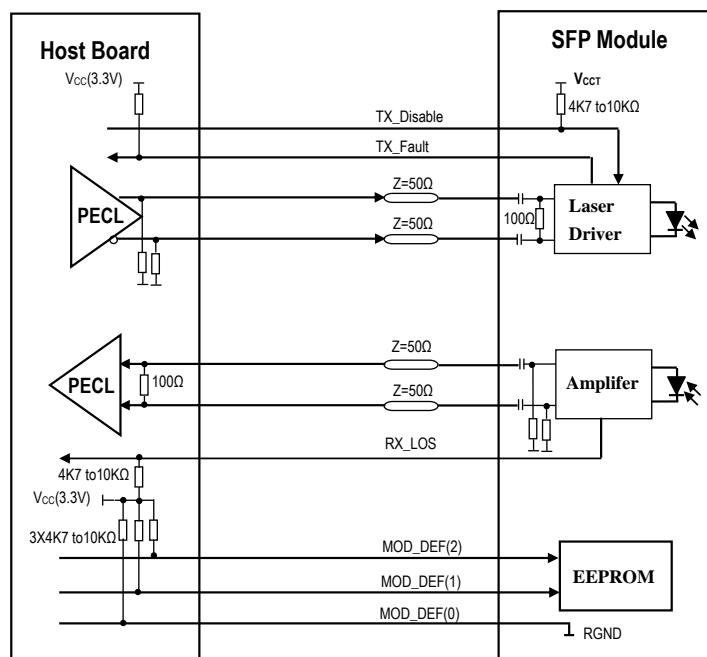

SFP Host Recommended Circuit

Product Datasheet

Mechanical Dimensions



Mechanical Drawing