

## MOTOR SPECIFICATIONS

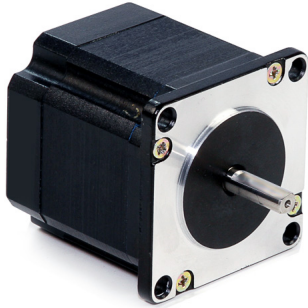

## DIMENSIONS

Part Number	<b>WO-5718X-15P</b>
Step Angle	1.8°
Frame Size	NEMA 23
Body Length (Dim. A)	1.74 in (44.2 mm)
Current	4.2 Amps/Phase
Holding Torque	100 oz-in (0.71 Nm)
Resistance	0.3 Ohms/Phase
Rotor Inertia	0.7 oz-in <sup>2</sup>
Number of Leads	4
Connection	Parallel
Weight	1.05 lbs (0.48 kg)

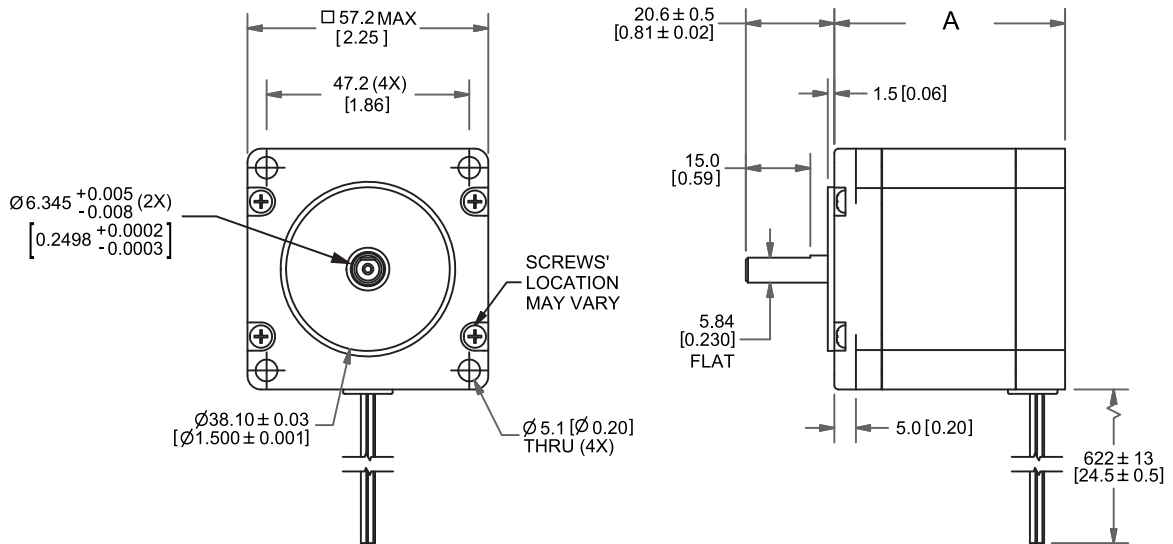

## PERFORMANCE CURVE

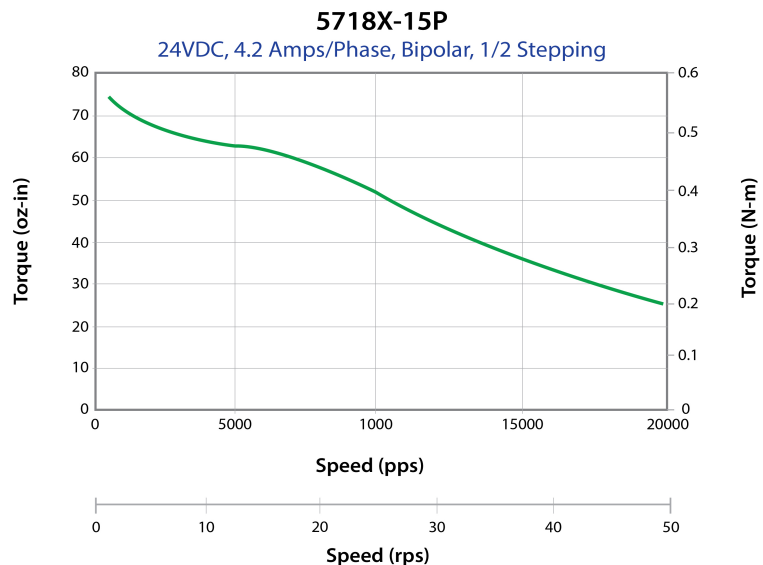

## OPERATING SPECIFICATIONS

Radial Play	0.001" max @ 1 lbs load
End Play	0.003" max @ 2 lbs load
Shaft Run Out	0.002" TIR
Concentricity of Mounting Pilot to Shaft	0.003" TIR
Perpendicularity of Shaft to Mounting Face	0.003" TIR
Max Axial Load	13 lbs
Maximum Case Temperature	80 C
Ambient Temperature	-20° to 50° C
Storage Temperature	-20° to 100° C
Humidity Range	85% or less, non-condensing
Magnet Wire Insulation	Class B 130° C
Insulation Resistance	100MΩ at 500 VDC
Dielectric Strength	500 VAC for 1 minute

## WIRING TABLE

COLOR	FUNCTION
Red	A+ Phase
Blue	A- Phase
Green	B + Phase
Black	B- Phase

## OPERATION & USAGE TIPS

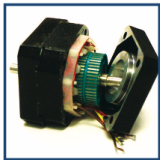

**Do not** disassemble motors; a significant reduction in motor performance will occur.

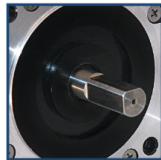

**Do not** machine shafts; this will have a negative effect on shaft run out and perpendicularity.

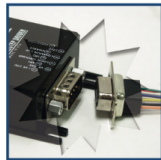

**Do not** disconnect motor from drive while in operation.

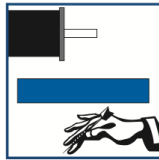

**Do not** use holding torque/detent torque of motor as a fail safe brake.

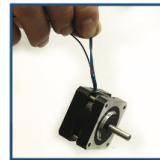

**Do not** hold motor by lead wires.



**Do not** exceed the rated current; this will burn the motor.

FAILURE TO COMPLY WITH THESE RECOMMENDATIONS WILL VOID ALL WARRANTY TERMS

## RECOMMENDED



Microstepping Driver  
**R701P-RO**

# Motion Control, **Solved.**

## MOTOR ENGINEERING & MANUFACTURING



Optimized  
For Your  
Application



Quick  
Prototype  
Turnaround



Small Batch  
to OEM Volume  
Production



US Based  
Support &  
Manufacturing