

THIS DRAWING IS UNPUBLISHED. RELEASED FOR PUBLICATION APRIL, 2004.
 © COPYRIGHT 2004 By - ALL RIGHTS RESERVED.

LOC	DIST	REVISIONS					
		P	LTR	DESCRIPTION	DATE	DWN	APVD
E	B	C1		REVISED PER ECO-11-005033	01APR11	RK	HMR

NOTES:

- 1 SINGLE PACK IN ACCORDANCE WITH SPEC 107-3275
- 2 100 BULK PACK IN ACCORDANCE WITH SPEC 107-3275
- 3 GOLD PLATING
- 4 PASSIVATED
- 5 WHITE BRONZE PLATING
- 6 PLATING AS PER BODY, EXCEPT FOR PASSIVATED WHICH IS NICKEL PLATED
- 7 HAND TOOL 9-1478240-0
- 8 DIE SET 9-1478248-0
- 9 ELECTRICAL CHARACTERISTICS
 - FREQUENCY RANGE:
 - BRASS BODY: DC - 6 GHz
 - STAINLESS STEAL (PASSIVATED): DC - 12.4 GHz
 - STAINLESS STEAL (GOLD): DC - 18 GHz
 - NOMINAL IMPEDANCE: 50 Ohm
 - INSULATION RESISTANCE: 1000 MOhm
 - WORKING VOLTAGE: 250 Volts RMS at Sea Level
 - DIELECTRIC WITHSTAND VOLTAGE: 750 Volts RMS Max
 - CONTACT RESISTANCE:
 - CENTRE CONTACT: 6.00 mOhm Max
 - OUTER CONTACT: 1.00 mOhm Max
 - VSWR @ 4GHz: 1.35:1
 - INSERTION LOSS dB @ x 1.5 GHz: 0.30 Max
- 10 MECHANICAL CHARACTERISTICS
 - COUPLING NUT RETENTION FORCE: N/A
 - CABLE RETENTION FORCE:
 - RG174A/U, 188A/U, 316/U, URM95: 267N Min
 - CLAMP NUT RECOMMENDED TORQUE: 0.6N
 - MOUNT NUT RECOMMENDED TORQUE: 0.75N
 - DURABILITY: 500 Cycles Min
- 11 ENVIRONMENTAL CHARACTERISTICS
 - OPERATING TEMPERATURE: -65 to +165 DegC
- 12 FOR TECHNICAL DATA REFER TO YOUR LOCAL TE CONNECTIVITY SALES OFFICE
- 13 ALL DIMENSIONS ARE NOMINAL FOR REFERENCE ONLY UNLESS OTHERWISE STATED

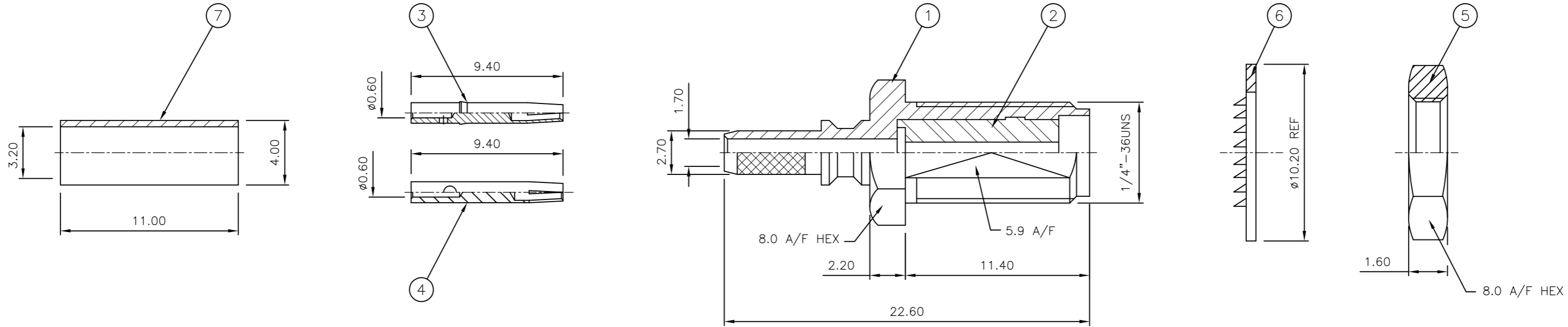

QTY	QTY	QTY	QTY	QTY	QTY	QTY	QTY	QTY	MATERIAL	DESCRIPTION	ITEM
1	1	1	1	1	1	1	1	1	BRASS	CRIMP FERRULE	7
1	1	1	1	1	1	1	1	1	STAINLESS STEEL	LOCKWASHER	6
1	1	-	-	-	-	-	-	-	BRASS	HEX NUT	5
-	-	1	1	-	-	-	-	-	BRASS	HEX NUT	5
-	-	-	-	1	1	1	1	1	STAINLESS STEEL	HEX NUT	5
-	-	-	-	1	1	1	1	1	BERYLLIUM COPPER	CENTRE SOCKET	4
1	1	1	1	-	-	-	-	-	BERYLLIUM COPPER	CENTRE SOCKET	3
1	1	1	1	1	1	1	1	1	PTFE	INSULATOR	2
1	1	-	-	-	-	-	-	-	BRASS	BODY	1
-	-	1	1	-	-	-	-	-	BRASS	BODY	1
-	-	-	-	1	1	-	-	-	STAINLESS STEEL	BODY	1
-	-	-	-	-	-	1	1	1	STAINLESS STEEL	BODY	1
4--1	4--0	3--1	3--0	2--1	2--0	1--1	1--0		MATERIAL	DESCRIPTION	ITEM
△	△	△	△	△	△	△	△				

THIS DRAWING IS A CONTROLLED DOCUMENT.		DWN R.SMITH 05FEB04		
DIMENSIONS: mm		CHK S.PARLOW 05FEB04		
TOLERANCES UNLESS OTHERWISE SPECIFIED		APVD F.WHEELER-KING 05FEB04	NAME SMA BULKHEAD JACK NON CAPTIVE SOLDER CONTACT CRIMP ATTACHMENT	
0 PLC ± 1 PLC ± 2 PLC ± 3 PLC ± 4 PLC ± ANGLES ±		PRODUCT SPEC	RG174A/U, 188A/U, 316/U, KX3B, KX22A, URM95	
MATERIAL SEE TABLE		FINISH -	SIZE A2	CAGE CODE 00779
		WEIGHT -	DRAWING NO C=1478955	RESTRICTED TO -
		CUSTOMER DRAWING	SCALE NTS	SHEET 1 of 2
			REV C1	

1478955

THIS DRAWING IS UNPUBLISHED. RELEASED FOR PUBLICATION APRIL , 2004.
 © COPYRIGHT 2004 By - ALL RIGHTS RESERVED.

LOC		DIST		REVISIONS			
P	LTR	DESCRIPTION	DATE	DWN	APVD		
-	-	SEE SHEET 1	-	-	-		

COMPONENTS

MAIN BODY (ITEM 1,2)

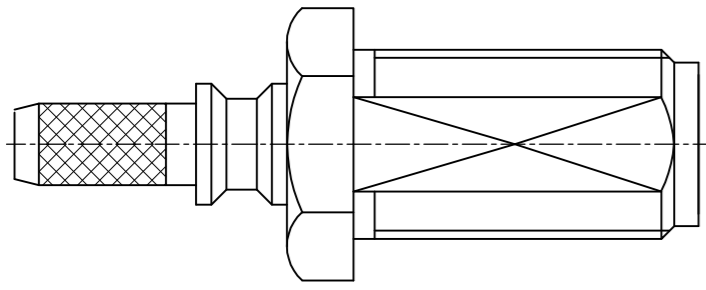

CENTRE SOCKET (ITEM 3,4)

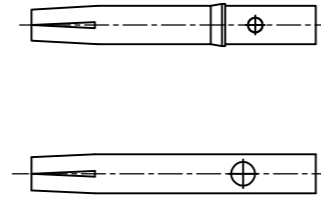

NEX NUT (ITEM 5)

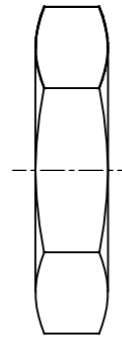

LOCKWASHER (ITEM 6)

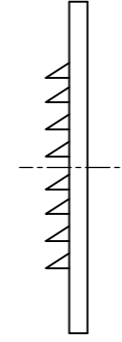

CRIMP FERRULE (ITEM 7)

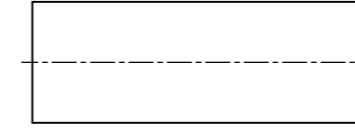

ASSEMBLY INSTRUCTIONS

RG174A/U, 188A/U, 316/U, KX3B, KX22A, URM95

STEP 1

- IF USING HEATSHRINK SLIDE OVER CABLE (HEATSHRINK NOT SUPPLIED AND USED AT CUSTOMER DISCRETION)
- SLIDE METAL CRIMP FERRULE OVER CABLE

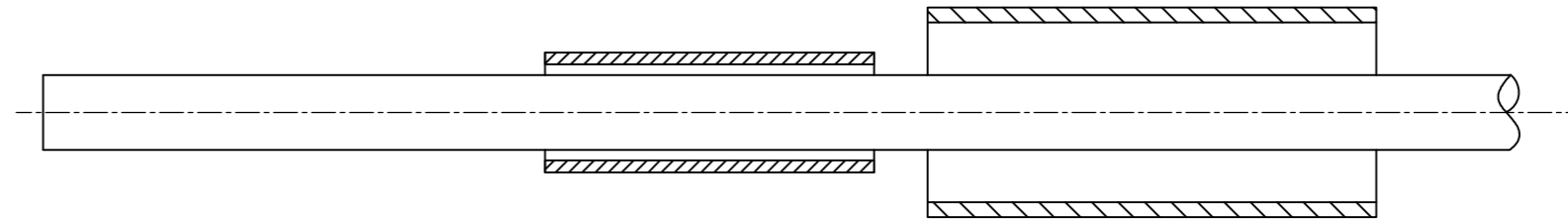

STEP 2

- STRIP CABLE TO DIMENSIONS AS SHOWN

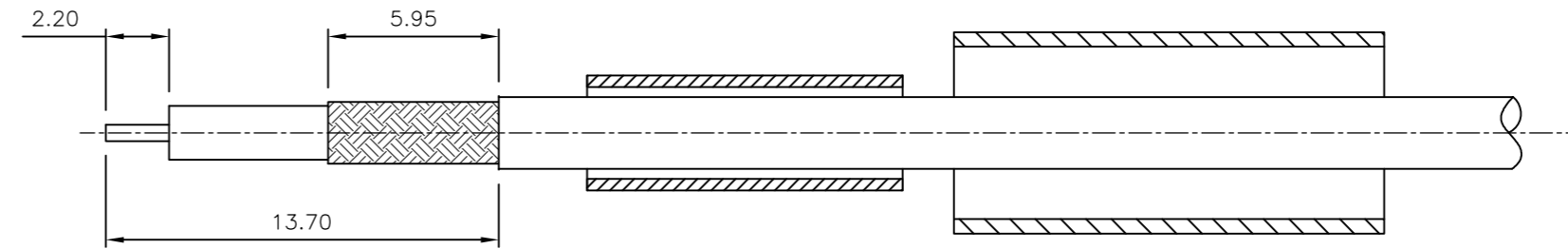

STEP 3

- TIN CENTRE CONTACT
- FIT CONTACT OVER CONDUCTOR
- SOLDER CONTACT (ITEM 3 OR 4 AS SUPPLIED) TO TINNED CENTRE CONDUCT, DO NOT OVER HEAT

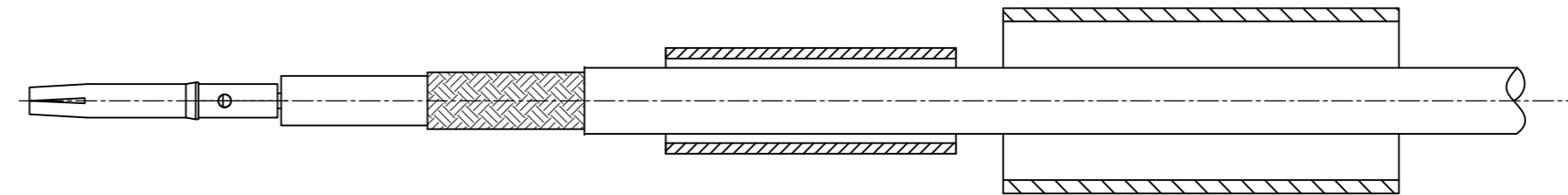

STEP 4

- PRESS SUB-ASSEMBLY INTO BODY UNTIL CONTACT IS FULLY LOCATED
- ENSURE THAT KNURLED HOUSING INSERTS BETWEEN THE DIELECTRIC AND CABLE BRAID

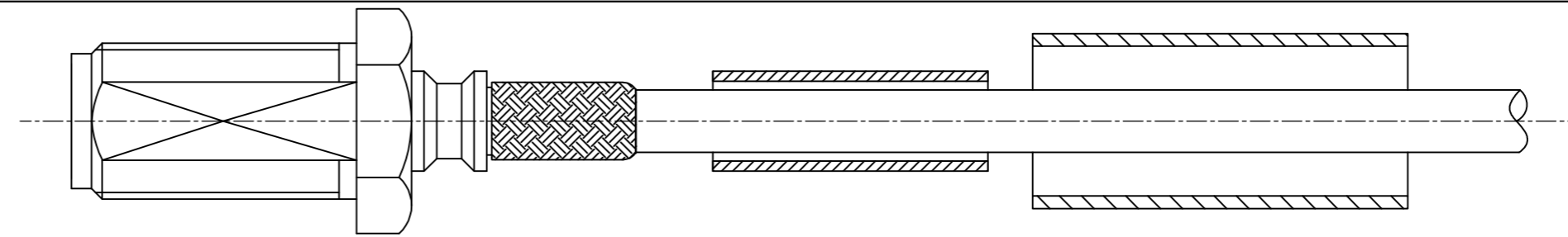

STEP 5

- SLIDE CRIMP FERRULE ALONG THE CABLE UNTIL IT BUTTS AGAINST THE BODY HOUSING
- CRIMP USING TOOL AS NOTED ON PAGE 1
- CRIMP DIMENSION AS SHOWN

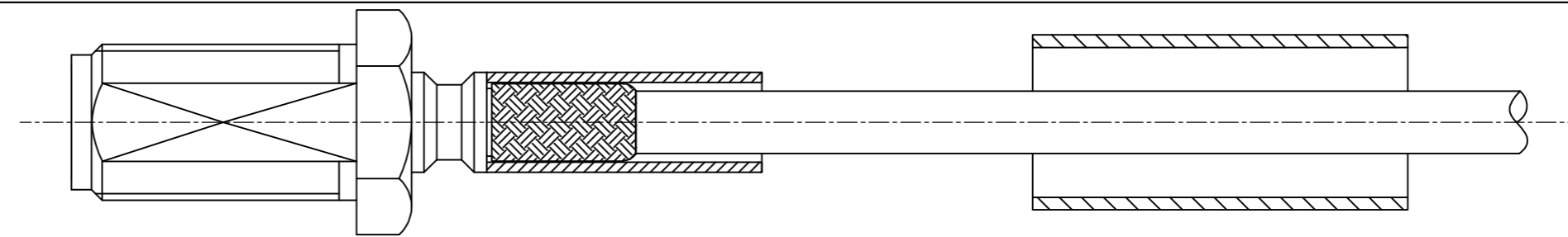

RECOMMENDED CRIMP SLEEVE A/F HEX

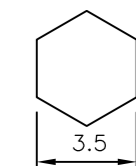

STEP 5

- IF USING HEATSHRINK PLACE OVER CONNECTOR AS SHOWN AND APPLY
- FOR BULKHEAD MOUNTING PREPARE HOLE AS SHOWN
- USE LOCKWASHER (ITEM 6) AND HEX NUT (ITEM 5) TO SECURE CONNECTOR

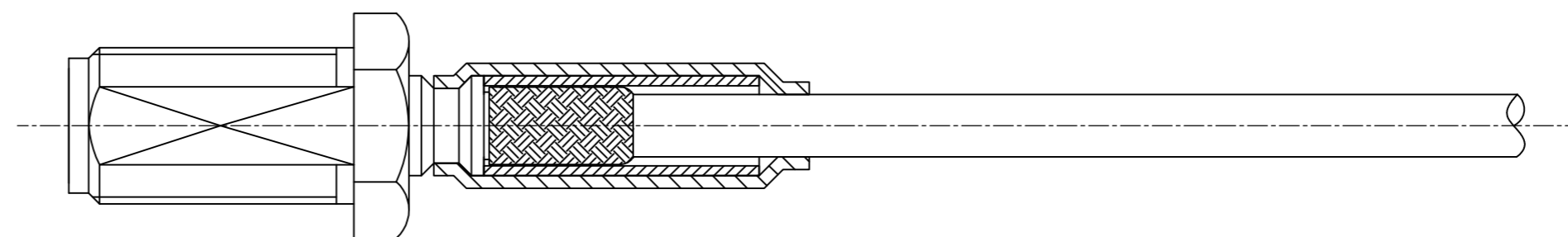
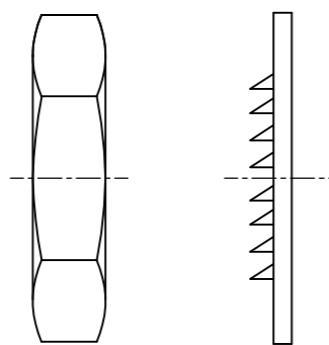

RECOMMENDED MOUNTING HOLE DIM'S

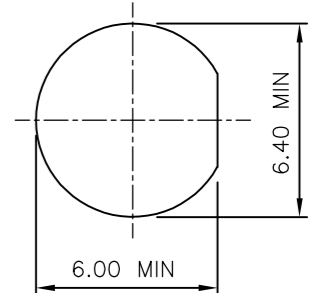

THIS DRAWING IS A CONTROLLED DOCUMENT.

DWN R.SMITH 05FEB04

CHK S.PARLOW 05FEB04

APVD F.WHEELER-KING 05FEB04

PRODUCT SPEC

108-3460

APPLICATION SPEC

411-3276

WEIGHT -

CUSTOMER DRAWING

STE TE Connectivity		NAME	
SMA BULKHEAD JACK NON CAPTIVE SOLDER CONTACT CRIMP ATTACHMENT		RG174A/U, 188A/U, 316/U, KX3B, KX22A, URM95	
SIZE	CAGE CODE	DRAWING NO	RESTRICTED TO
A2	00779	C=1478955	-
SCALE	SHEET	REV	
NTS	2 OF 2	C1	

DIMENSIONS:	TOLERANCES UNLESS OTHERWISE SPECIFIED:
mm	
	0 PLC ± -
	1 PLC ± -
	2 PLC ± -
	3 PLC ± -
	4 PLC ± -
	ANGLES ± -
MATERIAL	FINISH
SEE TABLE	-