

Advanced Load Management Switch

FPF1504 / FPF1504L

Description

The FPF1504/FPF1504L are low- R_{DS} P-channel MOSFET load switches of the IntelliMAX™ family. Integrated slew-rate control prevents excessive inrush current from the supply rails with capacitive loads common in power applications. In addition, the FPF1504/FPF1504L feature output discharge capability.

The input voltage range operates from 1.0 V to 3.6 V to fulfill today's mobile device supply requirements. Switch control is by a logic input (ON pin) capable of interfacing directly with low-voltage CMOS control signals and GPIOs in embedded processors.

Features

- 1.0 V to 3.6 V Input Voltage Operating Range
- Typical $R_{DS(ON)}$:
 - ◆ 15 mΩ at $V_{IN} = 3.3$ V
 - ◆ 20 mΩ at $V_{IN} = 1.8$ V
 - ◆ 40 mΩ at $V_{IN} = 1.0$ V
- Slew Rate Control
- Output Discharge Function
- Low <1 μA Quiescent Current at $V_{ON} = V_{IN}$
- ESD Protected: 4000 V HBM, 2000 V CDM
- GPIO/CMOS-Compatible Enable Circuitry
- Active HIGH and active LOW versions

Applications

- Mobile Devices and Smart Phones
- Portable Media Devices
- Digital Cameras
- Advanced Notebook, UMPC, and MID
- Portable Medical Devices
- GPS and Navigation Equipment

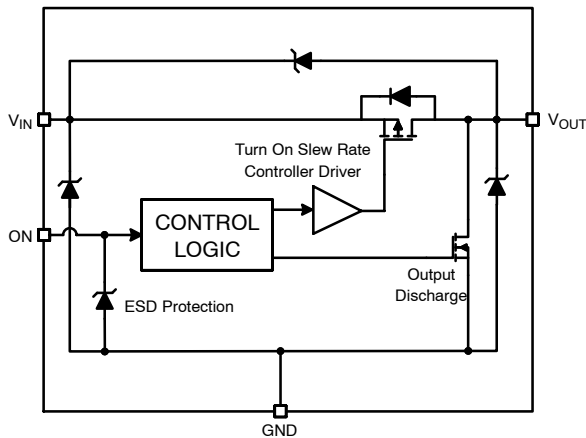

Figure 1. Block Diagram



ON Semiconductor®

www.onsemi.com



WLCSP4
CASE 567RH

MARKING DIAGRAM

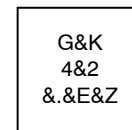

- G = 1st Digit of 2 Digit Device ID Mark
- &K = 2-Digits Lot Run Traceability Code
- 4 = 2nd Digit of 2 Digit Device ID Mark
- &2 = 2-digit Date Code Format
- &. = Pin 1 Identifier
- &E = Space Designator
- &Z = Assembly Plant Code

ORDERING INFORMATION

See detailed ordering and shipping information in the package dimensions section on page 2 of this data sheet.

FPF1504 / FPF1504L

ORDERING INFORMATION

| Part Number | Top Mark | Switch (Typical) At 1.8 V _{IN} | Input Buffer | Output Discharge | ON Pin Activity | Package |
|--------------|----------|---|--------------|------------------|-----------------|--|
| FPF1504UCX | G4 | 20 mΩ | CMOS | YES | Active HIGH | 4-Ball, WLCSP, 0.5 mm Pitch |
| FPF1504BUCX | G4 | 20 mΩ | CMOS | YES | Active HIGH | 4-Ball, WLCSP with Backside Laminate, 0.5 mm Pitch |
| FPF1504LUCX | GZ | 20 mΩ | CMOS | YES | Active LOW | 4-Ball, WLCSP, 0.5 mm Pitch |
| FPF1504LBUCX | GZ | 20 mΩ | CMOS | YES | Active LOW | 4-Ball, WLCSP with Backside Laminate, 0.5 mm Pitch |

Application Diagram

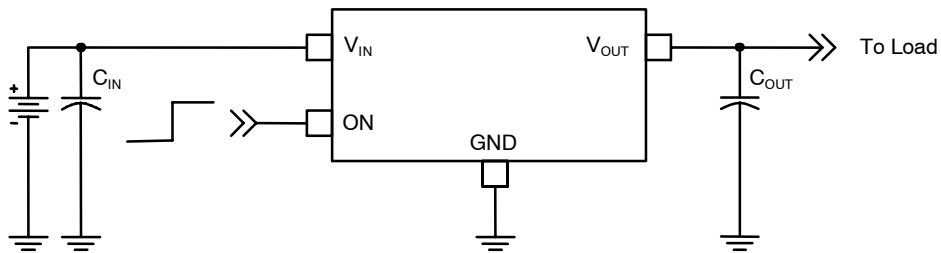

- NOTES: 1. C_{IN} = 1 μF, X5R, 0603, for example Murata GRM185R60J105KE26.
2. C_{OUT} = 1 μF, X5R, 0805, for example Murata GRM216R61A105KA01.

Figure 2. Typical Application

Pin Configurations

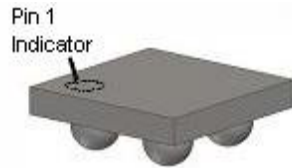

Figure 3. 1 x 1 mm WLCSP Bumps Facing Down

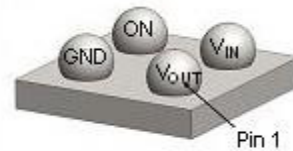

Figure 4. 1 x 1 mm WLCSP Bumps Facing Up

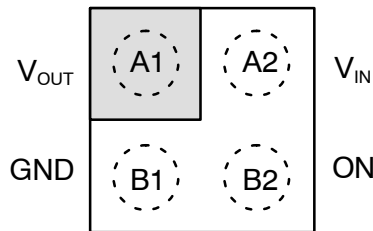

Figure 5. Pin Assignments (Top View)

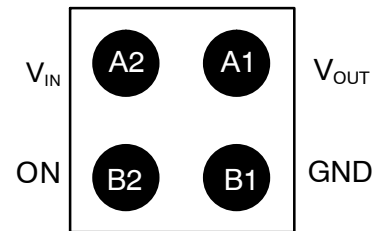

Figure 6. Pin Assignments (Bottom View)

FPF1504 / FPF1504L

PIN DEFINITIONS

| Pin # | Name | Description |
|-------|------------------|---|
| A1 | V _{OUT} | Switch Output |
| A2 | V _{IN} | Supply Input; Input to the Power Switch |
| B1 | GND | Ground |
| B2 | ON | ON/OFF Control |

ABSOLUTE MAXIMUM RATINGS

| Symbol | Parameter | Min. | Max. | Unit |
|------------------|---|-----------------------------------|------|------|
| V _{IN} | V _{IN} , V _{OUT} , V _{ON} to GND | -0.3 | 4.0 | V |
| I _{SW} | Maximum Continuous Switch Current | | 1.5 | A |
| P _D | Power Dissipation at T _A = 25°C | | 1.0 | W |
| T _{STG} | Storage Junction Temperature | -65 | +150 | °C |
| T _A | Operating Temperature Range | -40 | +85 | °C |
| θ _{JA} | Thermal Resistance, Junction-to-Ambient | 1S2P with 1 Thermal Via | 95 | °C/W |
| | | 1S2P without Thermal Via | 187 | |
| ESD | Electrostatic Discharge Capability | Human Body Model, JESD22-A114 | 4 | kV |
| | | Charged Device Model, JESD22-C101 | 2 | |

Stresses exceeding those listed in the Maximum Ratings table may damage the device. If any of these limits are exceeded, device functionality should not be assumed, damage may occur and reliability may be affected.

RECOMMENDED OPERATING CONDITIONS

| Symbol | Parameter | Min. | Max. | Unit |
|-----------------|-------------------------------|------|------|------|
| V _{IN} | Supply Voltage | 1.0 | 3.6 | V |
| T _A | Ambient Operating Temperature | -40 | +85 | °C |

Functional operation above the stresses listed in the Recommended Operating Ranges is not implied. Extended exposure to stresses beyond the Recommended Operating Ranges limits may affect device reliability.

FPF1504 / FPF1504L

ELECTRICAL CHARACTERISTICS

Unless otherwise noted, $V_{IN} = 1.0$ to 3.6 V, $T_A = -40$ to $+85^\circ\text{C}$; Typical Values are at $V_{IN} = 3.3$ V and $T_A = 25^\circ\text{C}$.

| Symbol | Parameter | Conditions | Min. | Typ. | Max. | Units |
|--------|-----------|------------|------|------|------|-------|
|--------|-----------|------------|------|------|------|-------|

BASIC OPERATION

| | | | | | | | |
|---------------|---------------------------------------|---|---|-----|------|-----|------------------|
| V_{IN} | Supply Voltage | | | 1.0 | | 3.6 | V |
| $I_{Q(OFF)}$ | Off Supply Current | FPF1504 | $V_{ON} = \text{GND}, V_{OUT} = \text{Open}$ | | 0.25 | | μA |
| | | FPF1504L | $V_{ON} = V_{IN}, V_{OUT} = \text{Open}$ | | 0.3 | | |
| $I_{SD(OFF)}$ | Off Switch Current | FPF1504 | $V_{ON} = \text{GND}, V_{OUT} = \text{GND}$ | | 0.25 | | |
| | | FPF1504L | $V_{ON} = V_{IN}, V_{OUT} = \text{GND}$ | | 0.3 | | |
| I_Q | Quiescent Current | FPF1504 | $I_{OUT} = 0$ mA, $V_{IN} = 3.6$ V, $V_{ON} = V_{IN}$ | | 0.08 | | |
| | | | $I_{OUT} = 0$ mA, $V_{ON} = V_{IH(MIN)}$ | | 0.75 | | |
| | | FPF1504L | $I_{OUT} = 0$ mA, $V_{IN} = 3.6$ V, $V_{ON} = \text{GND}$ | | 0.08 | | |
| | | | $I_{OUT} = 0$ mA, $V_{ON} = V_{IL(MAX)}$ | | 0.95 | | |
| R_{ON} | On Resistance | $V_{IN} = 3.3$ V, $I_{OUT} = 200$ mA, $T_A = 25^\circ\text{C}$ | | | 15 | 30 | $\text{m}\Omega$ |
| | | $V_{IN} = 1.8$ V, $I_{OUT} = 200$ mA, $T_A = 25^\circ\text{C}$ | | | 20 | 40 | |
| | | $V_{IN} = 1.5$ V, $I_{OUT} = 200$ mA, $T_A = 25^\circ\text{C}$ | | | 30 | | |
| | | $V_{IN} = 1.0$ V, $I_{OUT} = 200$ mA, $T_A = 25^\circ\text{C}$ | | | 40 | 80 | |
| | | $V_{IN} = 1.8$ V, $I_{OUT} = 200$ mA, $T_A = 85^\circ\text{C}$ (Note 3) | | | 35 | 50 | |
| R_{PD} | Output Discharge Pull-Down Resistance | $V_{ON} = 0$ V or V_{IN} , $I_{OUT} = -20$ mA | | | 65 | 95 | Ω |
| V_{IH} | On Input Logic High Voltage | FPF1504 | | 0.8 | | | V |
| V_{IL} | On Input Logic Low Voltage | FPF1504 | | | | 0.3 | |
| I_{ON} | On Input Leakage | $V_{ON} = V_{IN}$ or GND | | | | 1 | μA |

DYNAMIC CHARACTERISTICS

| | | | | | | | | | |
|------------|------------------------------|----------|---|--|-----|-----|---------------|----|---------------|
| t_{DON} | Turn-On Delay (Note 4) | FPF1504 | $R_L = 10$ Ω , $C_L = 0.1$ μF , $V_{IN} = 3.3$ V, $T_A = 25^\circ\text{C}$ | | 80 | | μs | | |
| t_R | V_{OUT} Rise Time (Note 4) | FPF1504 | | | 130 | | | | |
| t_{ON} | Turn-On Time (Note 4) | FPF1504 | | | 210 | | | | |
| t_{DON} | Turn-On Delay (Note 4) | FPF1504 | $R_L = 500$ Ω , $C_L = 0.1$ μF , $V_{IN} = 3.3$ V, $T_A = 25^\circ\text{C}$ | | 70 | 100 | μs | | |
| | | FPF1504L | | | 95 | | | | |
| t_R | V_{OUT} Rise Time (Note 4) | FPF1504 | | | 110 | 150 | | | |
| | | FPF1504L | | | 115 | | | | |
| t_{ON} | Turn-On Time (Note 4) | FPF1504 | | | 180 | 250 | | | |
| | | FPF1504L | | | 210 | | | | |
| t_{DOFF} | Turn-Off Delay (Note 4) | FPF1504 | | $R_L = 10$ Ω , $C_L = 0.1$ μF , $V_{IN} = 3.3$ V, $T_A = 25^\circ\text{C}$ | | 25 | | 30 | μs |
| t_F | V_{OUT} Fall Time (Note 4) | FPF1504 | | | | 2 | | | |
| t_{OFF} | Turn-Off Time (Note 4) | FPF1504 | | | 27 | | | | |

FPF1504 / FPF1504L

ELECTRICAL CHARACTERISTICS (continued)

Unless otherwise noted, $V_{IN} = 1.0$ to 3.6 V, $T_A = -40$ to $+85^\circ\text{C}$; Typical Values are at $V_{IN} = 3.3$ V and $T_A = 25^\circ\text{C}$.

| Symbol | Parameter | Conditions | Min. | Typ. | Max. | Units |
|--------|-----------|------------|------|------|------|-------|
|--------|-----------|------------|------|------|------|-------|

DYNAMIC CHARACTERISTICS

| Symbol | Parameter | FPF1504 | Conditions | Min. | Typ. | Max. | Units |
|-----------|------------------------------|------------|------------|-------------------------|----------|---|-------|
| | | t_{DOFF} | | Turn-Off Delay (Note 4) | FPF1504L | $R_L = 500 \Omega, C_L = 0.1 \mu\text{F}, V_{IN} = 3.3 \text{ V}, T_A = 25^\circ\text{C}$ | |
| t_F | V_{OUT} Fall Time (Note 4) | FPF1504 | | | 12 | | |
| | | FPF1504L | | | 14 | | |
| t_{OFF} | Turn-Off Time (Note 4) | FPF1504 | | | 37 | | |
| | | FPF1504L | | | 16 | | |

Product parametric performance is indicated in the Electrical Characteristics for the listed test conditions, unless otherwise noted. Product performance may not be indicated by the Electrical Characteristics if operated under different conditions.

3. This parameter is guaranteed by design and characterization; not production tested.

4. $t_{DON}/t_{DOFF}/t_R/t_F$ are defined in Figure 7.

5. Output discharge path is enabled during off.

Timing Diagram – FPF1504

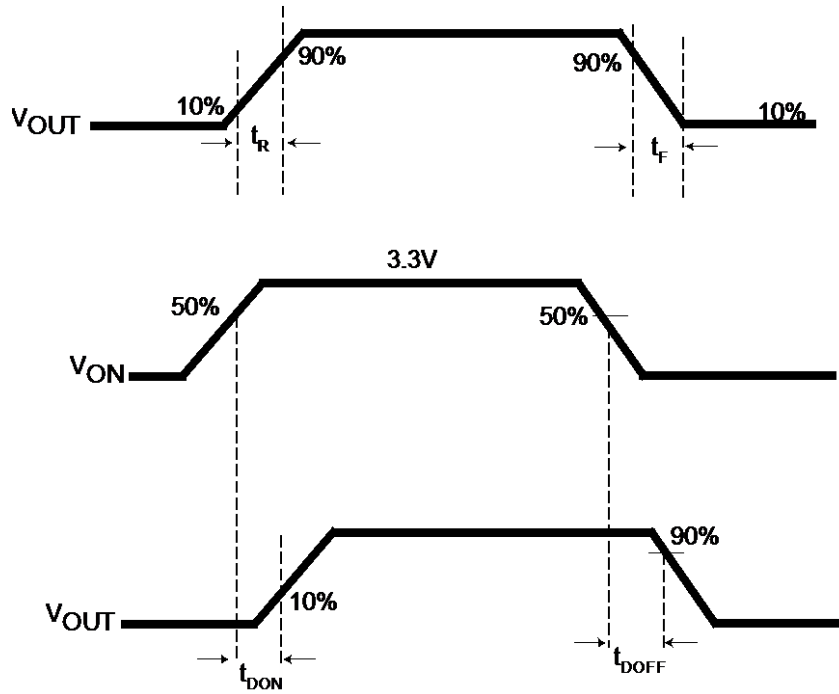

- NOTES: 6. $t_{ON} = t_R + t_{DON}$.
7. $t_{OFF} = t_F + t_{DOFF}$.

Figure 7. Timing Diagram for FPF1504

TYPICAL PERFORMANCE CHARACTERISTICS FOR FPF1504

Applicable to active high version only.

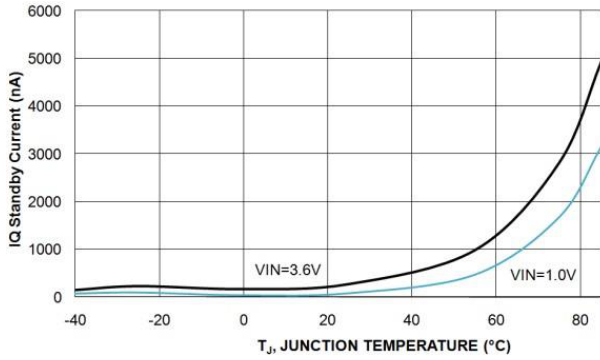

Figure 1. Shutdown Current vs. Temperature

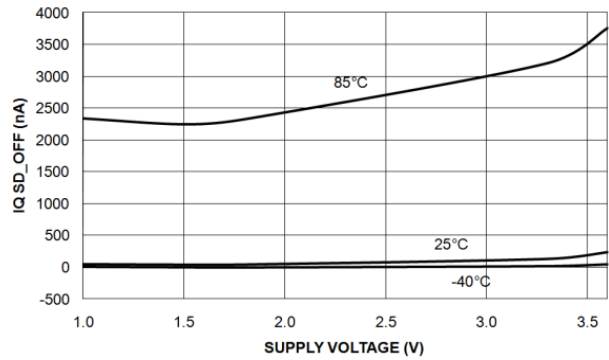

Figure 2. Shutdown Current vs. Supply Voltage

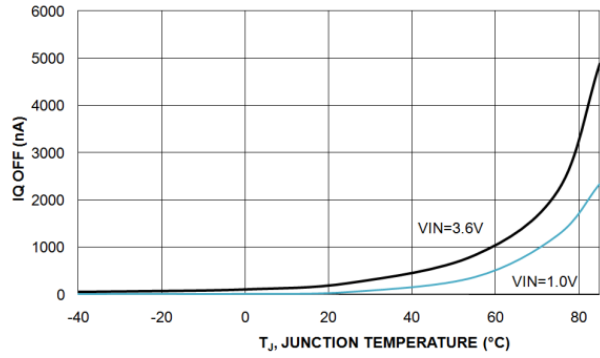

Figure 3. Off Supply Current vs. Temperature

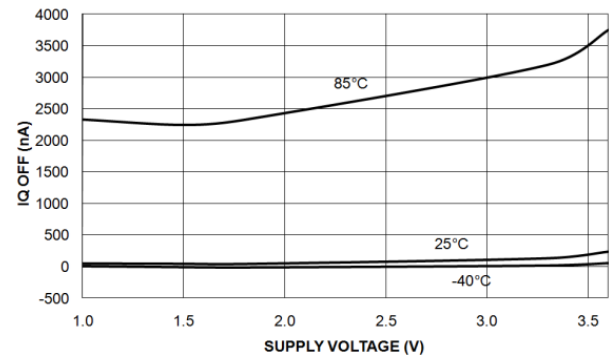

Figure 4. Off Supply Current vs. Supply Voltage

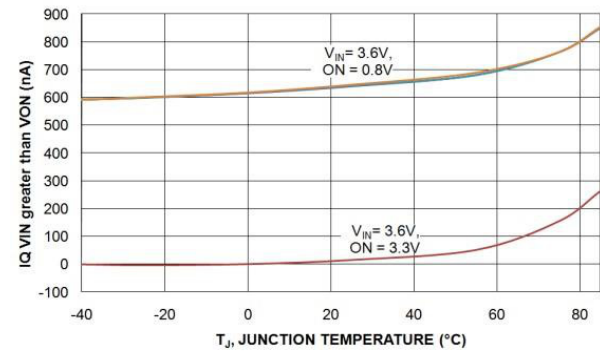

Figure 5. Quiescent Current vs. Temperature

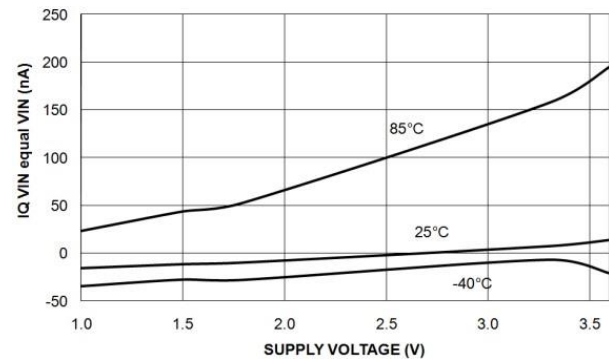

Figure 6. Quiescent Current vs. Supply Voltage
($V_{ON} = V_{IN}$)

PPF1504 / PPF1504L

TYPICAL PERFORMANCE CHARACTERISTICS FOR PPF1504

Applicable to active high version only.

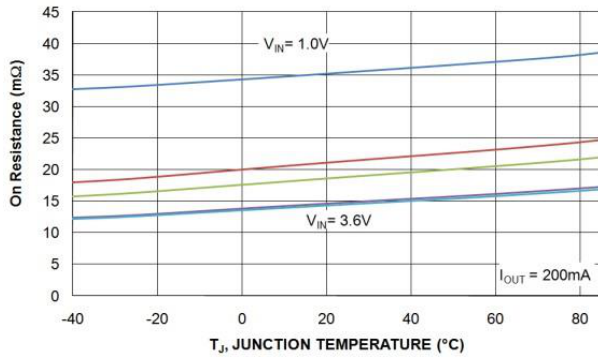

Figure 7. R_{ON} vs. Temperature

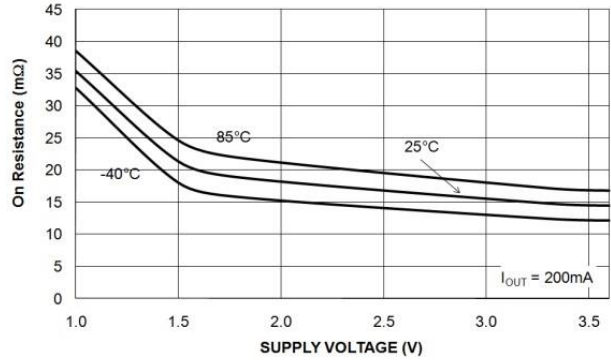

Figure 8. R_{ON} vs. Temperature

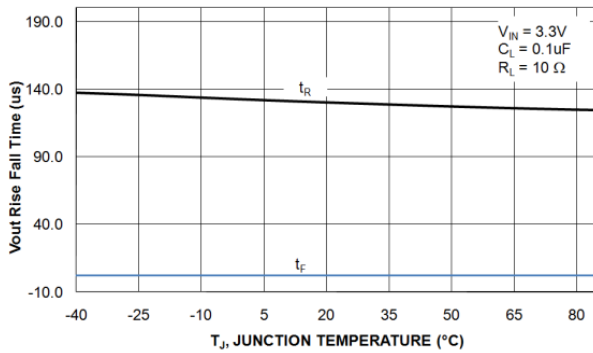

Figure 9. V_{OUT} Rise/Fall Times vs. Temperature ($R_L = 10\Omega$)

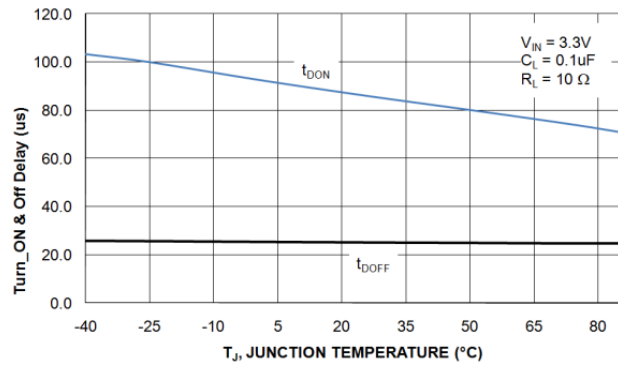

Figure 10. V_{OUT} Turn-On/Turn-Off Delays vs. Temperature ($R_L = 10\Omega$)

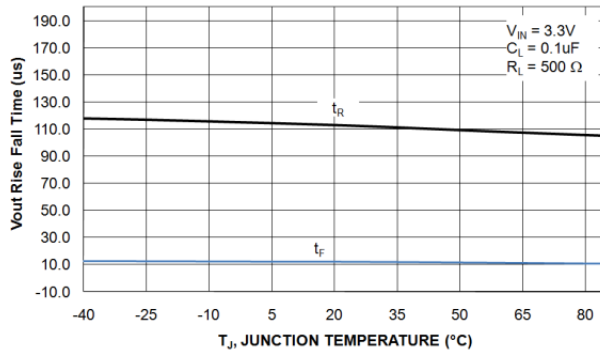

Figure 11. V_{OUT} Rise/Fall Time vs. Temperature ($R_L = 500\Omega$)

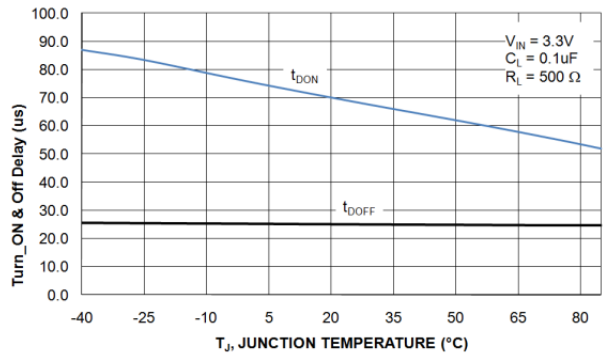

Figure 12. V_{OUT} Turn-On/Turn-Off Delays vs. Temperature ($R_L = 500\Omega$)

TYPICAL PERFORMANCE CHARACTERISTICS FOR FPF1504

Applicable to active high version only.

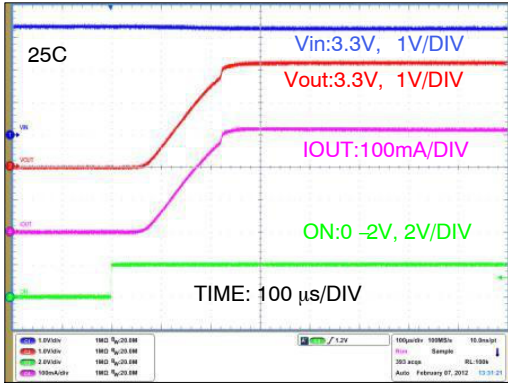

Figure 13. Turn-On Response
 $(V_{IN} = 3.3\text{ V}, C_{OUT} = 0.1\ \mu\text{F}, R_L = 10\ \Omega)$

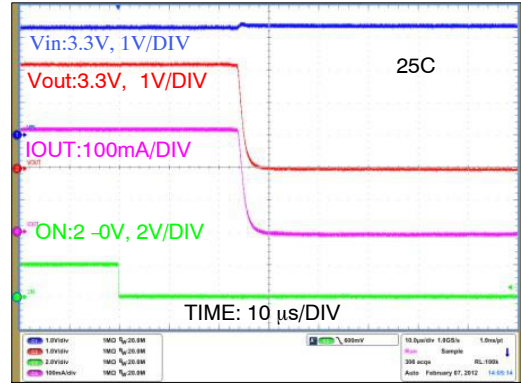

Figure 14. Turn-Off Response
 $(V_{IN} = 3.3\text{ V}, C_{OUT} = 0.1\ \mu\text{F}, R_L = 10\ \Omega)$

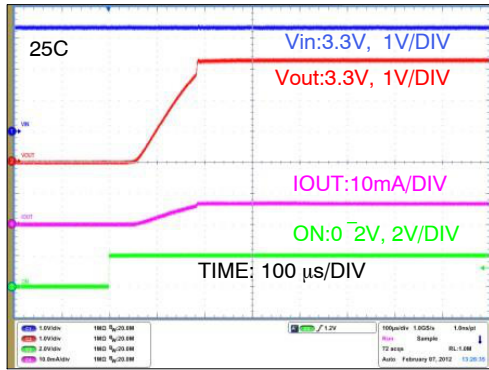

Figure 15. Turn-On Response
 $(V_{IN} = 3.3\text{ V}, C_{OUT} = 0.1\ \mu\text{F}, R_L = 500\ \Omega)$

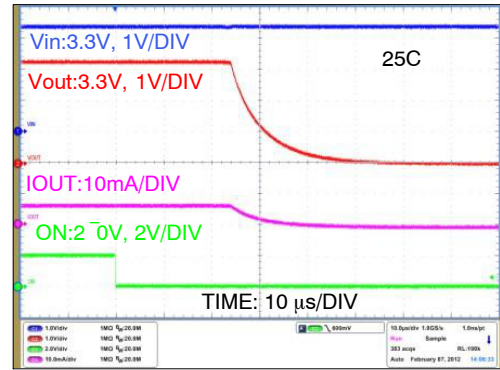

Figure 16. Turn-Off Response
 $(V_{IN} = 3.3\text{ V}, C_{OUT} = 0.1\ \mu\text{F}, R_L = 500\ \Omega)$

APPLICATION INFORMATION

Input Capacitor

IntelliMAX switches don't require an input capacitor. To reduce device inrush current, a 0.1 μF ceramic capacitor, C_{IN}, is recommended close to the VIN pin. A higher value of C_{IN} can be used to further reduce the voltage drop experienced as the switch is turned on into a large capacitive load.

Output Capacitor

IntelliMAX switches work without an output capacitor. If the applications parasitic board inductance forces V_{OUT} below GND when switching off, a 0.1 μF capacitor, C_{OUT}, should be placed between V_{OUT} and GND.

Fall Time

Device output fall time can be calculated based on RC constant of external components as follows:

$$t_F = R_L \times C_L \times 2.2 \quad (\text{eq. 1})$$

where t_F is 90% to 10% fall time, R_L is output, load and C_L is output capacitor.

The same equation works for a device with a pull-down output resistor, then R_L is replaced by a parallel connected pull-down and external output resistor combination, as follows:

$$t_F = \frac{R_L \times R_{PD} \times C_L}{R_L + R_{PD}} \times 2.2 \quad (\text{eq. 2})$$

where t_F is 90% to 10% fall time, R_L is output load, R_{PD} is output pull-down resistor (65 Ω typical), and C_L is the output capacitor.

RECOMMENDED LAND PATTERN AND LAYOUT

For best thermal performance and minimal inductance and parasitic effects, it is recommended to keep input and output traces short and the capacitors as close to the device

as possible. Below is a recommended layout for this device to achieve optimum performance.

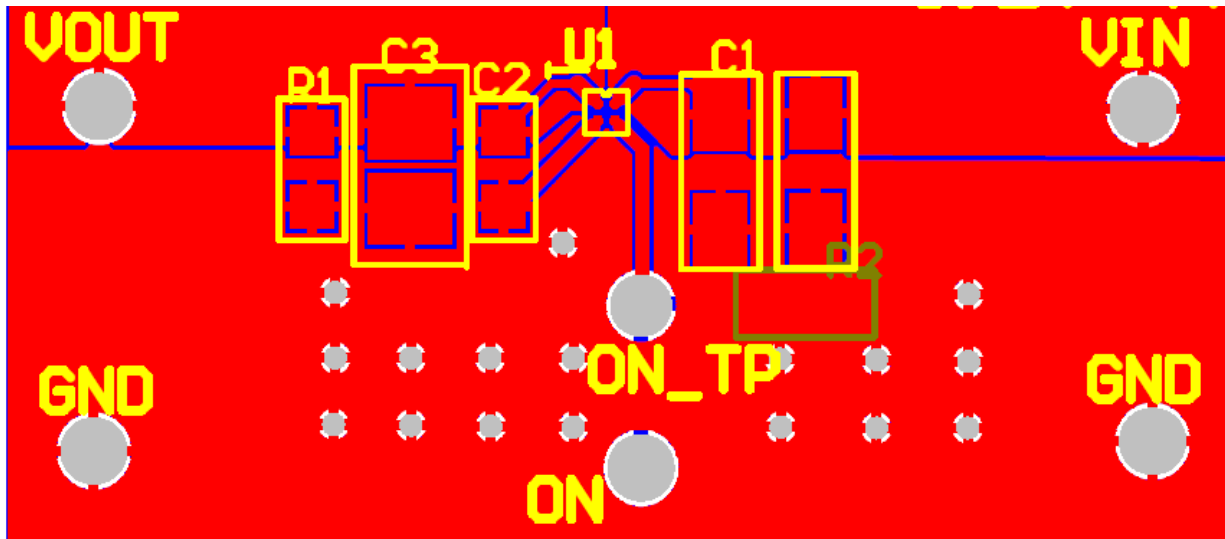

Figure 17. Recommended Land Pattern and Layout

The following information applies to the WLCSP package dimensions on the next page:

PRODUCT-SPECIFIC DIMENSIONS

| Product | D | E | X | Y |
|-------------|---------------|---------------|----------|----------|
| FPF1504UCX | 960 μm ±30 μm | 960 μm ±30 μm | 0.230 mm | 0.230 mm |
| FPF1504BUCX | | | | |
| FPF1504LUCX | | | | |
| FPF1504LUCX | | | | |

IntelliMAX is a trademark of Semiconductor Components Industries, LLC (SCILLC) or its subsidiaries in the United States and/or other countries.

WLCSP4 0.96x0.96x0.582
CASE 567RH
ISSUE O

DATE 30 NOV 2016

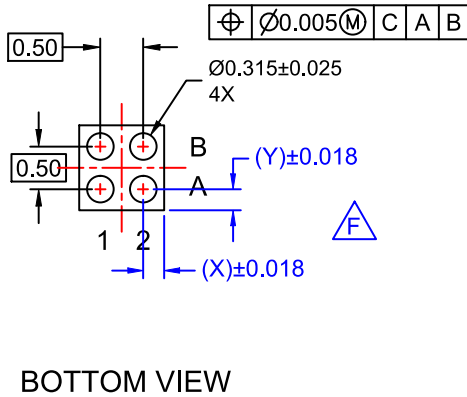
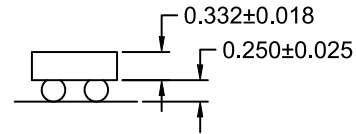
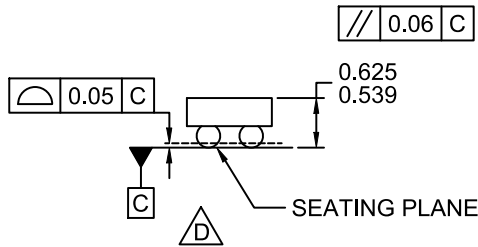
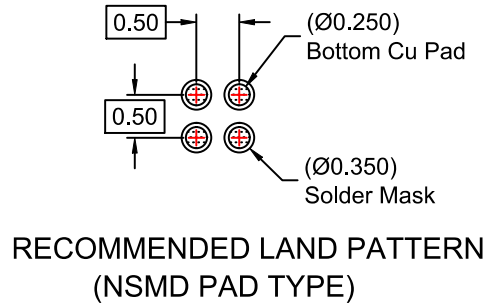
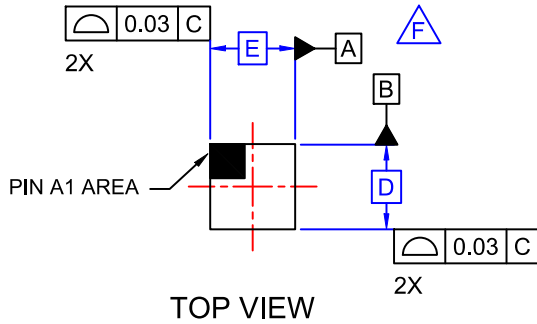

NOTES:

- A. NO JEDEC REGISTRATION APPLIES.
- B. DIMENSIONS ARE IN MILLIMETERS.
- C. DIMENSIONS AND TOLERANCES PER ASME Y14.5M, 2009.
- D. DATUM C IS DEFINED BY THE SPHERICAL CROWNS OF THE BALLS.
- E. PACKAGE NOMINAL HEIGHT IS 582 MICRONS ±43 MICRONS (539-625 MICRONS).
- F. FOR DIMENSIONS D, E, X, AND Y SEE PRODUCT DATASHEET.

| | | |
|-------------------------|-------------------------------|--|
| DOCUMENT NUMBER: | 98AON16575G | Electronic versions are uncontrolled except when accessed directly from the Document Repository. Printed versions are uncontrolled except when stamped "CONTROLLED COPY" in red. |
| DESCRIPTION: | WLCSP4 0.96x0.96x0.582 | PAGE 1 OF 1 |

ON Semiconductor and are trademarks of Semiconductor Components Industries, LLC dba ON Semiconductor or its subsidiaries in the United States and/or other countries. ON Semiconductor reserves the right to make changes without further notice to any products herein. ON Semiconductor makes no warranty, representation or guarantee regarding the suitability of its products for any particular purpose, nor does ON Semiconductor assume any liability arising out of the application or use of any product or circuit, and specifically disclaims any and all liability, including without limitation special, consequential or incidental damages. ON Semiconductor does not convey any license under its patent rights nor the rights of others.

onsemi, **Onsemi**, and other names, marks, and brands are registered and/or common law trademarks of Semiconductor Components Industries, LLC dba "**onsemi**" or its affiliates and/or subsidiaries in the United States and/or other countries. **onsemi** owns the rights to a number of patents, trademarks, copyrights, trade secrets, and other intellectual property. A listing of **onsemi**'s product/patent coverage may be accessed at www.onsemi.com/site/pdf/Patent-Marking.pdf. **onsemi** reserves the right to make changes at any time to any products or information herein, without notice. The information herein is provided "as-is" and **onsemi** makes no warranty, representation or guarantee regarding the accuracy of the information, product features, availability, functionality, or suitability of its products for any particular purpose, nor does **onsemi** assume any liability arising out of the application or use of any product or circuit, and specifically disclaims any and all liability, including without limitation special, consequential or incidental damages. Buyer is responsible for its products and applications using **onsemi** products, including compliance with all laws, regulations and safety requirements or standards, regardless of any support or applications information provided by **onsemi**. "Typical" parameters which may be provided in **onsemi** data sheets and/or specifications can and do vary in different applications and actual performance may vary over time. All operating parameters, including "Typicals" must be validated for each customer application by customer's technical experts. **onsemi** does not convey any license under any of its intellectual property rights nor the rights of others. **onsemi** products are not designed, intended, or authorized for use as a critical component in life support systems or any FDA Class 3 medical devices or medical devices with a same or similar classification in a foreign jurisdiction or any devices intended for implantation in the human body. Should Buyer purchase or use **onsemi** products for any such unintended or unauthorized application, Buyer shall indemnify and hold **onsemi** and its officers, employees, subsidiaries, affiliates, and distributors harmless against all claims, costs, damages, and expenses, and reasonable attorney fees arising out of, directly or indirectly, any claim of personal injury or death associated with such unintended or unauthorized use, even if such claim alleges that **onsemi** was negligent regarding the design or manufacture of the part. **onsemi** is an Equal Opportunity/Affirmative Action Employer. This literature is subject to all applicable copyright laws and is not for resale in any manner.

PUBLICATION ORDERING INFORMATION

LITERATURE FULFILLMENT:

Email Requests to: orderlit@onsemi.com

onsemi Website: www.onsemi.com

TECHNICAL SUPPORT

North American Technical Support:

Voice Mail: 1 800-282-9855 Toll Free USA/Canada

Phone: 011 421 33 790 2910

Europe, Middle East and Africa Technical Support:

Phone: 00421 33 790 2910

For additional information, please contact your local Sales Representative