

# IXIAN-EC™

## Conductivity Transmitter

Reads	<b>Conductivity</b>
Range	<b>0.07µS – 100,000µS</b>
Accuracy	<b>+/- 2%</b>
Calibration	<b>1 or 2 point</b> remotely through PLC or directly on board
Supported probes	<b>Any two lead</b> <b>Conductivity probe</b> (K 0.01, K 0.1, K 1.0, K 10)
Temp probe	<b>PT-100 or PT-1000</b>
Auto temp compensation	<b>Yes</b>
Mount	<b>35mm Din rail</b>
Output	<b>4 – 20mA</b>
Operating voltage	<b>9VDC – 36VDC</b>
Electrically isolated	<b>Yes</b>

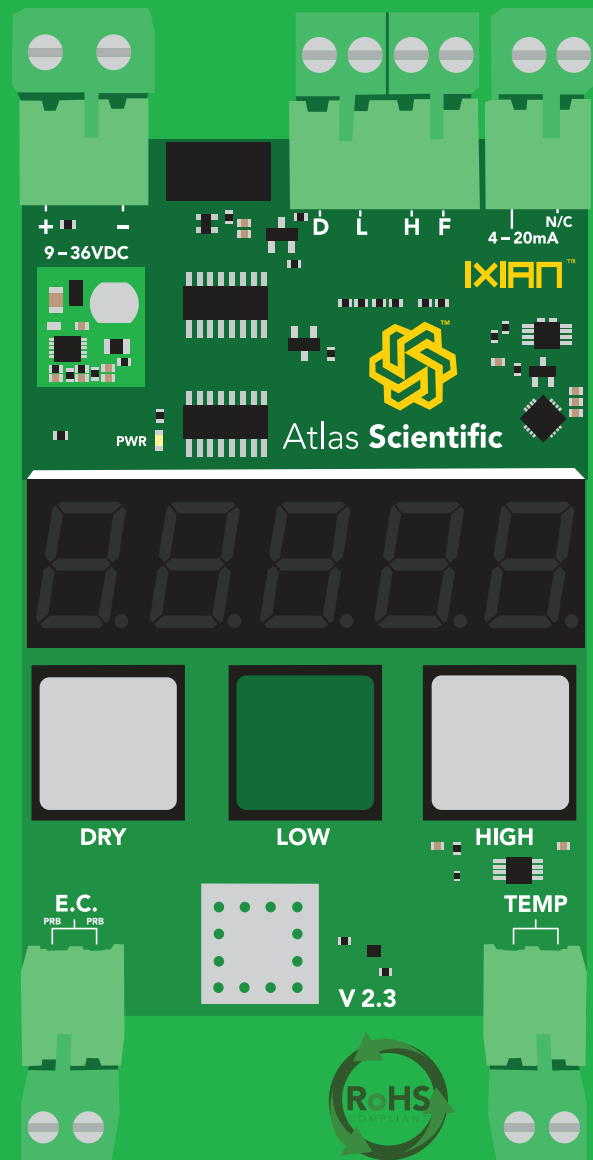

# Table of contents

Product update	3	Power connection	8
Transmitter dimensions	4	Conductivity connection	9
Wiring diagram	5	Temperature connection	10
Operating principle	6	4–20mA connection	11
Mounting	7		

**4 – 20mA conductivity transmission** 12

**Reading 4 – 20mA output  
with a multimeter** 13

**Resolution** 14

**PLC calibration node** 15

**Fault detect line** 16

**Selecting a probe type** 17

**Calibration theory** 18

**Dry calibration** 18

**Low point calibration** 19

**High point calibration** 20

**PLC calibration** 21

**4–20mA calibration** 22

**4–20mA High** 23

**4–20mA Low** 24

**Temperature compensation** 25

**Factory reset** 26

**How to smooth conductivity  
readings on the PLC side** 27

**How to derive TDS/PPM  
from conductivity** 27

# Product update

## K 1.0 Range $1\mu\text{S}$ – $100,000\mu\text{S}$

After extensive testing, the sensing range of a K 1.0 probe can be safely extended from **1– $25,000\mu\text{S}$  (standard range)** to a new **extended range from 1– $100,000\mu\text{S}$** . These tests were done using a PLC with a 16-Bit ADC.

If you chose to extend the range of your K 1.0 probe, we recommended using at least a 16-Bit ADC. Extending the range of the K 1.0 probe lowers the resolution from  $0.38\mu\text{S}$  per ADC point to  $1.52\mu\text{S}$  per ADC point.

Eventually this update will be incorporated into the transmitter's firmware. Until that happens, the extended K 1.0 sensing range can be extended by using a simple hack.

1. Connect a K 1.0 conductivity probe of your choice.
2. Set the transmitter to a K 10 probe.
3. Calibrate the K 1.0 probe using the calibration points required for the K 10 probe.
4. Done.

**Basically, connect a K 1.0 probe but tell the transmitter it's a K 10 probe.**

–Atlas Scientific

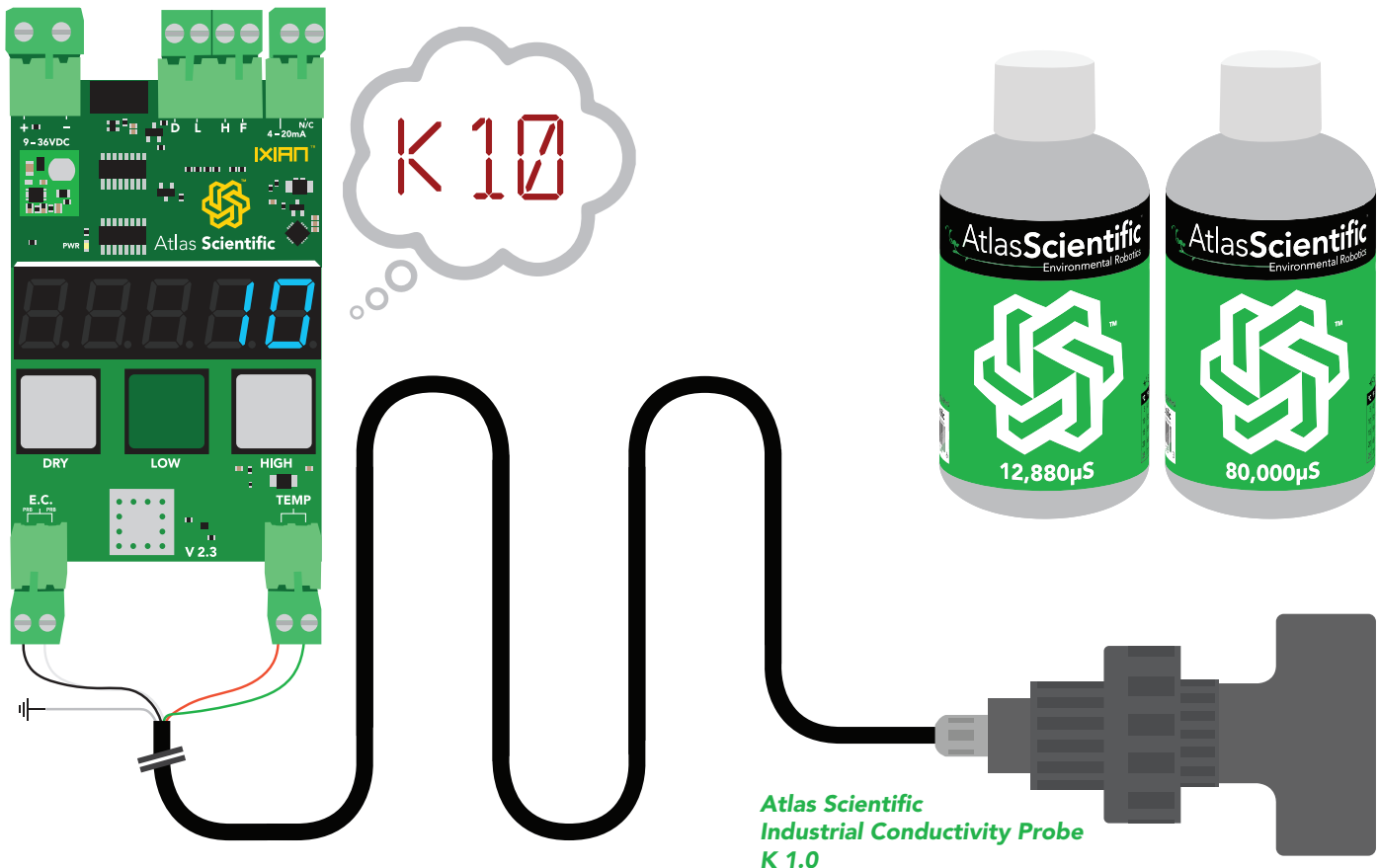

# Transmitter dimensions

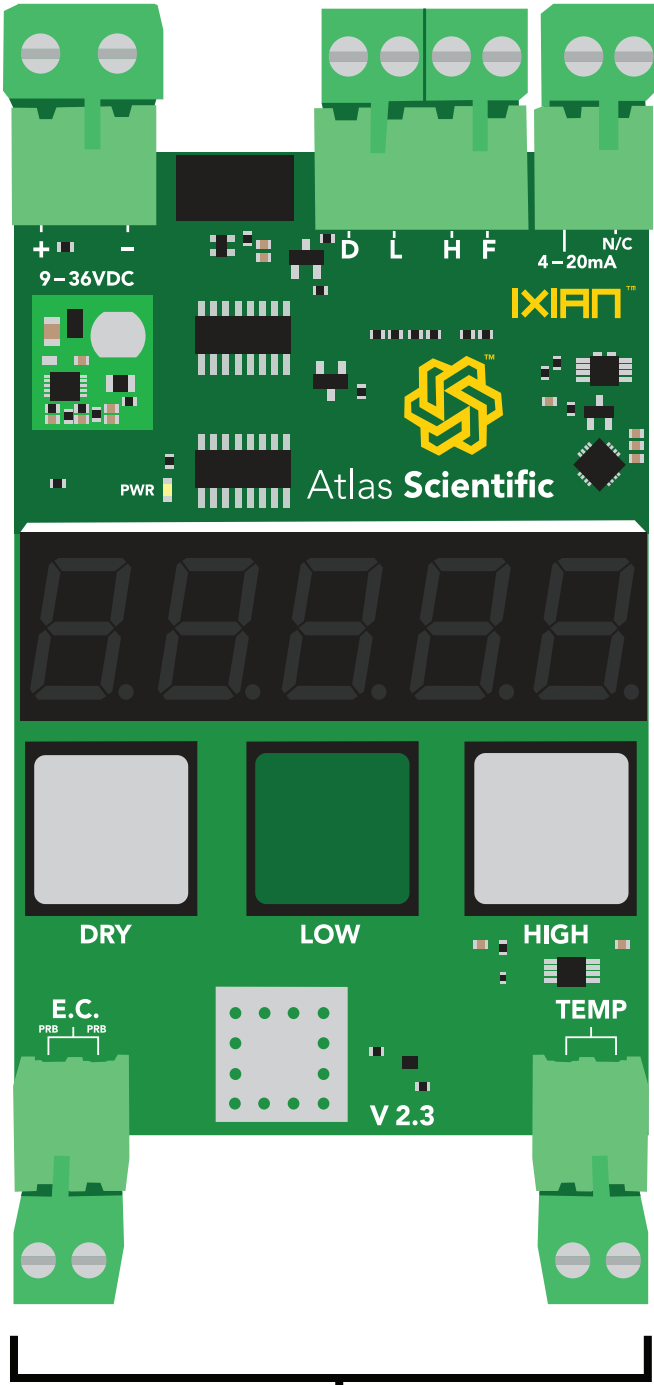

66.5mm  
(2.6")

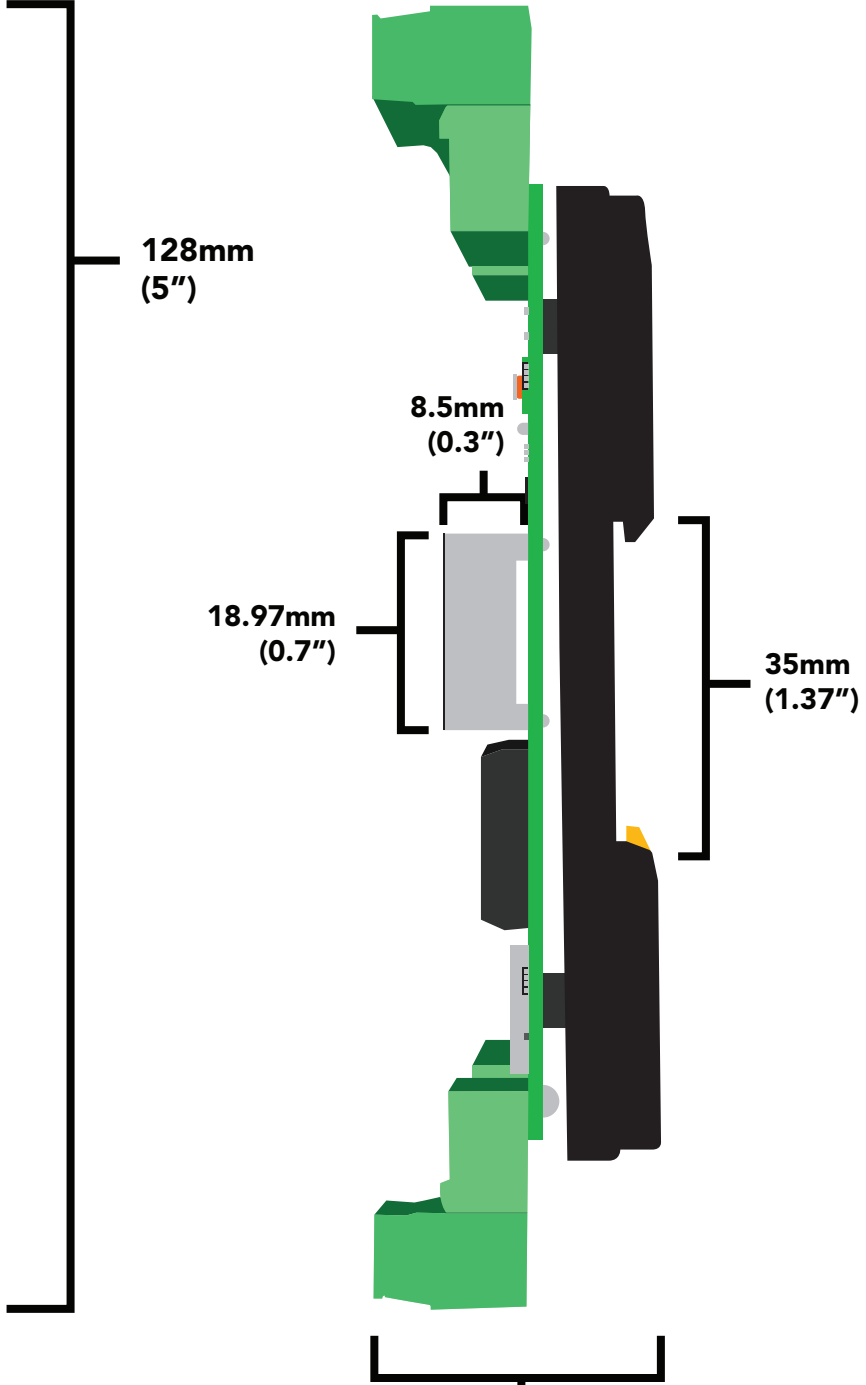

# Wiring diagram

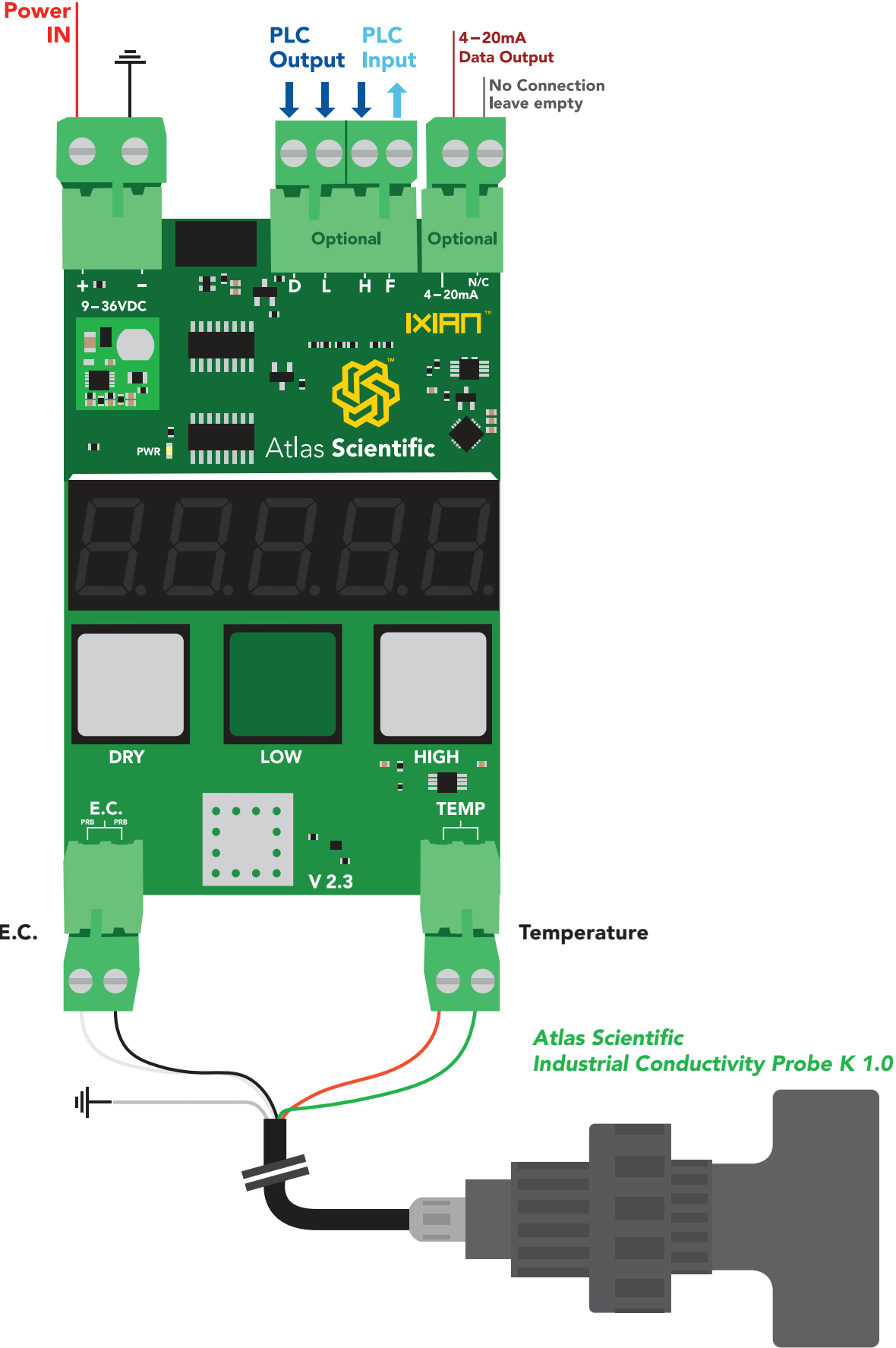

# Operating principle

An E.C. (**electrical conductivity**) probe measures the electrical conductivity in a solution. It is commonly used in hydroponics, aquaculture and freshwater systems to monitor the amount of nutrients, salts or impurities in the water.

Inside the conductivity probe, two electrodes are positioned opposite from each other, an AC voltage is applied to the electrodes causing cations to move to the negatively charged electrode, while the anions move to the positively electrode. The more free electrolyte the liquid contains, the higher the electrical conductivity.

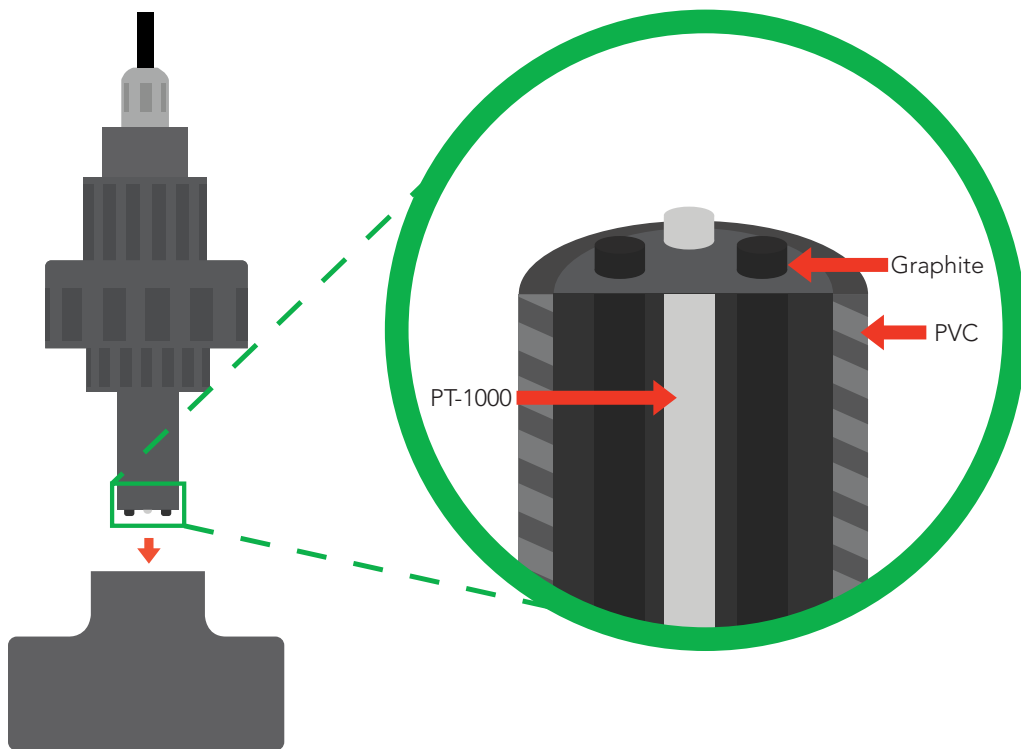
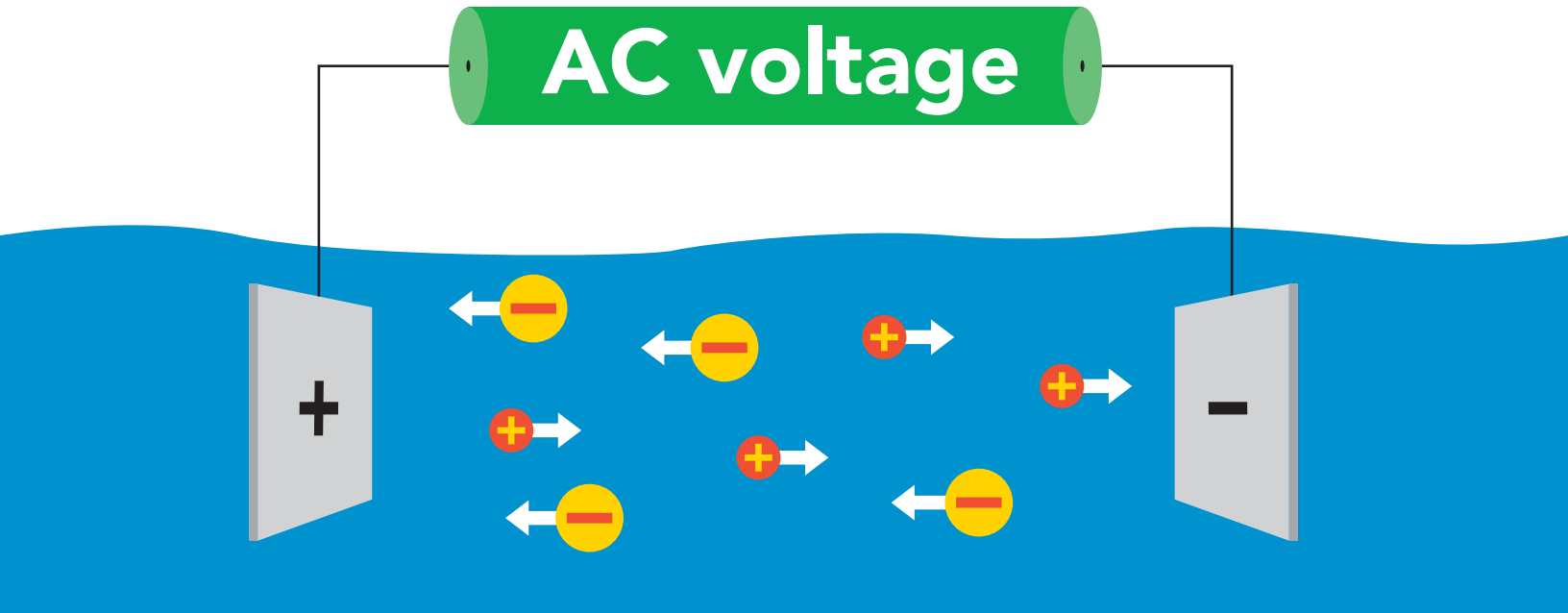

# Mounting

The IXIAN™ Conductivity Transmitter is specifically designed to be mounted to a 35mm din rail. To detach the transmitter from the din rail, pull down on the din rail release notch.

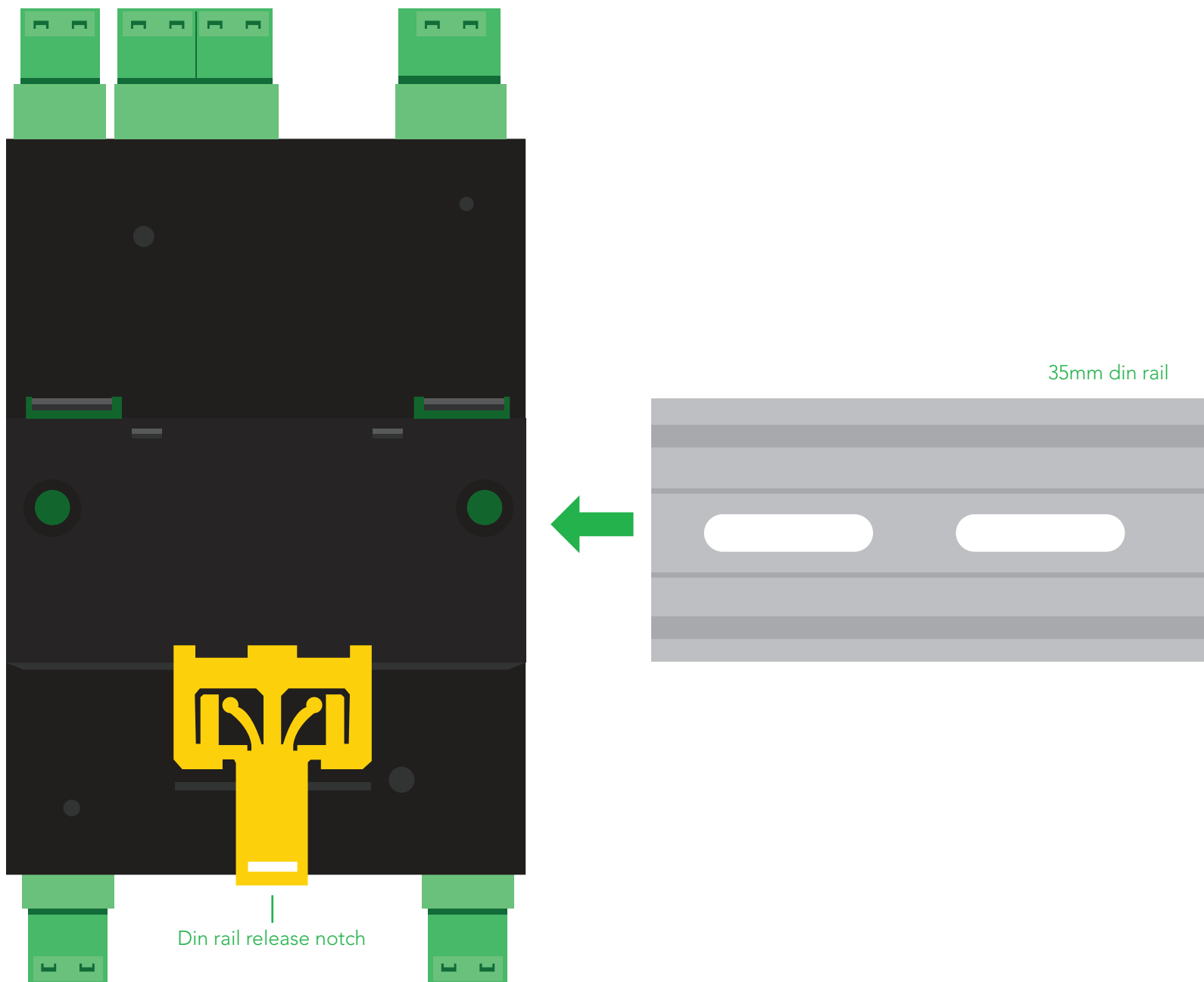

# Power connection

Any DC voltage from 9V – 36V can be used to power the IXIAN™ Conductivity Transmitter. The power connector is keyed differently and is larger than the other connectors.

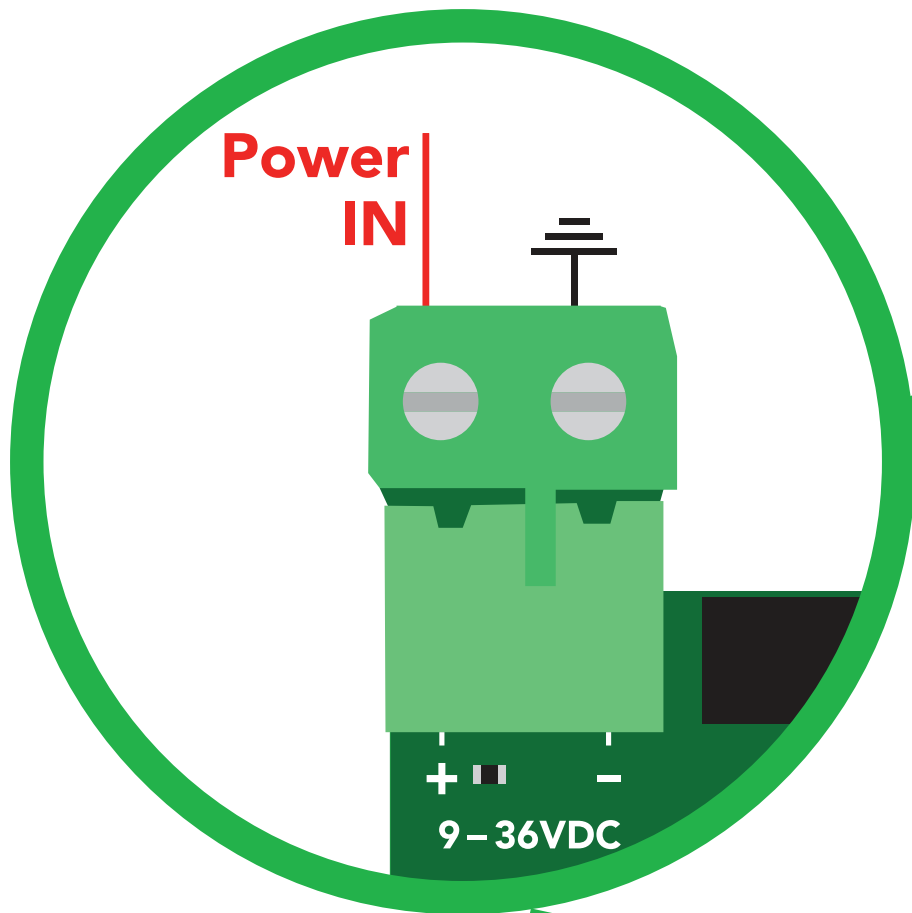

## Power consumption table

\*no probe connected

VDC	mA
9	66
12	45
24	21
36	14

The IXIAN™ Conductivity Transmitter must be connected to a power source that provides a smooth, ripple free DC voltage. Any DC power supply designed for a PLC should be sufficient. Connecting this device to a cheap AC adapter also known as a “wall wart” may interfere with the devices ability to provide smooth readings that do not fluctuate.

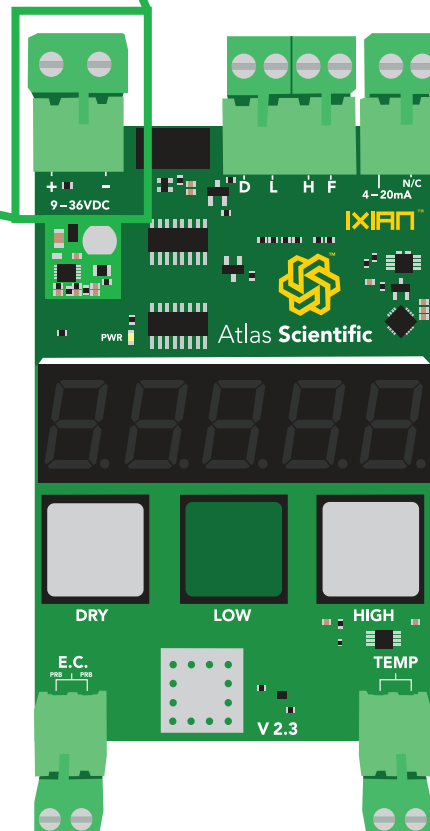



# Conductivity connection

Any brand of two wire conductivity probe can be used with the IXIAN™ Conductivity Transmitter, as long as the probe is one of 4 possible K values; *K 0.01*, *K 0.1*, *K 1.0* and *K 10* (also known as the probes cell constant).

## Probe types that can be connected

Probe type	Range	Range in TDS
K 0.01	0.07µS – 2,000µS 4mA = 0µS 4.0056mA = 0.07µS 20mA = 2,000µS	1 – 1,080
K 0.1	1µS – 4,000µS 4mA = 0µS 4.004 = 1µS 20mA = 4,000µS	1 – 2,160
K 1.0	1µS – 25,000µS 4mA = 0µS 4.00064mA = 1µS 20mA = 25,000µS	1 – 13,500
K 10	1µS – 100,000µS 4mA = 0µS 4.00016mA = 1µS 20mA = 100,000µS	1 – 54,000

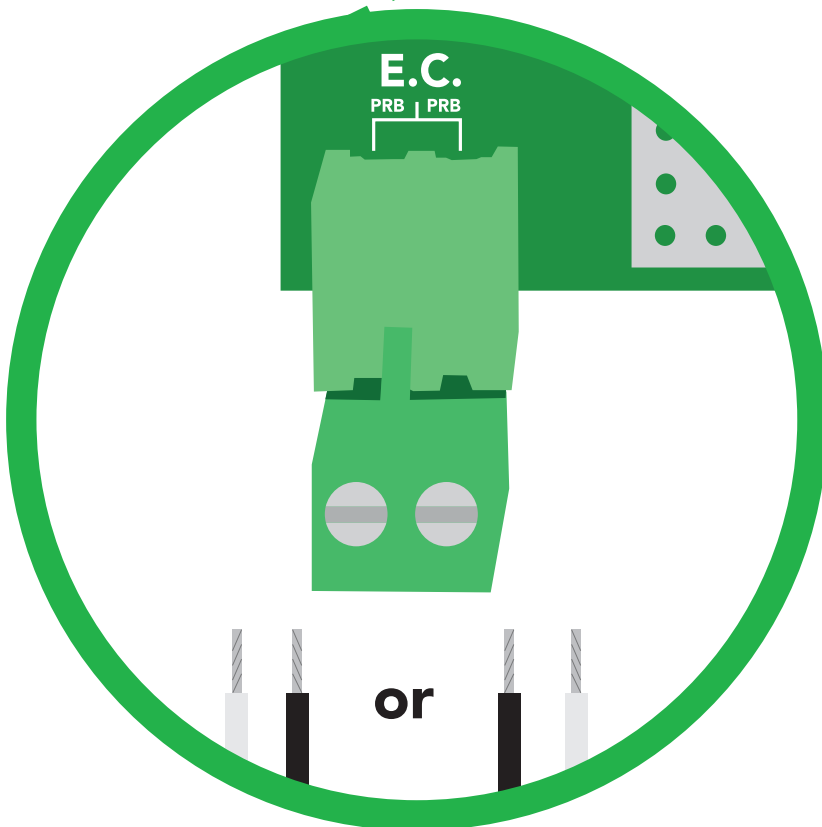
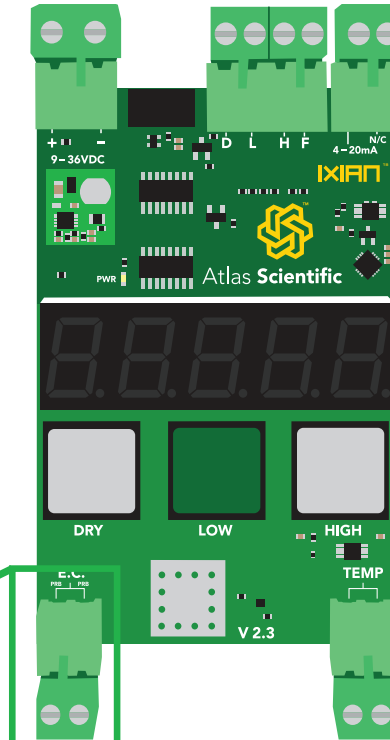

Either method of wiring will produce the same result. ***There is no polarity.***

# Temperature connection

Any brand of PT-100 or PT-1000 temperature probe can be connected to the IXIAN™ Conductivity Transmitter.

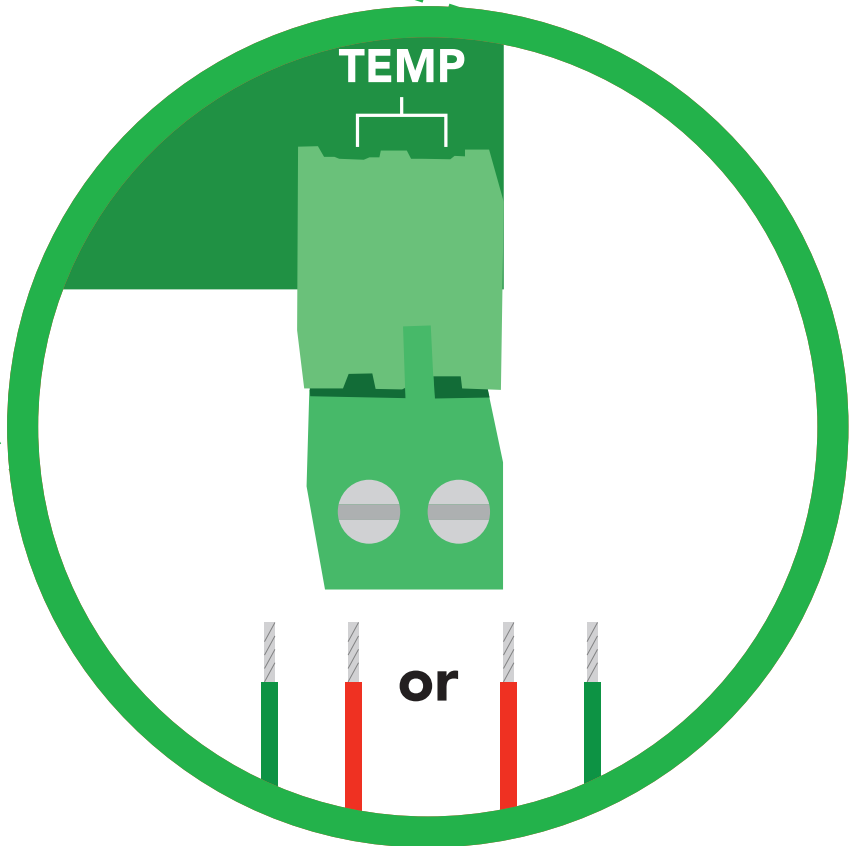
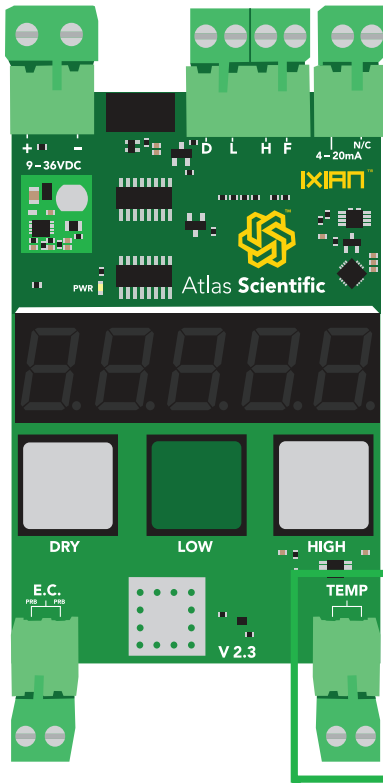

Either method of wiring will produce the same result. ***There is no polarity.***

# 4 – 20mA connection

Connecting the 4–20mA data output to your PLC, allows the IXIAN™ Conductivity Transmitter to communicate with your PLC.

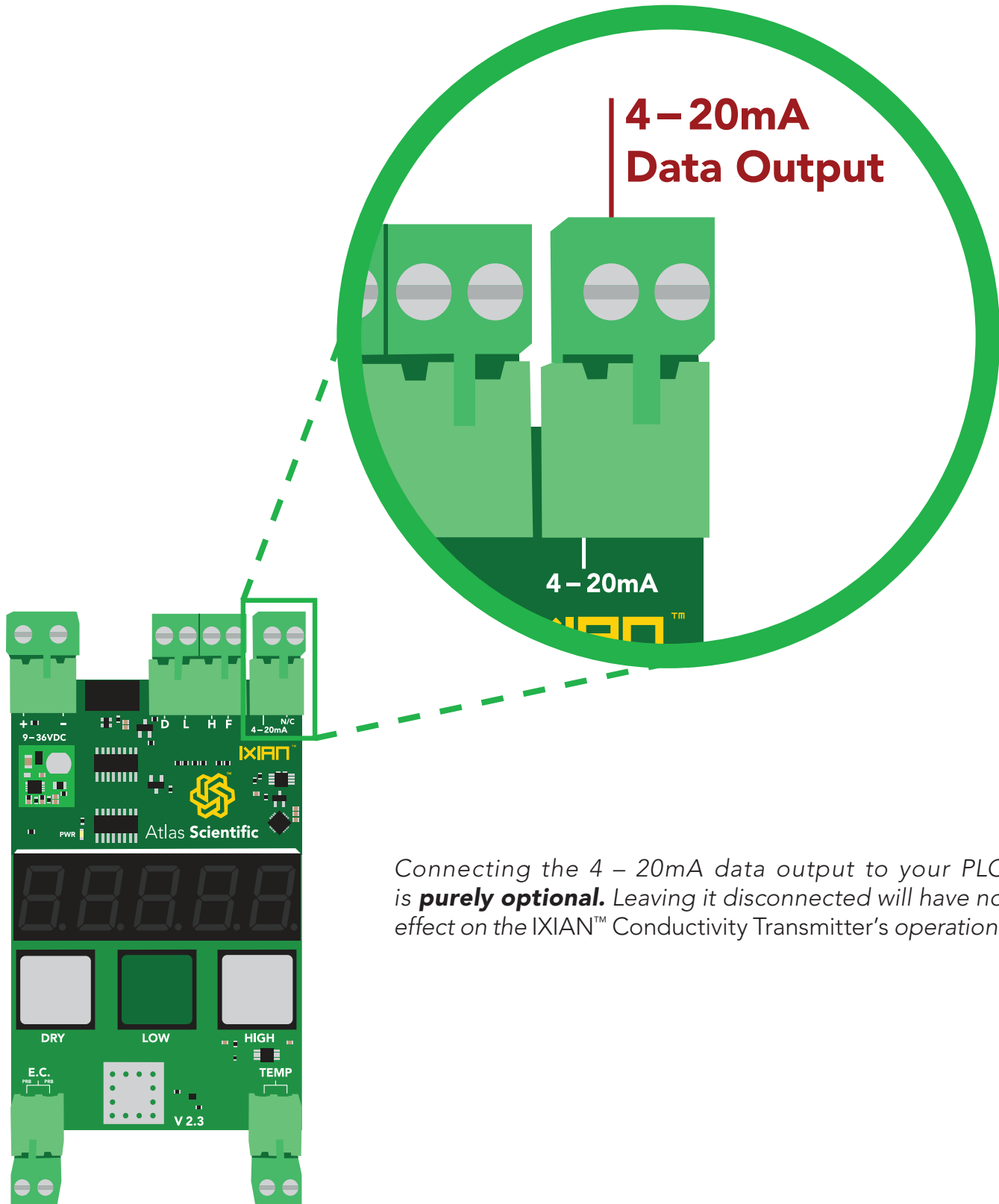

Connecting the 4 – 20mA data output to your PLC is **purely optional**. Leaving it disconnected will have no effect on the IXIAN™ Conductivity Transmitter's operation.

# 4 – 20mA conductivity transmission

The Conductivity value that is visible on the seven segment LED screen is also, simultaneously transmitted through the 4 – 20mA data output.

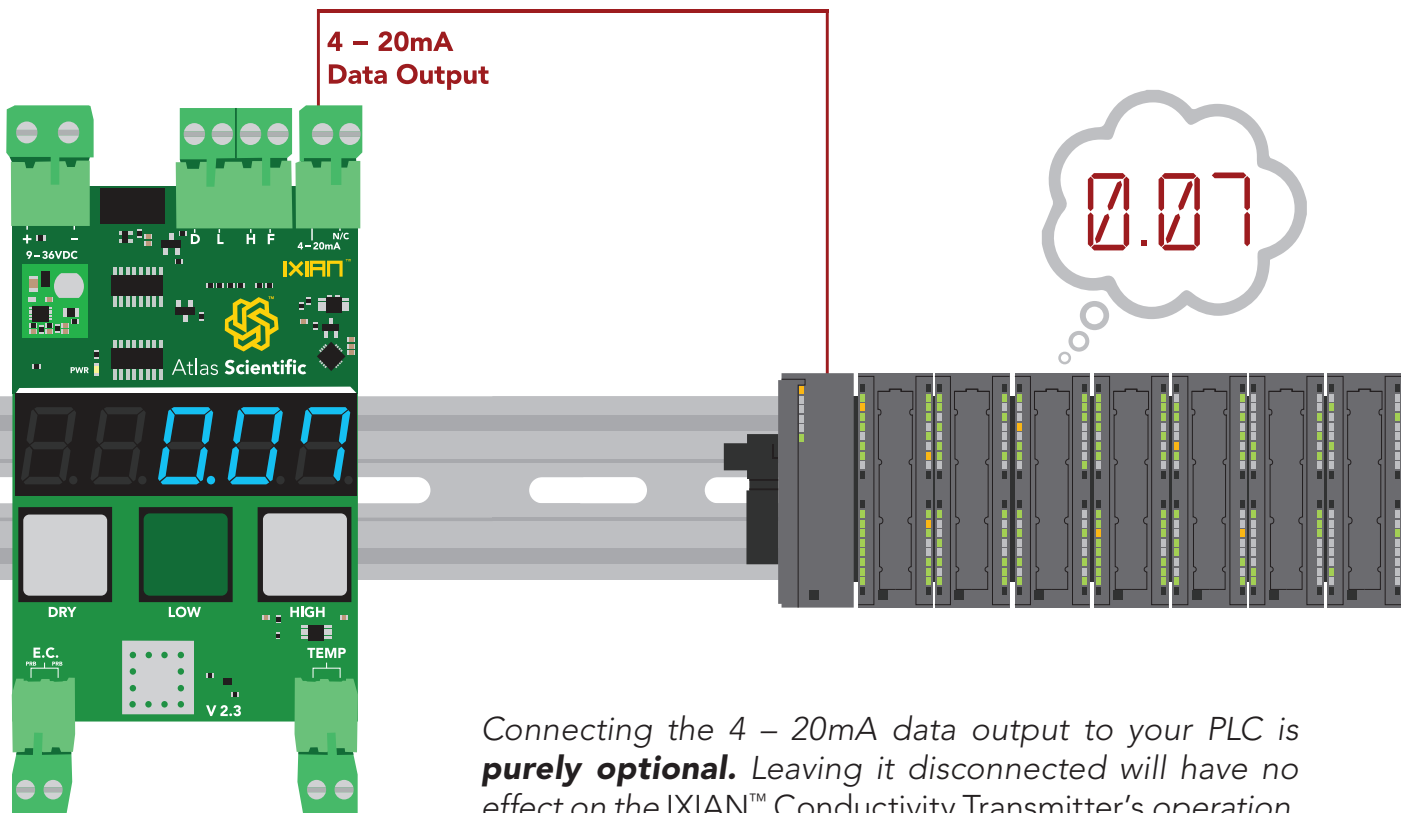

Connecting the 4 – 20mA data output to your PLC is **purely optional**. Leaving it disconnected will have no effect on the IXIAN™ Conductivity Transmitter's operation.

## Advanced

4 – 20mA max load resistance

$$R_{max} = \frac{(V_{in} - 1)}{0.026}$$

R = the total resistive load on the line.

V = the voltage powering the transmitter.

# Reading 4–20mA output with a multimeter

To debug the IXIAN™ Conductivity Transmitter output, first connect it to a multimeter as shown. (make sure the multimeter is set to “mA”). Once properly connected, apply the formula below (be sure to use the correct formula that corresponds to the attached probes K value).

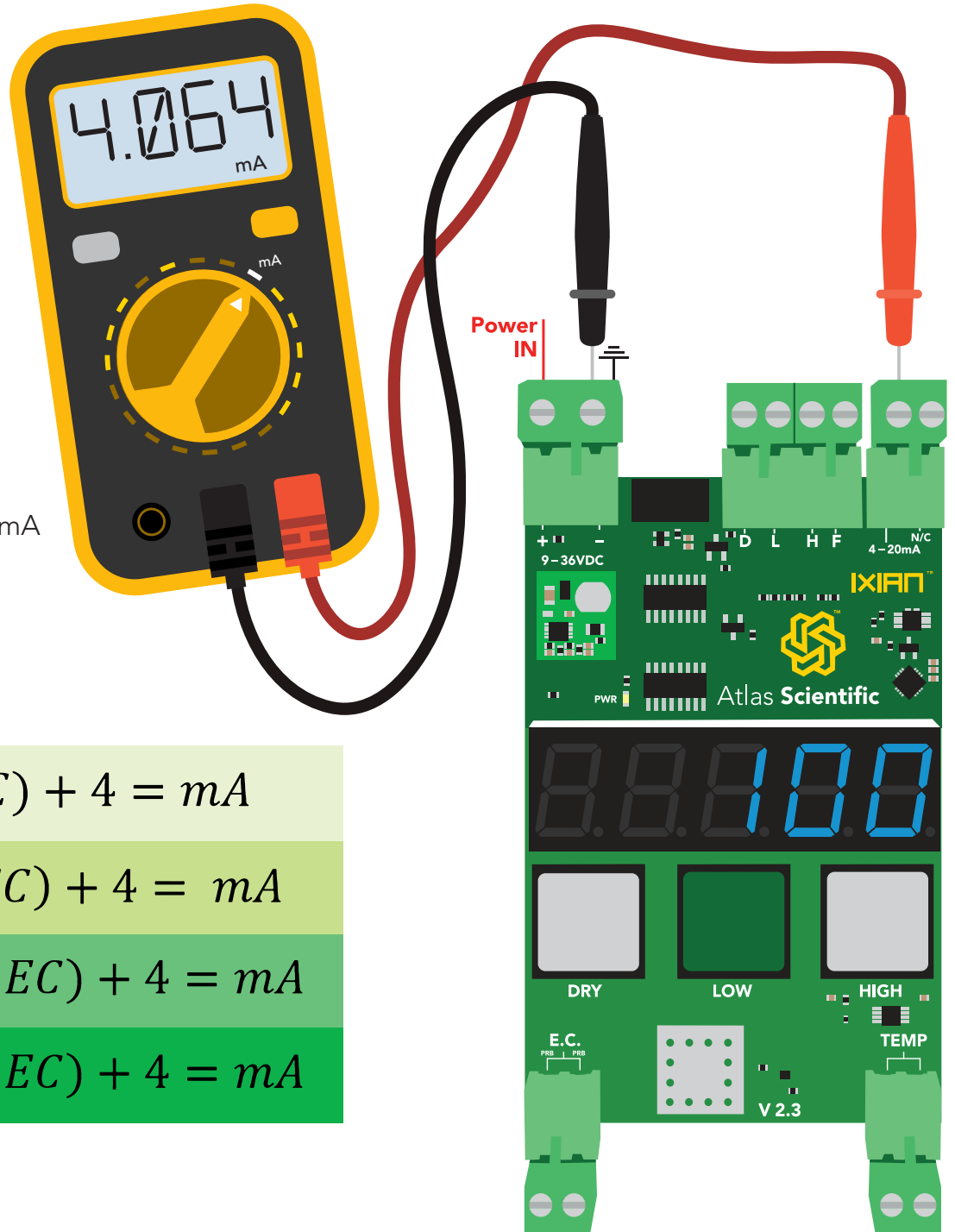

## Example

Probe: K 1.0

Reading: 100μs

$(0.00064 * 100) + 4 = 4.064 \text{ mA}$

$$\kappa 0.01 \quad (0.008 * EC) + 4 = \text{mA}$$

$$\kappa 0.1 \quad (0.004 * EC) + 4 = \text{mA}$$

$$\kappa 1.0 \quad (0.00064 * EC) + 4 = \text{mA}$$

$$\kappa 10 \quad (0.00016 * EC) + 4 = \text{mA}$$

# Resolution

The IXIAN™ Conductivity Transmitters 4 – 20mA signal has 22 bits of resolution. However the ADC resolution of your PLC will limit the resolution of your conductivity readings. The IXIAN™ Conductivity Transmitter has been built with this in mind. The set ranges for the different probe types are designed to work well with a typical 12 bit PLC ADC. Using a higher bit ADC will enable your PLC to read the conductivity with a greater resolution.

## Resolution chart

Where resolution refers to the smallest change in conductivity your PLC can detect.

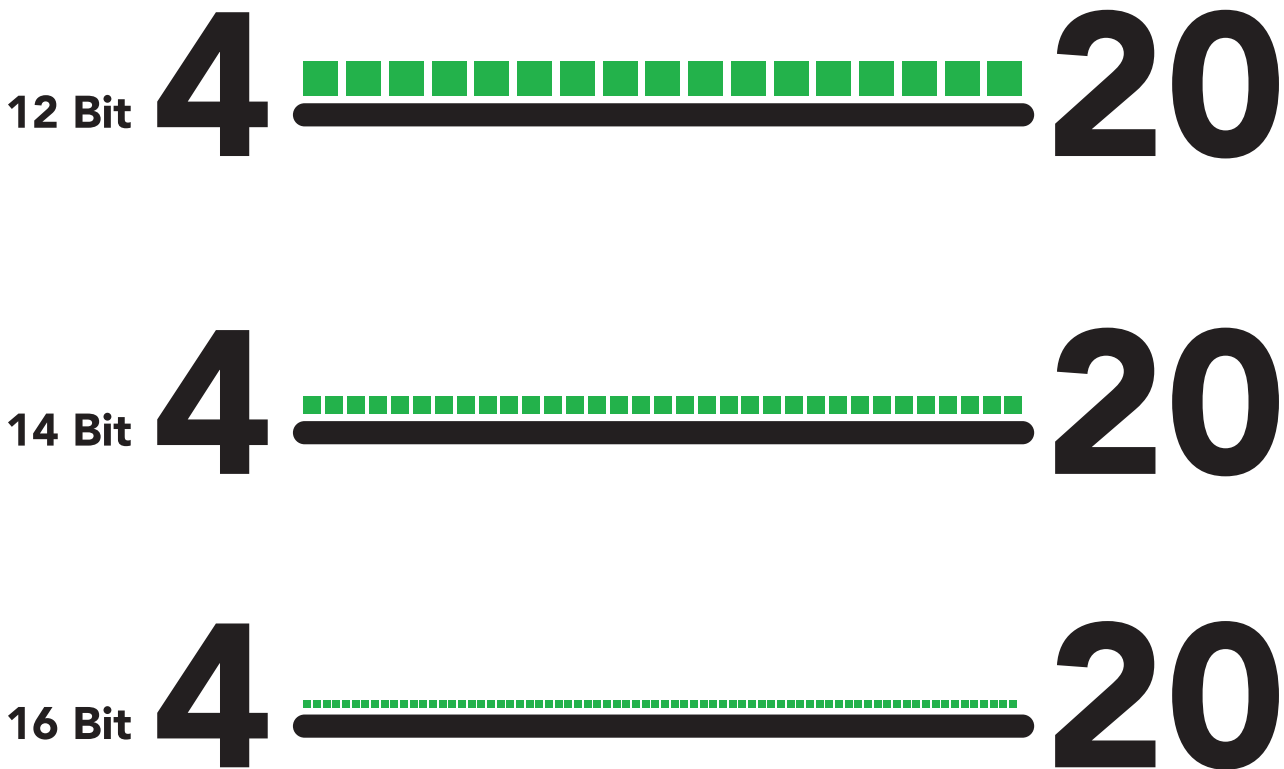

K 0.01		K 0.1		K 1.0		K 10	
12 bit	0.48 $\mu$ S	12 bit	0.97 $\mu$ S	12 bit	6.10 $\mu$ S	12 bit	24.41 $\mu$ S
14 bit	0.12 $\mu$ S	14 bit	0.24 $\mu$ S	14 bit	1.52 $\mu$ S	14 bit	6.10 $\mu$ S
16 bit	0.03 $\mu$ S	16 bit	0.06 $\mu$ S	16 bit	0.38 $\mu$ S	16 bit	1.52 $\mu$ S

# PLC calibration node

Using the three input connections marked "D", "L", "H" (**D**ry, **L**ow and **H**igh) it's possible to use a PLC to fully calibrate the IXIAN™ Conductivity Transmitter. This is particularly beneficial when using a PLC touch screen. *Setting either of these pins to high for 200ms, is the same as pressing the buttons on the transmitter.*

Sending an output signal from the PLC to the Conductivity Transmitters D, L, and H input connection will calibrate the device.

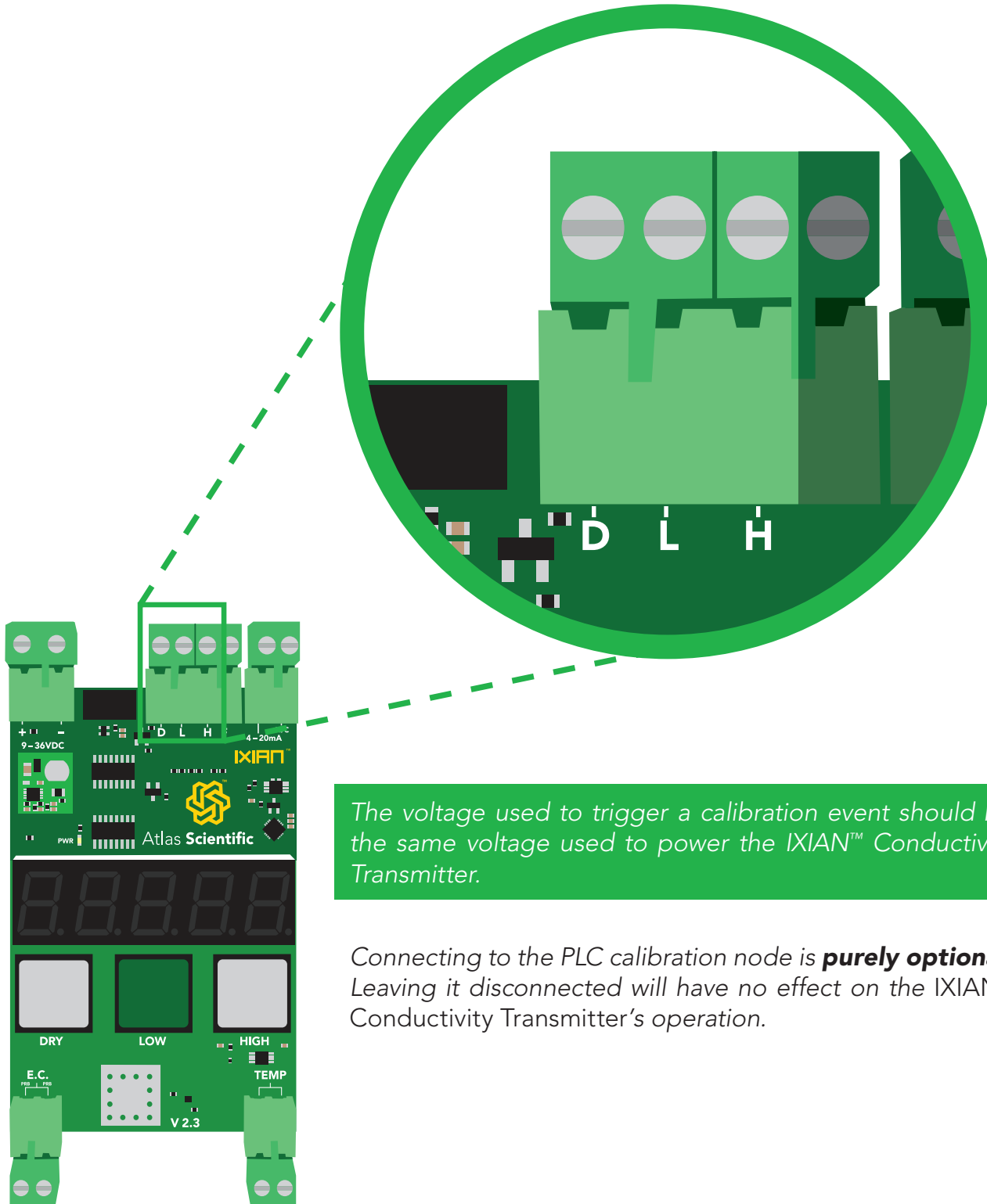

*The voltage used to trigger a calibration event should be the same voltage used to power the IXIAN™ Conductivity Transmitter.*

*Connecting to the PLC calibration node is **purely optional**. Leaving it disconnected will have no effect on the IXIAN™ Conductivity Transmitter's operation.*

# Fault detect line

The connection marked "F" is the fault detect line. During normal operation the fault detect line will output a voltage equal to the voltage used to power the device. If the IXIAN™ Conductivity Transmitter detects a problem the fault line will drop to 0 volts. When a fault is detected the fault LED will turn on.

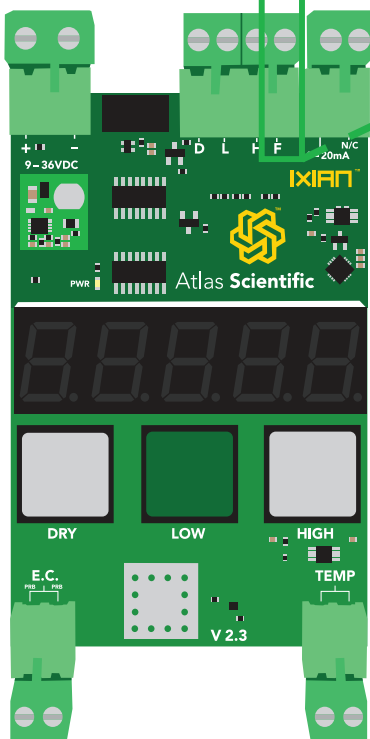
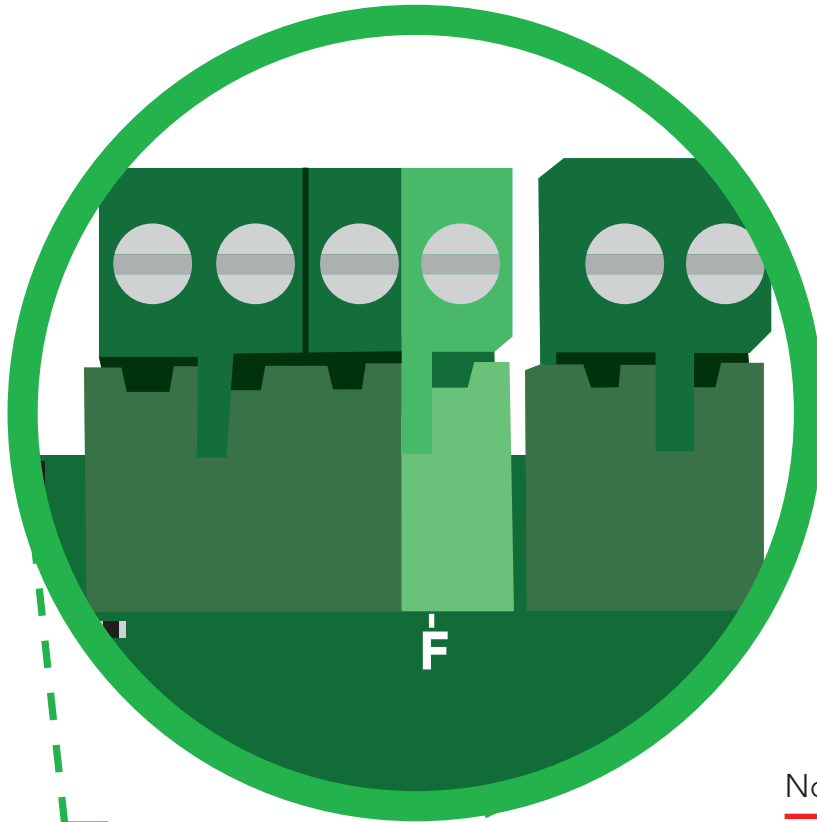

Normal operation

(24V typical)



**Fault**

0 Volts

## Example

The IXIAN™ Conductivity Transmitter is powered with 24V the "F" line will output 24V during normal operation.

## Events that will trigger the fault line to go to 0 volts

- disconnected temperature probe
- disconnected 4 – 20mA output
- calibration in process
- loss of power

Connecting to the fault detect line is **purely optional**. Leaving it disconnected will have no effect on the IXIAN™ Conductivity Transmitter's operation.



# Selecting a probe type

Any brand of two wire conductivity probe can be used with the IXIAN™ Conductivity Transmitter, as long as the probe is one of 4 possible K values; K 0.01, K 0.1, K 1.0 and K 10  
**The IXIAN™ Conductivity Transmitter defaults to a K 1.0 probe.**

To change the probe type, press and hold the two **gray** buttons marked **DRY** and **HIGH** simultaneously for 1.5 seconds.

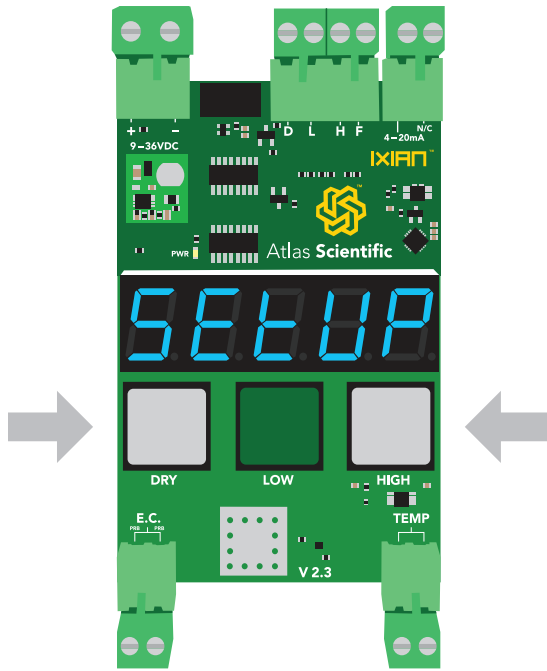

**1.5 seconds**

This will open the setup menu.  
In the setup menu there are only 3 options.

*PrObE*  
4-20 H  
4-20 L

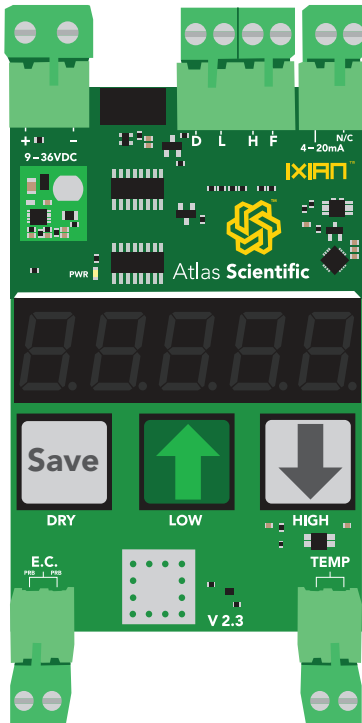

The first option is "PrObE". Press the **green LOW (up)** or **gray HIGH (down)** buttons to select your probe type. Press the **gray DRY (save)** button when the correct probe type has been selected. The probe type selection is now complete.

# Calibration theory

The IXIAN™ Conductivity Transmitter uses 3 point calibration: “dry”, “low”, and “high”. The first calibration point is “dry”. The dry calibration only needs to be done when a new probe is connected for the first time to the transmitter. The other two calibration points have been preset to specific industry standard calibration values. The calibration values are dependent on what probe type the transmitter is connected to. **The calibration data is stored in the EEPROM, and will be retained even if the Transmitter is powered off.**

Probe type	Low point calibration	High point calibration
K 0.01	84µs	1,413µs
K 0.1	84µs	1,413µs
K 1.0	1,413µs	12,880µs
K 10	12,880µs	80,000µs

## Dry calibration

This step is only done when a new probe is first connected to the device. Dry probe calibration is similar to the tare function on a scale. After dry calibration the displayed conductivity should be 0.

If the probe is not dry, dry it off. Press and hold the **DRY** calibration button for 1.5 seconds. The screen will display “dry” then “done”. Dry probe calibration has been completed.

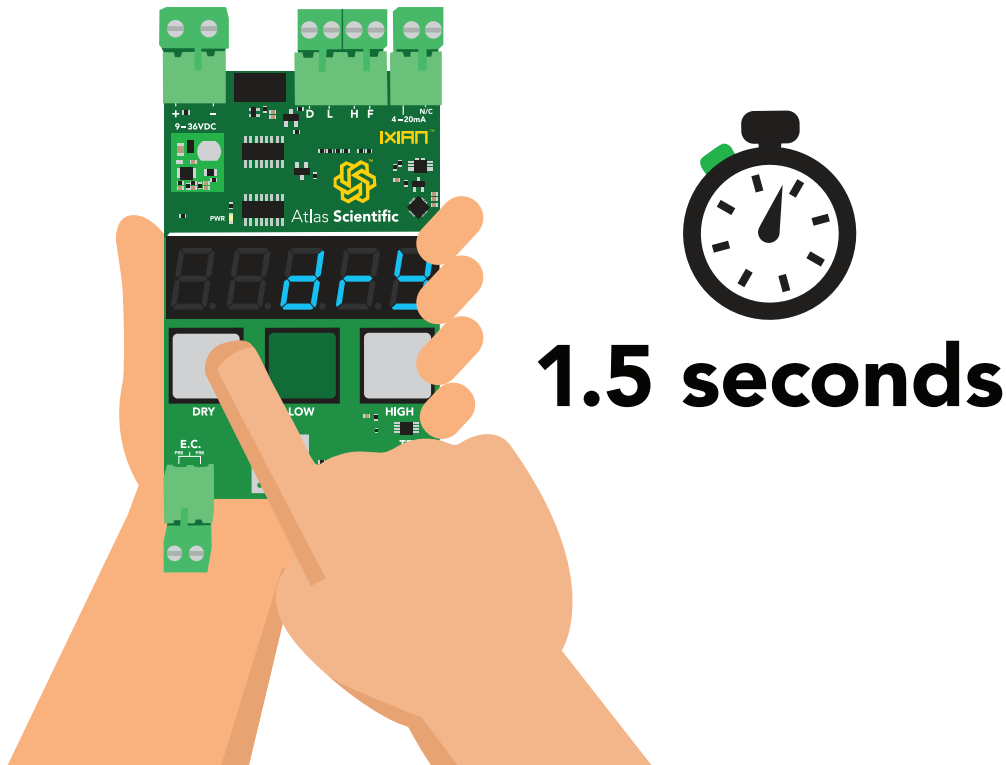

# Low point calibration

The probe should be put in the correct low point calibration solution. Wait until the conductivity readings stabilize. Press and hold the **LOW** calibration button for 1.5 seconds. The screen will display "Lo" then "dONE". The low point calibration has been completed.

Probe type	Low point calibration
------------	-----------------------

K 0.01	84 $\mu$ s
K 0.1	84 $\mu$ s
K 1.0	1,413 $\mu$ s
K 10	12,880 $\mu$ s

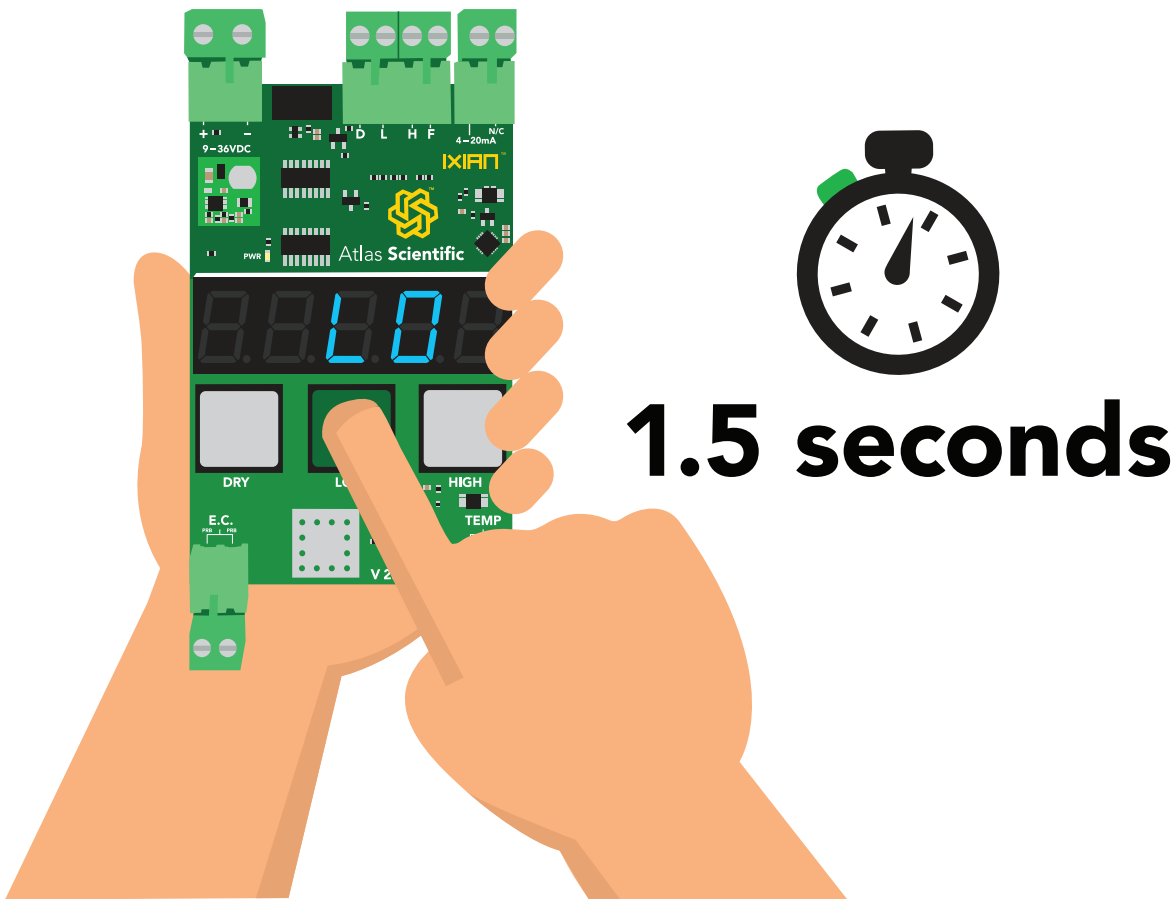

The conductivity readings will not change after low point calibration. The readings will change only when both high and low point calibration has been completed.

# High point calibration

The probe should be put in the correct high point calibration solution. Wait until the conductivity readings stabilize. Press and hold the **HIGH** calibration button for 1.5 seconds. The screen will display "HIGH" then "DONE". The High point calibration has been completed.

Probe type	High point calibration
------------	------------------------

K 0.01	1,413 $\mu$ s
--------	---------------

K 0.1	1,413 $\mu$ s
-------	---------------

K 1.0	12,880 $\mu$ s
-------	----------------

K 10	80,000 $\mu$ s
------	----------------

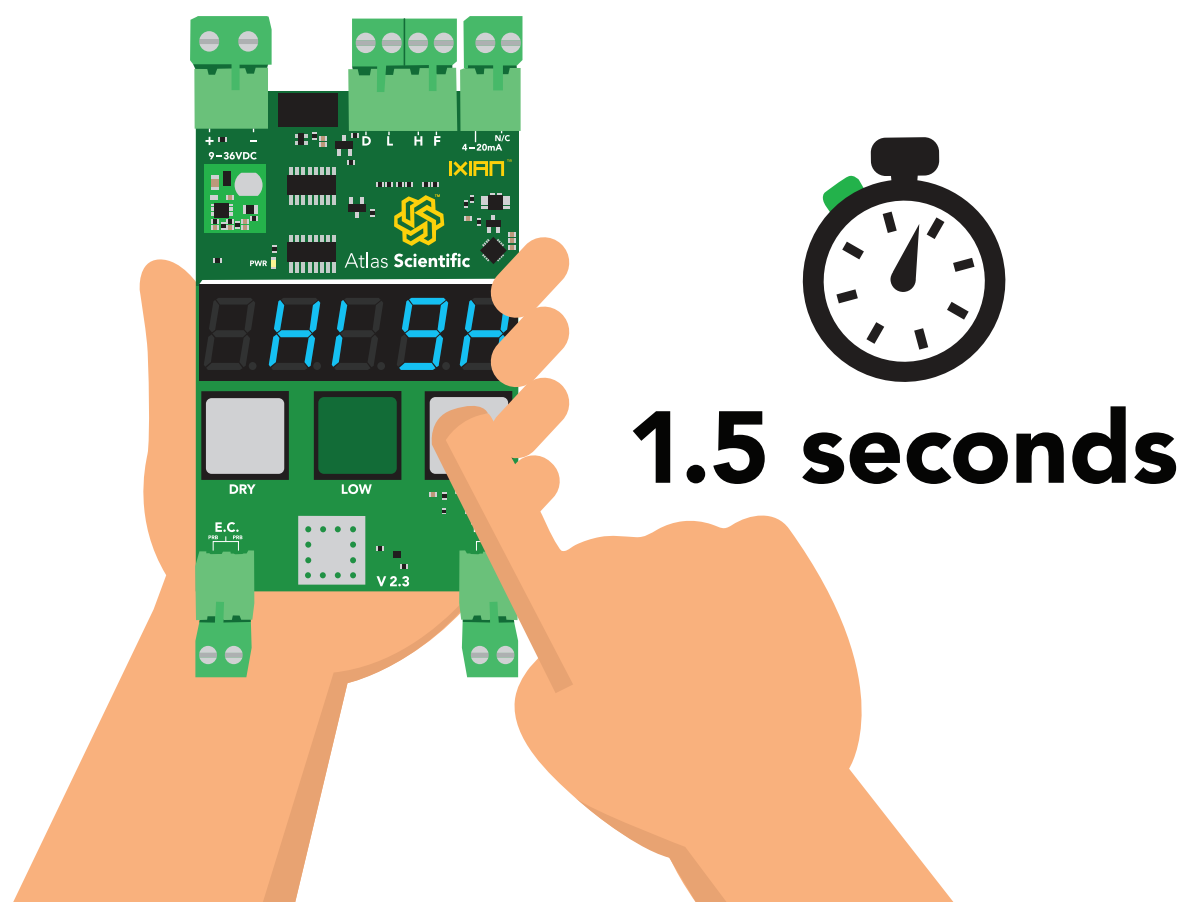

The conductivity readings will not change after low point calibration. The readings will change only when both high and low point calibration has been completed.

# PLC calibration

Using the three input connections marked "D", "L", "H" (**D**ry, **L**ow and **H**igh) it is possible to use a PLC to fully calibrate the IXIAN™ Conductivity Transmitter. Setting the PLC's output to 200ms or more will trigger a calibration event.

This is particularly beneficial when using a PLC touch screen.



The voltage used to trigger a calibration event should be the same voltage used to power the IXIAN™ Conductivity Transmitter.

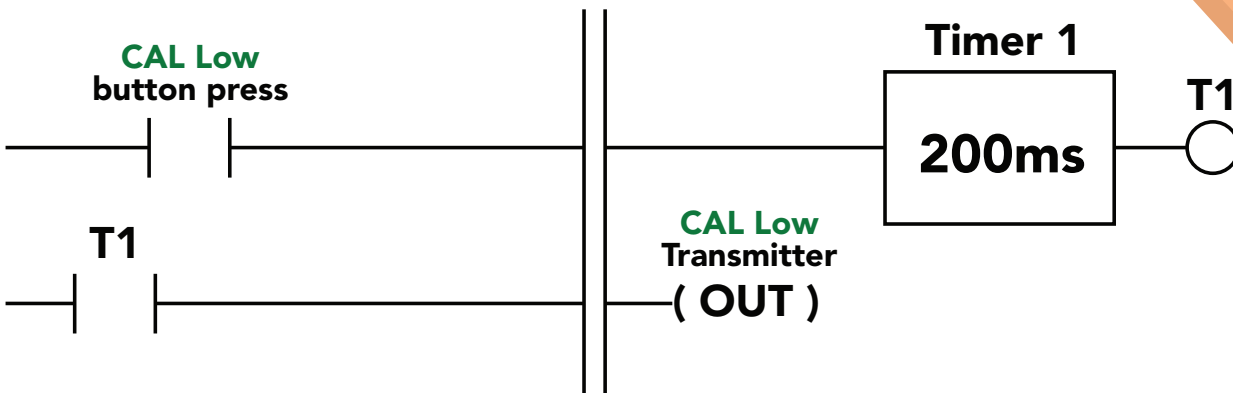

A calibration event will only trigger if the corresponding input pin has been held high for 200ms. Holding the line for more than 200ms will have no effect.

# 4 – 20mA calibration

To ensure that the PLC is receiving the most accurate 4 – 20mA signal the current output from the IXIAN™ Conductivity Transmitter can be adjusted. The 4mA signal and the 20mA signal can both be adjusted independently.

To enter 4 – 20 calibration mode press and hold the two **gray** buttons marked **DRY** and **HIGH** simultaneously for 1.5 seconds.

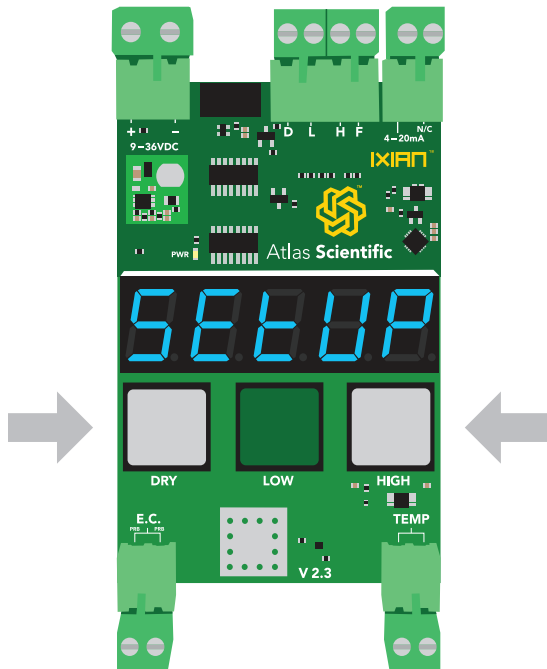

**1.5 seconds**

This will open the setup menu.  
In the setup menu there are only 3 options.

*PrObE*  
*4-20 H*  
*4-20 L*

The first option is "*PrObE*".

Press the **DRY** button to move to the second option "*4-20 H*".

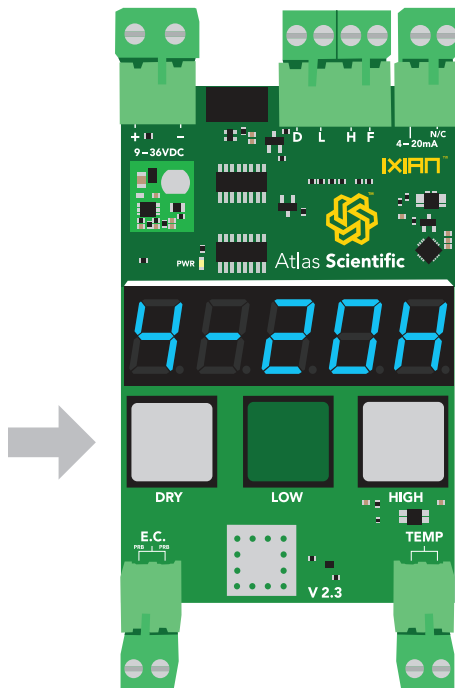

# 4 – 20mA High

The display will flash: **4-20H** (the “H” stands for high) The IXIAN™ Conductivity Transmitter will now output exactly 20mA, and your PLC should show a current of 20mA. Use the **LOW** (up) and **HIGH** (down) buttons to adjust the 20mA output so the current moves to 19.99mA, then move it back up, so it is just hits 20.00mA. When you have finished making adjustments, press the **DRY** (save) button to confirm.

The 20mA offset will be permanently stored in memory.

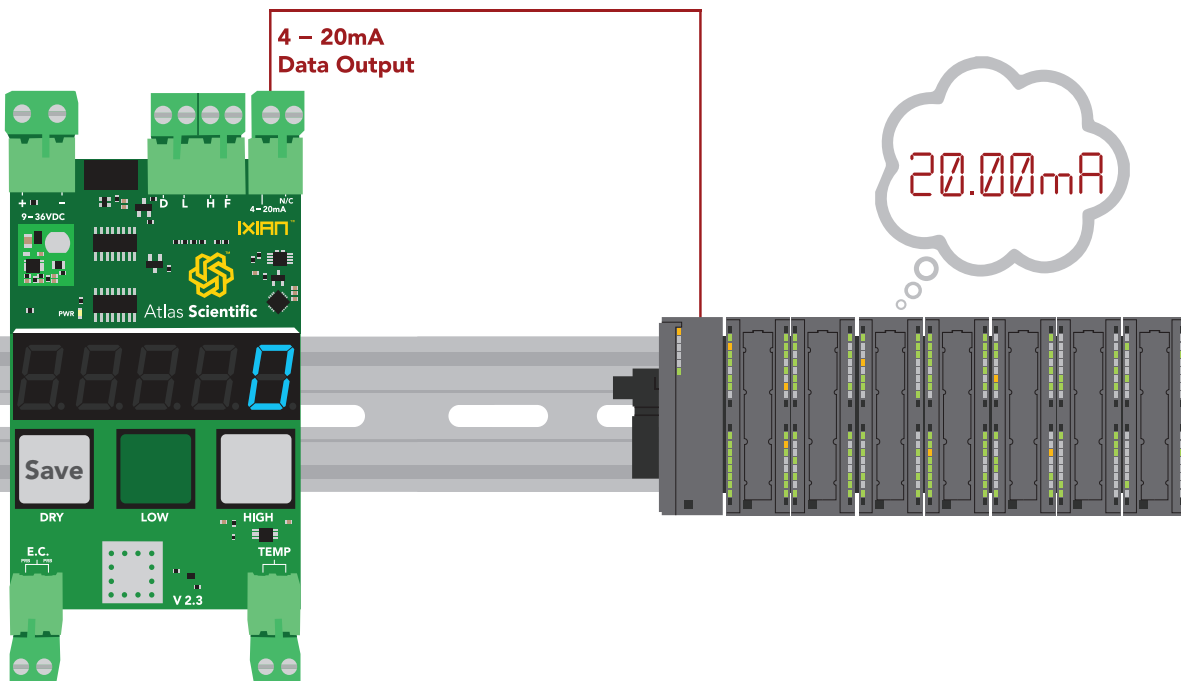
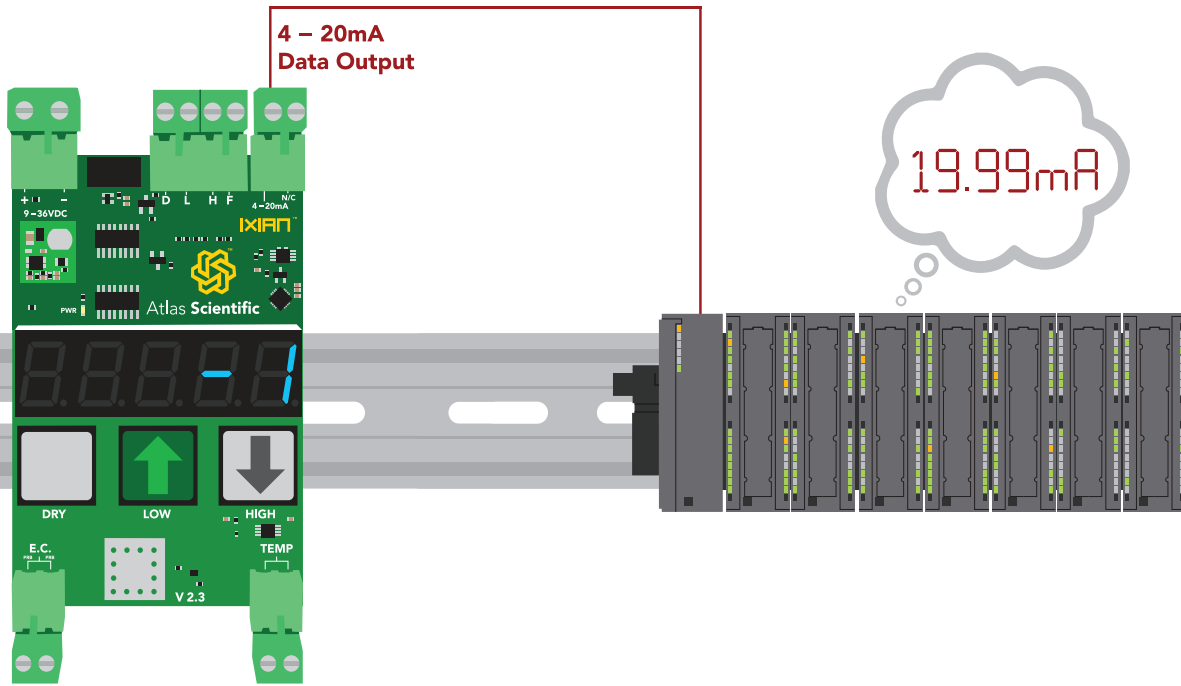

# 4 – 20mA Low

The display will flash: **4-20L** (the "L" stands for low) The IXIAN™ Conductivity Transmitter will now output exactly 4mA, and your PLC should show a current of 4mA. Use the **LOW** (up) and **HIGH** (down) buttons to adjust the 4mA output so the current moves to 3.99mA, then move it back up, so it is just hits 4.00mA. When you have finished making adjustments, press the **DRY** (save) button to confirm.

The 20mA offset will be permanently stored in memory.

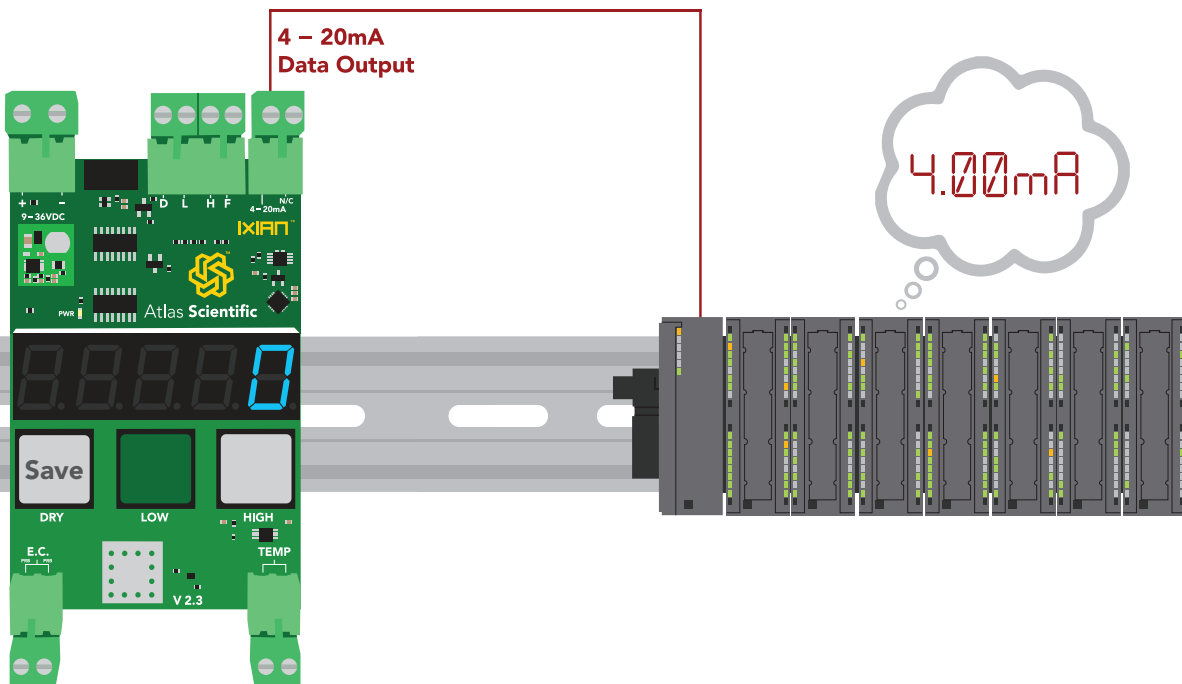
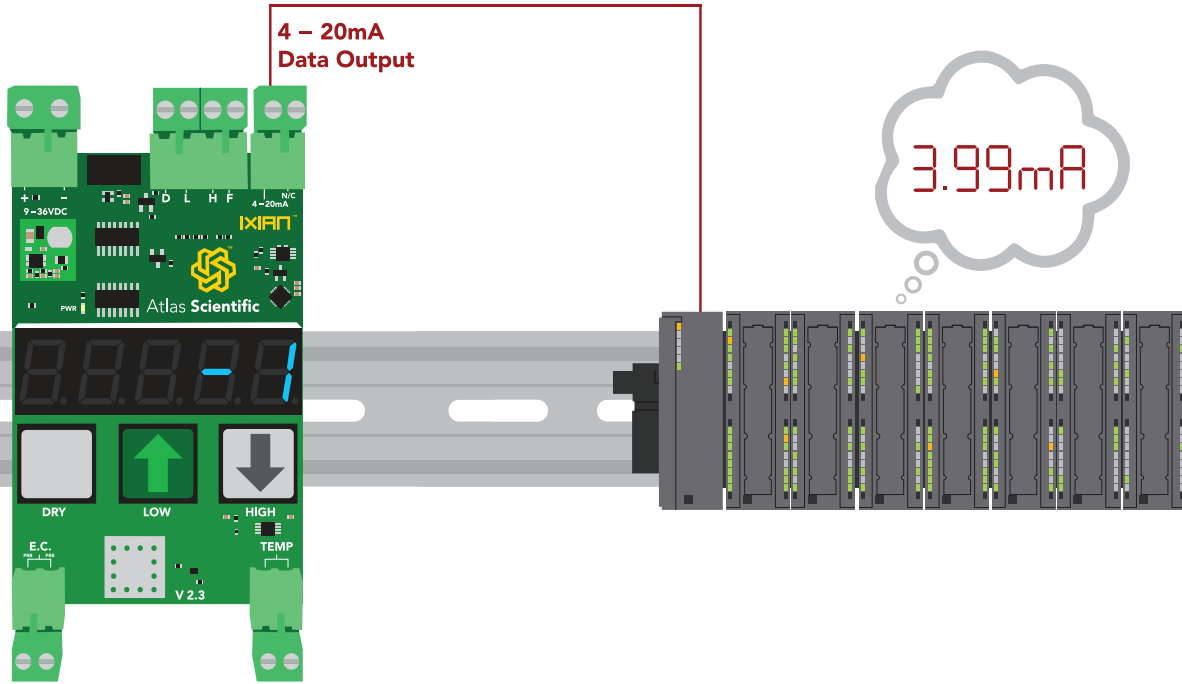



# Temperature compensation

To view the temperature that the IXIAN™ Conductivity Transmitter is reading from the attached PT-100, or PT-1000 temperature probe, press the **DRY** and **LOW** buttons simultaneously. The display will now show the temperature. It will continue to display the temperature for 10 seconds.

If a temperature probe is not connected, The IXIAN™ Conductivity Transmitter will use 25°C as the default temperature.

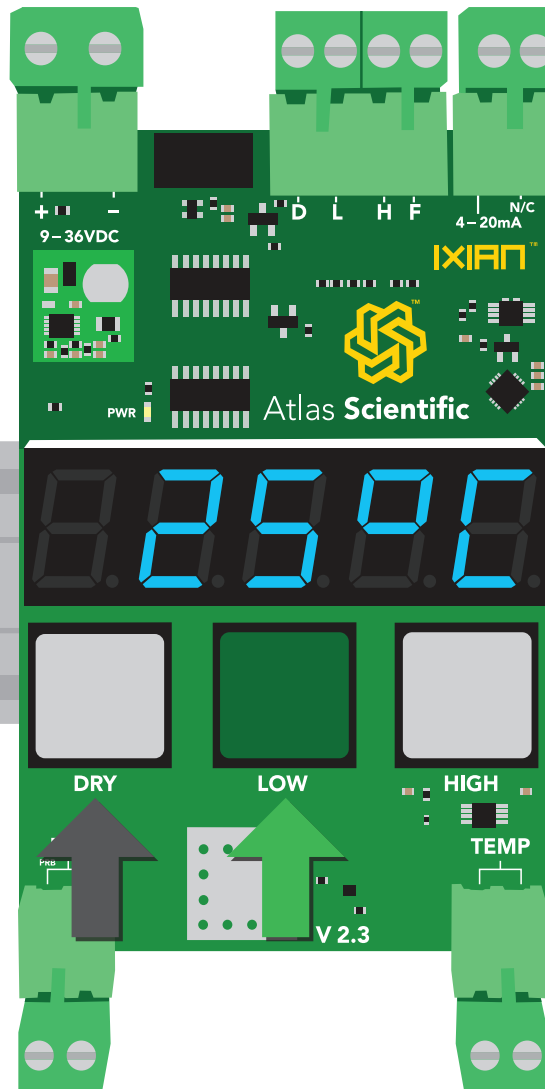

Temperature data cannot be output to PLC.

# Factory reset

The IXIAN™ Conductivity Transmitter can be reset to its default settings. To issue a factory reset, press and hold the **LOW** and **HIGH** buttons for three seconds.

The display will flash: *rESEt*



**3 seconds**

Press and hold the **LOW** and **HIGH** buttons again to confirm the factory reset. To cancel a factory reset, press the **DRY** button.

# How to smooth conductivity readings on the PLC side

Some PLCs will update its 4 – 20mA analog signal readings too quickly. This can give the appearance of a fluctuating conductivity reading. Although the fluctuations are small, it can make it difficult to determine what the conductivity actually is. One possible way stop this from happening is by making an IIR filter in software.

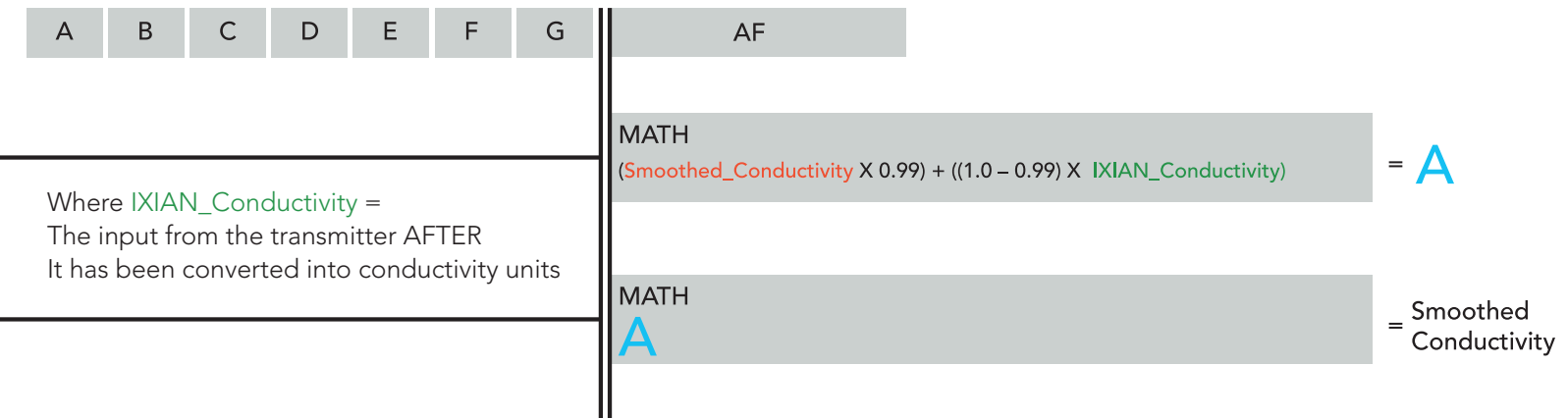

Both sections are needed to make this work.

## How to derive TDS/PPM from conductivity

Conductivity • 0.54 = TDS

# Datasheet change log

## Datasheet V 2.5

Revised artwork and added "Product update" on pg 3.

## Datasheet V 2.4

Revised Fault detect line information on pg 15.

## Datasheet V 2.3

Added 4 – 20mA max load resistance formula on pg 11.

## Datasheet V 2.2

Added how to Read the 4 – 20mA output with a multimeter on pg 12.

## Datasheet V 2.1

Added info about calibration data saved to EEPROM on pg 16.

## Datasheet V 2.0

Revised entire datasheet.