

OPTIONAL VOIDED CIRCUIT
SEE CHART FOR LOCATIONS

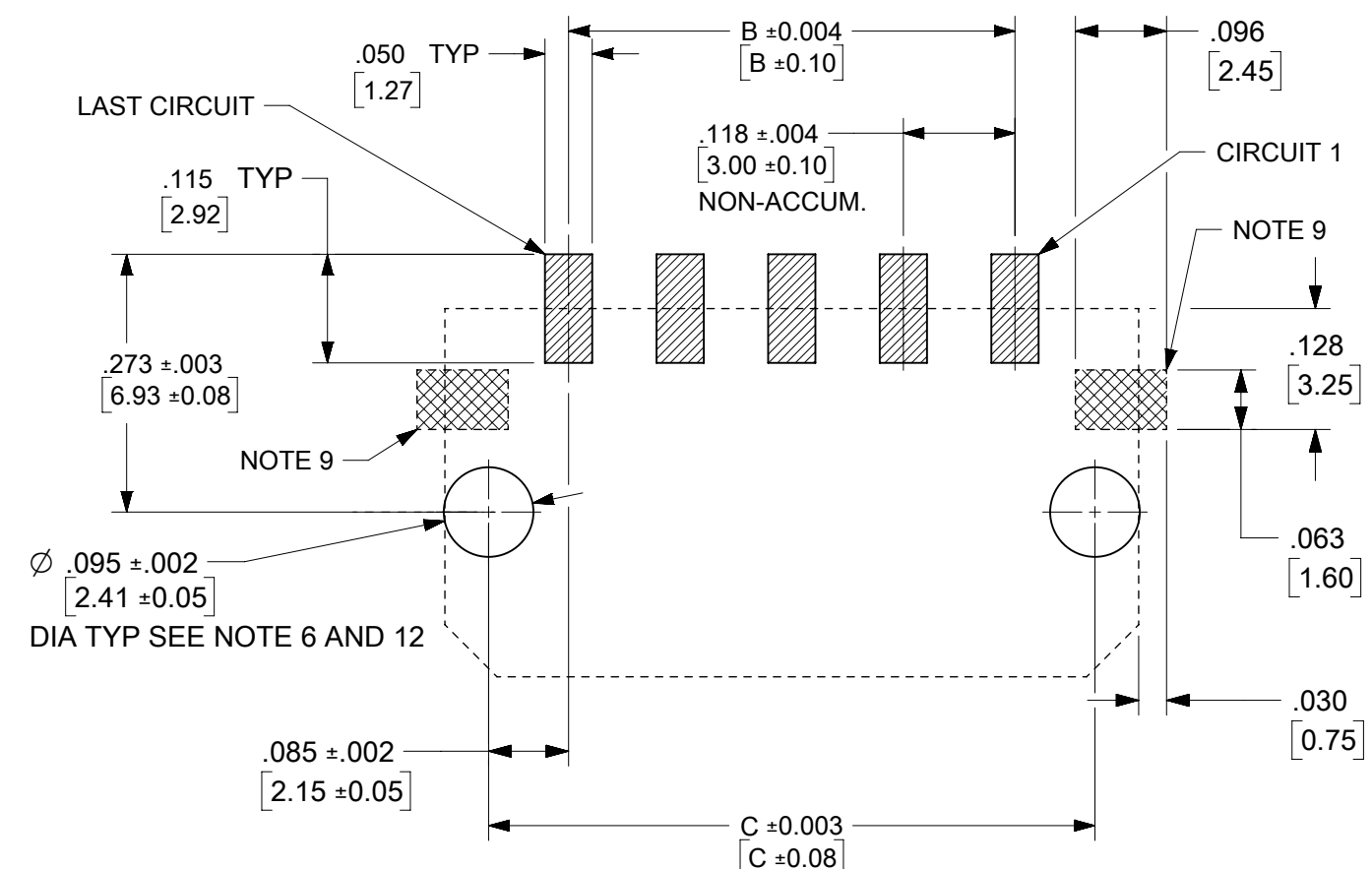

PCB LAYOUT: COMPONENT SIDE
RECOMMENDED PCB THICKNESS: .062/1.57

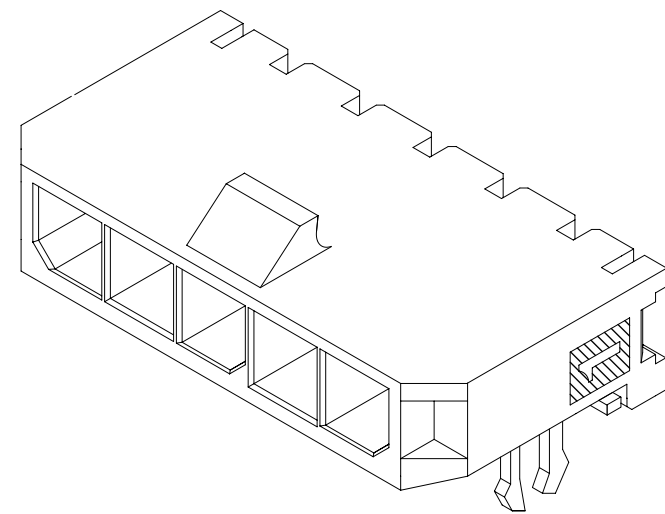
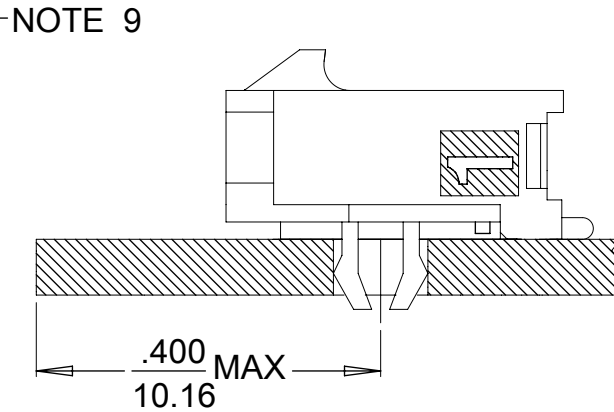
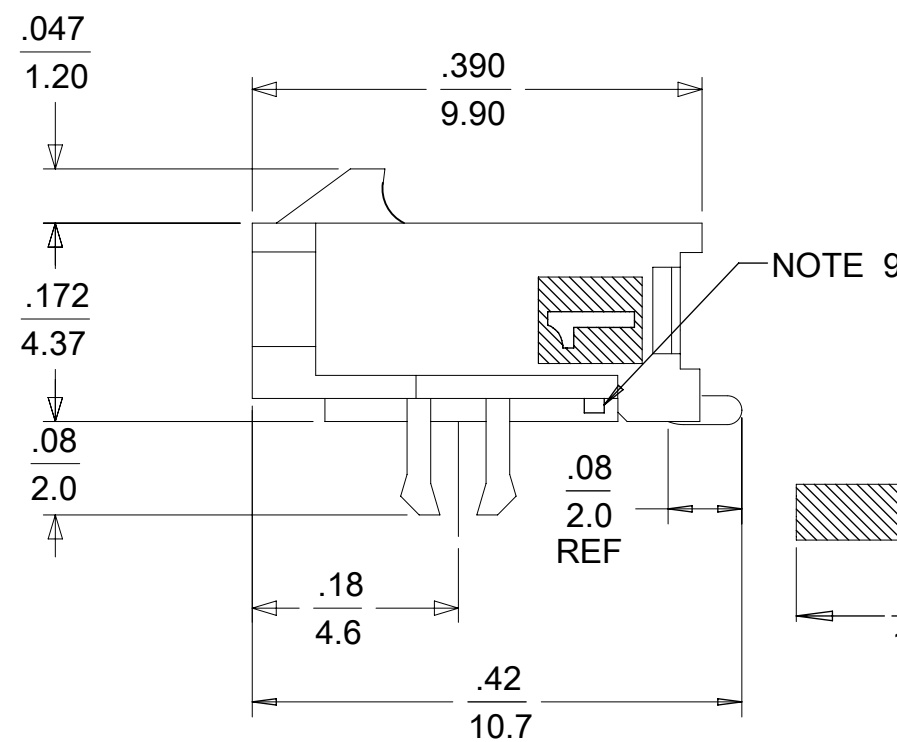
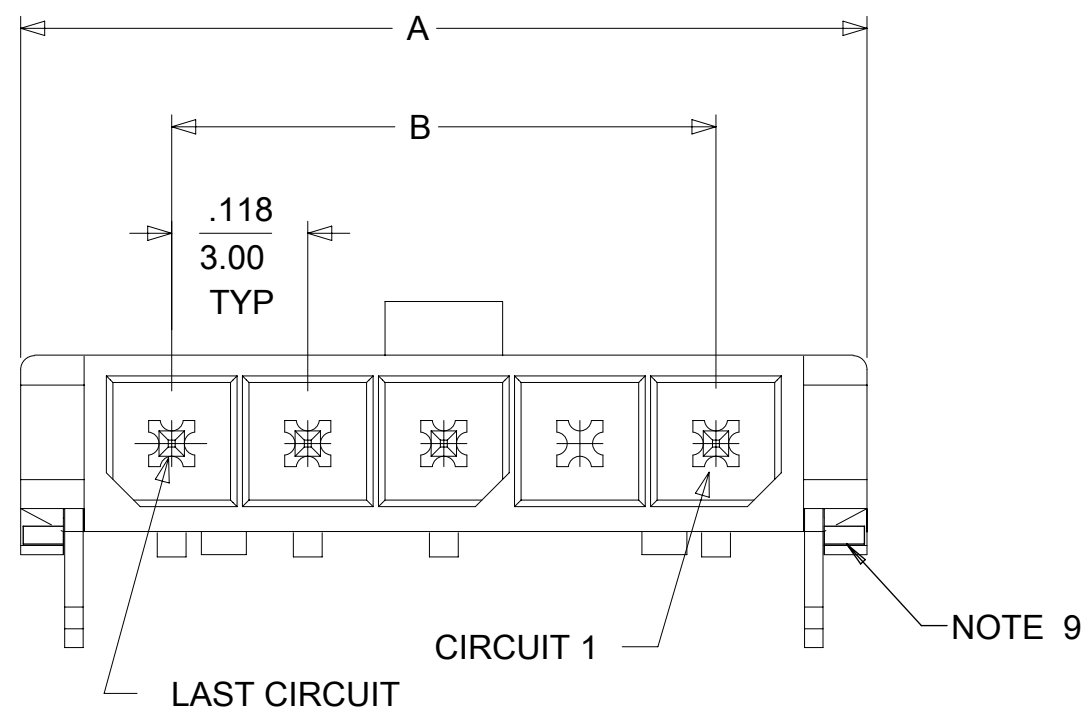

LOCATION DETAIL
SEE NOTE 8

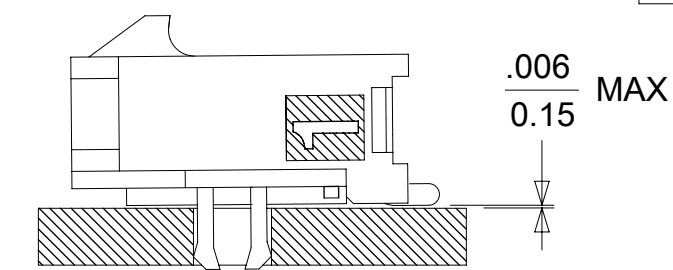

COPLANARITY DETAIL
SEE NOTE 7

CKTS	DIM A	DIM B	DIM C
2	.380 9.65	.118 3.00	.287 7.30
3	.498 12.65	.236 6.00	.405 10.30
4	.616 15.65	.354 9.00	.524 13.30
5	.734 18.64	.472 12.00	.642 16.30
6	.852 21.64	.591 15.00	.760 19.30
7	.970 24.64	.709 18.00	.878 22.30
8	1.088 27.64	.827 21.00	.996 25.30
9	1.206 30.63	.945 24.00	1.114 28.30
10	1.325 33.66	1.063 27.00	1.232 31.30
11	1.443 36.65	1.181 30.00	1.350 34.30
12	1.561 39.65	1.299 33.00	1.469 37.30

NOTES:

- HOUSING MATERIAL: LIQUID CRYSTAL POLYMER, GLASS FILLED, UL94V-0, COLOR: BLACK
TERMINAL MATERIAL: BRASS ALLOY
- FINISH:
A = .000060/(0.00152) MIN. REFLOWED MATTE TIN OVER
.000050/(0.00127) MIN. NICKEL
(FINISH IS BRIGHT IN APPEARANCE, THICKNESS AS APPLIED PRIOR TO REFLOW)
B = .000015/(0.00038) MIN. SELECT GOLD IN CONTACT AREA
.000100/(0.00254) MIN. SELECT MATTE TIN ON SOLDER TAILS
BOTH OVER .000050/(0.00127) NICKEL OVERALL
C = .000030/(0.00076) MIN. SELECT GOLD IN CONTACT AREA
.000100/(0.00254) MIN. SELECT MATTE TIN ON SOLDER TAILS
BOTH OVER .000050/(0.00127) NICKEL OVERALL
- PRODUCT SPECIFICATION: PS-43650
- TAPE & REEL PACKAGED PER MOLEX DRAWING 436500001-PK
- MATES WITH: RECEPTACLE NUMBER 43645
- TO MINIMIZE INSERTION FORCE ON MOUNTING CLIPS DURING ROBOTIC PLACEMENT, HOLE DIAMETER SPECIFICATIONS MUST BE INCREASED MAKING THEM MORE COMPATIBLE WITH PICK AND PLACE EQUIPMENT. HOLE DIAMETERS SHOULD BE INCREASED TO APPROXIMATELY .100±.002/(2.54±0.05) AND EVALUATED PER PLACEMENT EQUIPMENT.
- THE COPLANARITY DIMENSION IS ESTABLISHED BY PLACING THE ASSEMBLY ON A FLAT SURFACE. THE DISTANCE FROM THAT SURFACE TO THE BOTTOM OF ANY ANY TERMINAL MUST NOT EXCEED .006/0.15
- TO AVOID INTERFERENCE BETWEEN RECEPTACLE AND PCB, HEADER MUST BE PLACED WITHIN .400/(10.16) MAX. FROM EDGE OF PCB, AS SHOWN IN LOCATION DETAIL.
- METAL TAB MAY BE FLUSH WITH PCB. NO EXPOSED TRACES OR VIAS ALLOWED NEAR THESE AREAS.
- PARTS CONFORM TO CLASS 'B' REQUIREMENTS OF COSMETIC SPECIFICATION PS-45499-002.
- TEXT ON PART IS FOR REFERENCE ONLY. TEXT AND TEXT LOCATION MAY VARY DEPENDING ON PART NUMBER AND/OR TOOL.
- HOLES FOR CLIPS SHOULD BE PTH AND CLIPS SHOULD BE SOLDERED FOR BEST RETENTION TO PCB.

CKTS	FINISH A		FINISH B		FINISH C	
	MATERIAL NO:	VOID CKT	MATERIAL NO:	VOID CKT	MATERIAL NO:	VOID CKT
02	43650-0209		43650-0210		43650-0211	
03	43650-0309		43650-0310		43650-0311	
04	43650-0409		43650-0410		43650-0411	
05	43650-0509		43650-0510		43650-0511	
06	43650-0609		43650-0610		43650-0611	
07	43650-0709		43650-0710		43650-0711	
08	43650-0809		43650-0810		43650-0811	
09	43650-0909		43650-0910		43650-0911	
10	43650-1009		43650-1010		43650-1011	
11	43650-1109		43650-1110		43650-1111	
12	43650-1209		43650-1210		43650-1211	
03					43650-1311	02
04			43650-1410	02		

RECEPTACLE #43645

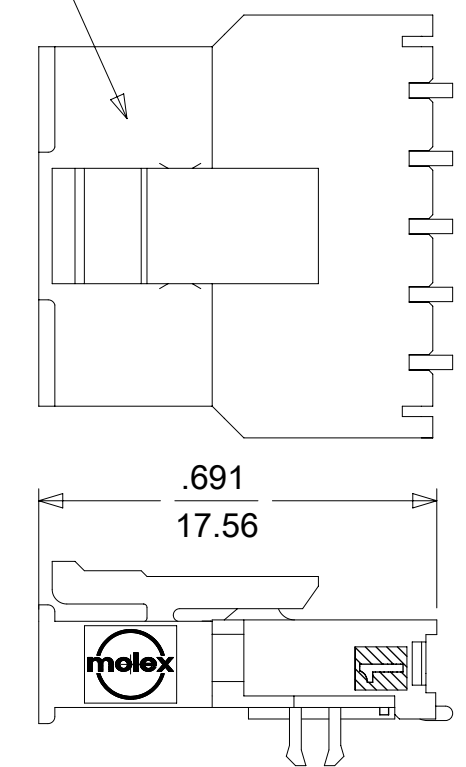

MATED MICRO FIT CONNECTORS

FUNCTIONAL SYMBOLS FA = 0 FC = 0 FP = 0	THIS DRAWING CONTAINS INFORMATION THAT IS PROPRIETARY TO MOLEX ELECTRONIC TECHNOLOGIES, LLC AND SHOULD NOT BE USED WITHOUT WRITTEN PERMISSION		CURRENT REV DESC: CORRECT INCH/MM DIMENSIONS IN PCB LAYOUT	
	DIMENSION UNITS: INCH/MM		SCALE: NTS	
	GENERAL TOLERANCES (UNLESS SPECIFIED)			
	4 PLACES ±		3 PLACES ± ± 0.01	
DIVISIONAL SYMBOLS	2 PLACES ± 0.25 ± 0.014		1 PLACE ± 0.36 ±	
	0 PLACES ±		ANGULAR TOL ± 0.5 °	
	DRAFT WHERE APPLICABLE MUST REMAIN WITHIN DIMENSIONS		THIRD ANGLE PROJECTION	
	DRAWING: C-SIZE		SERIES: 43650	
EC NO: 739185		2023/02/17		
DRWN: MKIPPER		2023/02/17		
CHK'D: MKIPPER		2023/02/17		
APPR: FSMITH		2023/02/17		
INITIAL REVISION:		2000/07/07		
DRWN: SAMIEC		2016/03/18		
APPR: FSMITH		2016/03/18		
DOCUMENT NUMBER		DOC TYPE		
SD-43650-004		PSD		
MATERIAL NUMBER		CUSTOMER		
SEE CHART		GENERAL MARKET		
DOC PART		REVISION		
000		E4		
SHEET NUMBER		1 OF 1		