

## STRADA-2X2-ME-WIDE2

Beam with excellent longitudinal luminance uniformity for staggered pole setups fulfilling EN13201 M-class requirements where road width is equal to or less than the pole height

### TECHNICAL SPECIFICATIONS:

Dimensions	50.0 x 50.0 mm
Height	7 mm
Fastening	pin, screw
ROHS compliant	yes ⓘ



### MATERIAL SPECIFICATIONS:

Component	Type	Material	Colour	Finish
STRADA-2X2-ME-WIDE2	Multi-lens	PMMA	clear	

### ORDERING INFORMATION:

Component	Qty in box	MOQ	MPQ	Box weight (kg)
C14165_STRADA-2X2-ME-WIDE2 » Box size: 480 x 280 x 300 mm	800	160	160	7.6

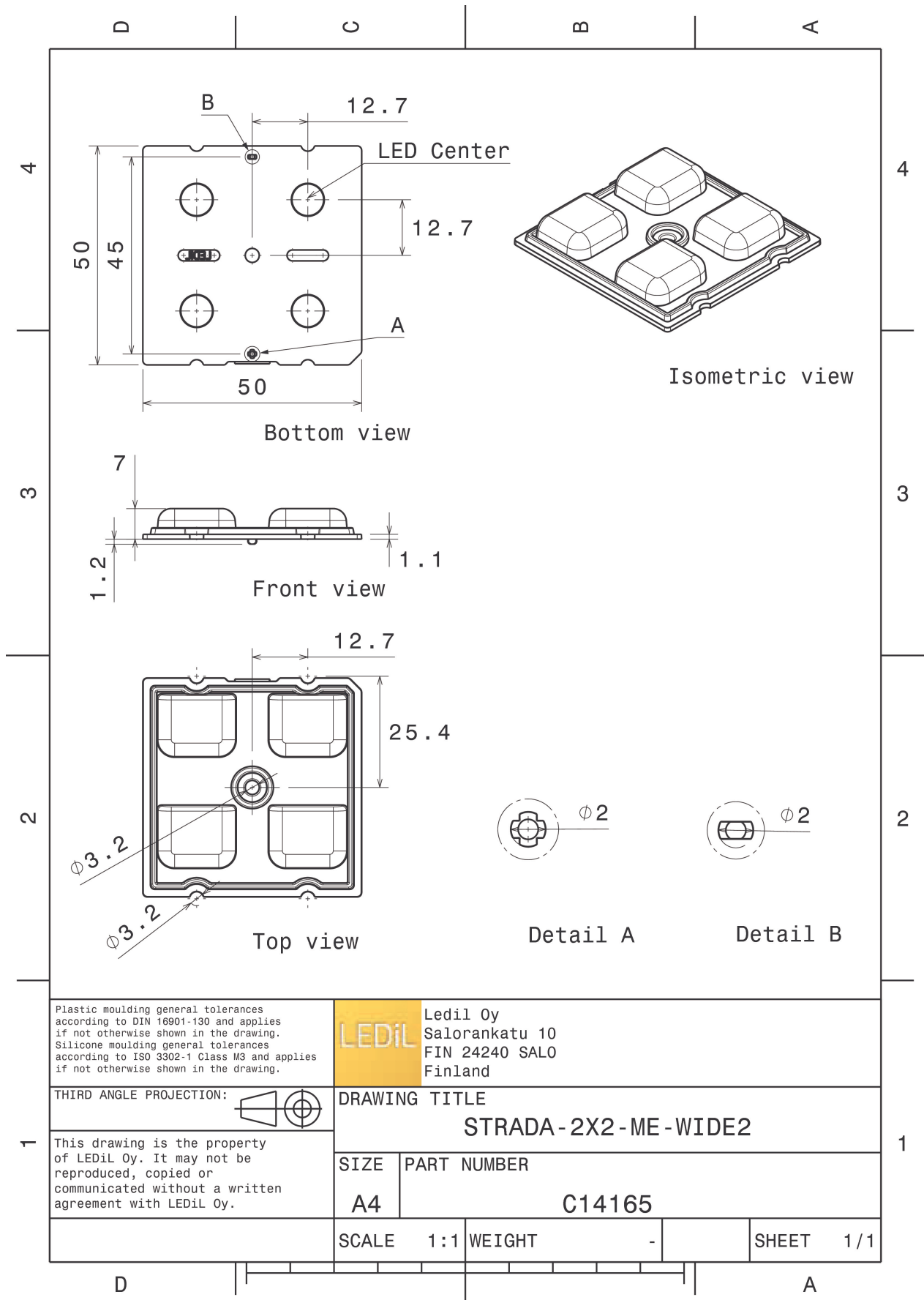

Plastic moulding general tolerances according to DIN 16901-130 and applies if not otherwise shown in the drawing. Silicone moulding general tolerances according to ISO 3302-1 Class M3 and applies if not otherwise shown in the drawing.

**LEDiL** Ledil Oy  
Salorankatu 10  
FIN 24240 SALO  
Finland

THIRD ANGLE PROJECTION:

DRAWING TITLE  
**STRADA - 2X2 - ME - WIDE2**

This drawing is the property of LEDiL Oy. It may not be reproduced, copied or communicated without a written agreement with LEDiL Oy.

SIZE	PART NUMBER
A4	C14165

SCALE	1:1	WEIGHT	-	SHEET	1/1
-------	-----	--------	---	-------	-----

See also our general installation guide: [www.ledil.com/installation\\_guide](http://www.ledil.com/installation_guide)

#### PHOTOMETRIC DATA (MEASURED):

**CREE** 

LED XD16  
 FWHM / FWTM Asymmetric  
 Efficiency 94 %  
 Peak intensity 0.6 cd/lm  
 LEDs/each optic 4  
 Light colour White  
 Required components:

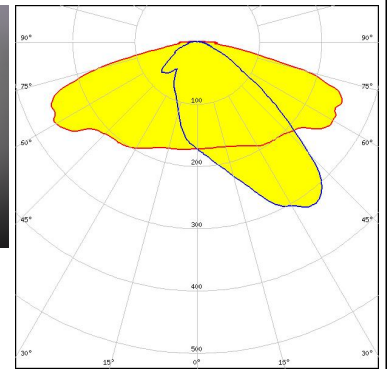
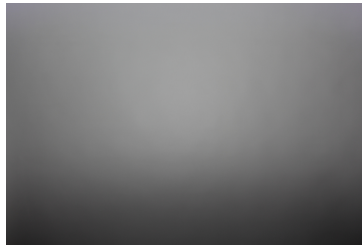

**CREE** 

LED XD16  
 FWHM / FWTM Asymmetric  
 Efficiency 94 %  
 Peak intensity 1.4 cd/lm  
 LEDs/each optic 1  
 Light colour White  
 Required components:

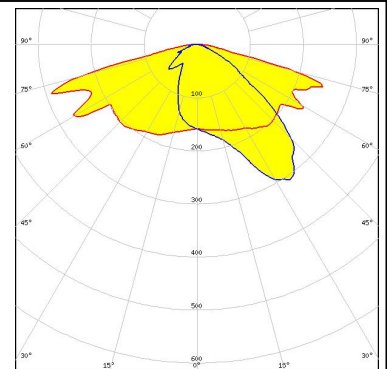

**CREE** 

LED XM-L3  
 FWHM / FWTM Asymmetric  
 Efficiency 96 %  
 Peak intensity 0.8 cd/lm  
 LEDs/each optic 1  
 Light colour White  
 Required components:

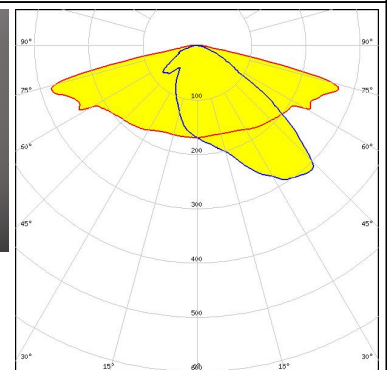

**CREE** 

LED XP-G2  
 FWHM / FWTM Asymmetric  
 Efficiency 79 %  
 Peak intensity 0.8 cd/lm  
 LEDs/each optic 1  
 Light colour White  
 Required components:

Protective plate, glass

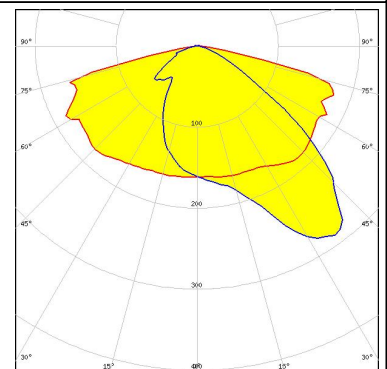

#### PHOTOMETRIC DATA (MEASURED):

**CREE** 

LED XP-G3  
 FWHM / FWTM Asymmetric  
 Efficiency 84 %  
 Peak intensity 0.7 cd/lm  
 LEDs/each optic 1  
 Light colour White  
 Required components:

Protective plate, glass

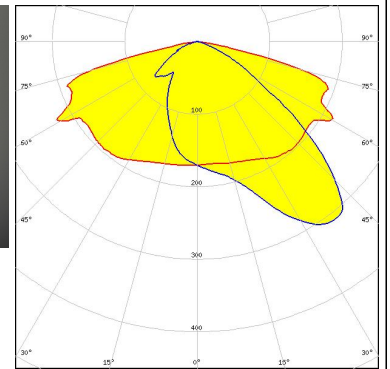

**CREE** 

LED XP-G3  
 FWHM / FWTM Asymmetric  
 Efficiency 87 %  
 Peak intensity 0.9 cd/lm  
 LEDs/each optic 1  
 Light colour White  
 Required components:  
 C17580\_STRADA-2X2-SHD-WHT

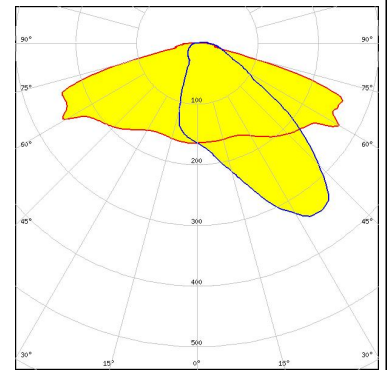

**CREE** 

LED XP-G3  
 FWHM / FWTM Asymmetric  
 Efficiency 72 %  
 Peak intensity 0.8 cd/lm  
 LEDs/each optic 1  
 Light colour White  
 Required components:  
 C17677\_STRADA-2X2-SHD-BLK

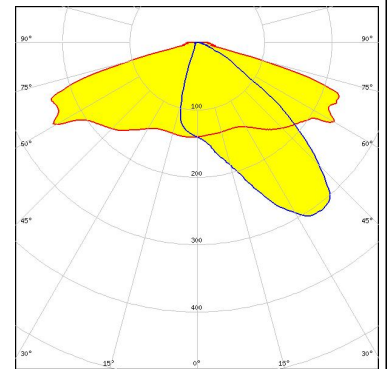

**CREE** 

LED XP-L2  
 FWHM / FWTM Asymmetric  
 Efficiency 83 %  
 Peak intensity 0.5 cd/lm  
 LEDs/each optic 1  
 Light colour White  
 Required components:

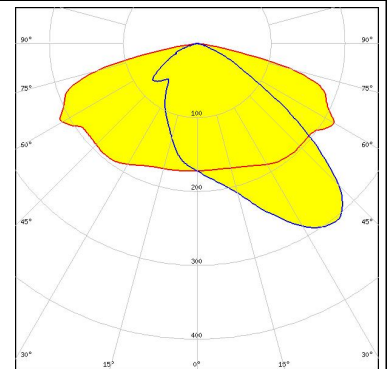

#### PHOTOMETRIC DATA (MEASURED):

#### LUMILEDS

LED LUXEON V  
 FWHM / FWTM Asymmetric  
 Efficiency 94 %  
 Peak intensity 0.6 cd/lm  
 LEDs/each optic 1  
 Light colour White  
 Required components:

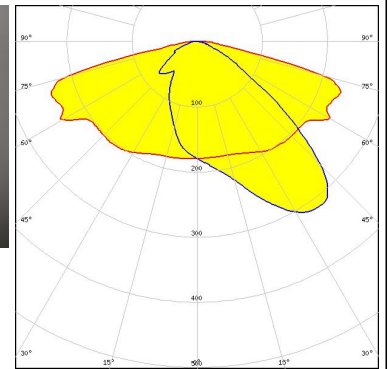

#### MST Your solutions

LED RecLED 122x50mm 1900lm 730 2x4 Opt G1  
 FWHM / FWTM Asymmetric  
 Efficiency 95 %  
 Peak intensity 1.1 cd/lm  
 LEDs/each optic 1  
 Light colour White  
 Required components:

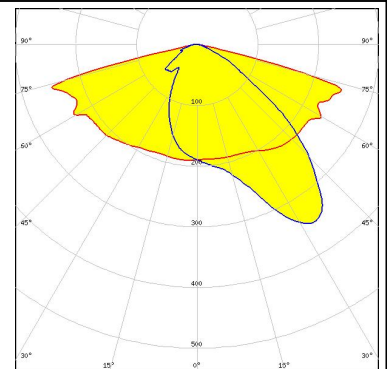

#### NICHIA

LED NVSW219F  
 FWHM / FWTM Asymmetric  
 Efficiency 94 %  
 Peak intensity 0.9 cd/lm  
 LEDs/each optic 1  
 Light colour White  
 Required components:

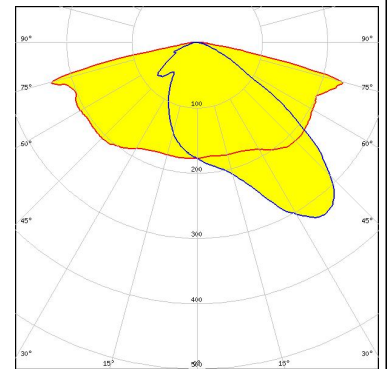

#### NICHIA

LED NVSW319B  
 FWHM / FWTM Asymmetric  
 Efficiency 94 %  
 Peak intensity 0.9 cd/lm  
 LEDs/each optic 1  
 Light colour White  
 Required components:

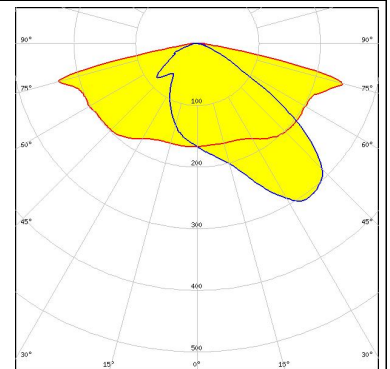

#### PHOTOMETRIC DATA (MEASURED):

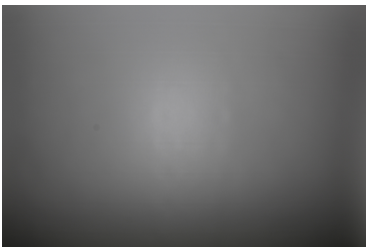
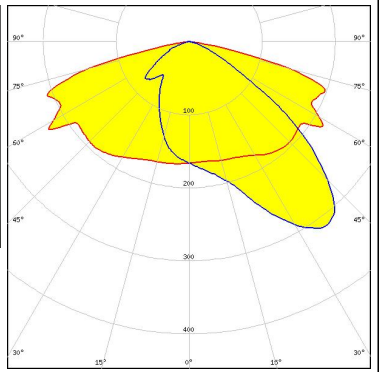
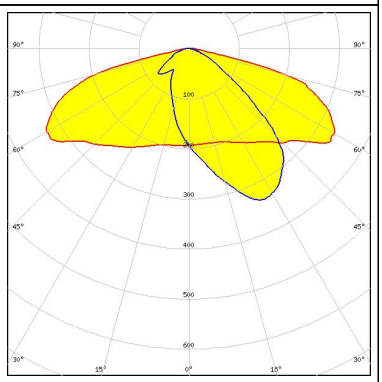
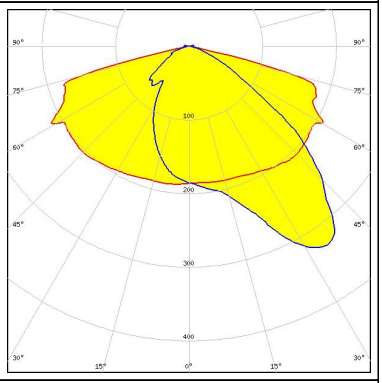
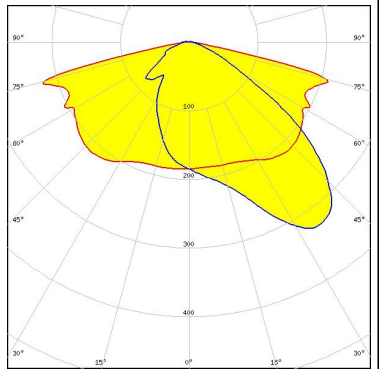
<p><b>NICHIA</b></p> <p>LED NVSW3x9A            FWHM / FWTM Asymmetric            Efficiency 85 %            Peak intensity 0.7 cd/lm            LEDs/each optic 1            Light colour White            Required components:</p>		
<p><b>OSRAM</b>  <small>Opto Semiconductors</small></p> <p>LED Duris S8            FWHM / FWTM Asymmetric            Efficiency 97 %            Peak intensity 0.5 cd/lm            LEDs/each optic 1            Light colour White            Required components:</p>		
<p><b>PHILIPS</b></p> <p>LED Fortimo FastFlex LED 2x8 DA G4            FWHM / FWTM Asymmetric            Efficiency 86 %            Peak intensity 0.9 cd/lm            LEDs/each optic 1            Light colour White            Required components:</p> <p>Protective plate, glass</p>		
<p><b>PHILIPS</b></p> <p>LED Fortimo FastFlex LED 2x8 DA G4+            FWHM / FWTM Asymmetric            Efficiency 94 %            Peak intensity 0.8 cd/lm            LEDs/each optic 1            Light colour White            Required components:</p>		

#### PHOTOMETRIC DATA (MEASURED):

### PHILIPS

LED Fortimo FastFlex LED 2x8 DAX G4  
 FWHM / FWTM Asymmetric  
 Efficiency 84 %  
 Peak intensity 0.7 cd/m  
 LEDs/each optic 1  
 Light colour White  
 Required components:

Protective plate, glass

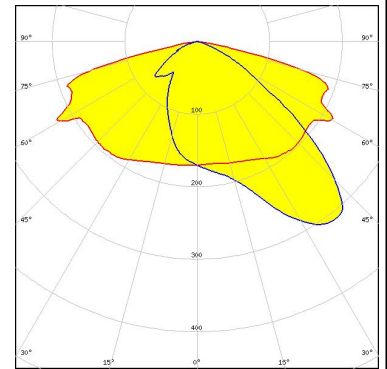

### SAMSUNG

LED HiLOM RC12 Z (LH181B)  
 FWHM / FWTM Asymmetric  
 Efficiency 99 %  
 Peak intensity 1.2 cd/m  
 LEDs/each optic 1  
 Light colour White  
 Required components:

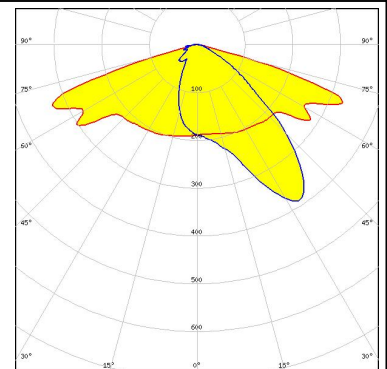

### SAMSUNG

LED HiLOM RH12 Z (LH351C)  
 FWHM / FWTM Asymmetric  
 Efficiency 97 %  
 Peak intensity 0.9 cd/m  
 LEDs/each optic 1  
 Light colour White  
 Required components:

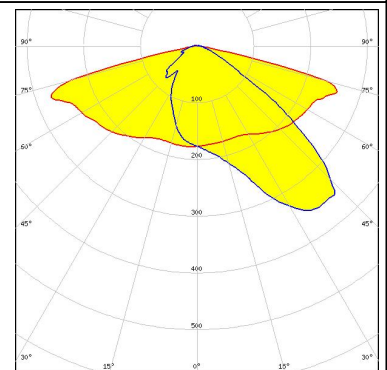

### SAMSUNG

LED HiLOM RH16 (LH351C)  
 FWHM / FWTM Asymmetric  
 Efficiency 94 %  
 Peak intensity 0.8 cd/m  
 LEDs/each optic 1  
 Light colour White  
 Required components:

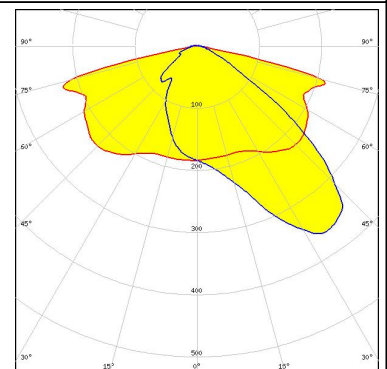

#### PHOTOMETRIC DATA (MEASURED):

### SAMSUNG

LED HiLOM RM12 Z (LH502C)  
FWHM / FWTM Asymmetric  
Efficiency 97 %  
Peak intensity 0.5 cd/lm  
LEDs/each optic 1  
Light colour White  
Required components:

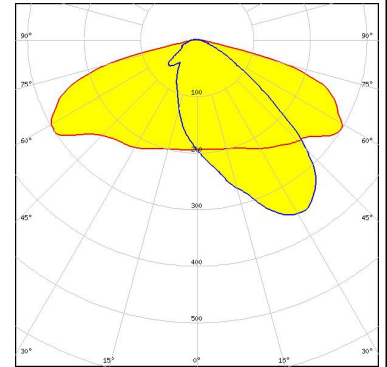

### SAMSUNG

LED HiLOM RM16 Z (LH502C)  
FWHM / FWTM Asymmetric  
Efficiency 98 %  
Peak intensity 0.6 cd/lm  
LEDs/each optic 1  
Light colour White  
Required components:

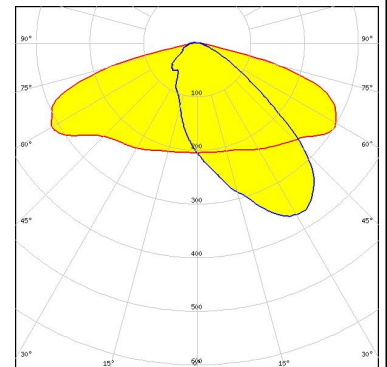

### SAMSUNG

LED HiLOM RM8 Z (LH502C)  
FWHM / FWTM Asymmetric  
Efficiency 97 %  
Peak intensity 0.5 cd/lm  
LEDs/each optic 1  
Light colour White  
Required components:

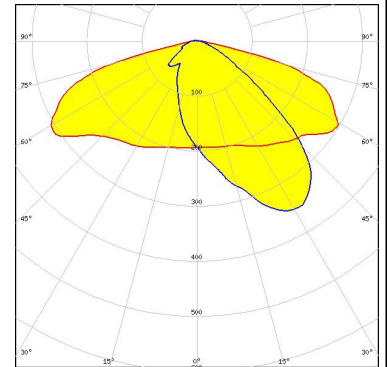





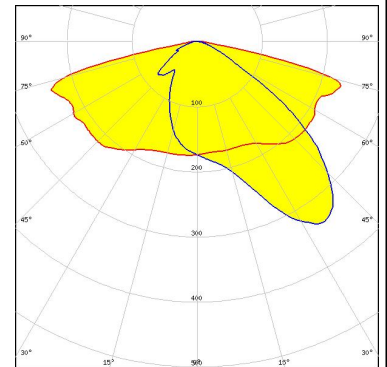

### SAMSUNG

LED LH351B  
FWHM / FWTM Asymmetric  
Efficiency 94 %  
Peak intensity 0.9 cd/lm  
LEDs/each optic 1  
Light colour White  
Required components:



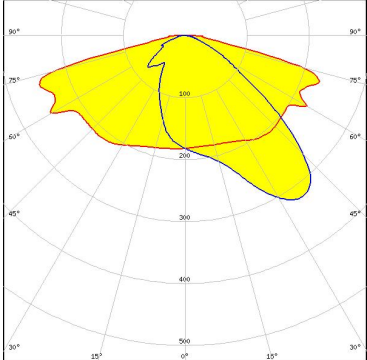

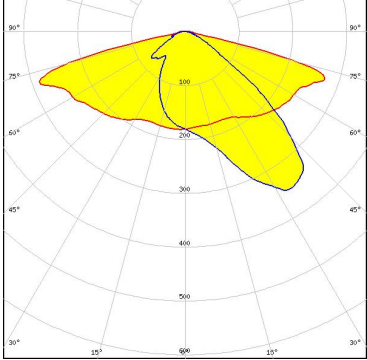
#### PHOTOMETRIC DATA (MEASURED):

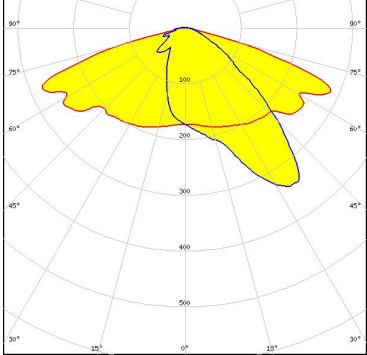
	<p>LED LED-Pa-L15c2W11c2-xxx-C050-01</p> <p>FWHM / FWTM Asymmetric</p> <p>Efficiency 97 %</p> <p>Peak intensity 1.1 cd/lm</p> <p>LEDs/each optic 1</p> <p>Light colour White</p> <p>Required components:</p>	
	<p>LED Z5M3</p> <p>FWHM / FWTM Asymmetric</p> <p>Efficiency 94 %</p> <p>Peak intensity 0.9 cd/lm</p> <p>LEDs/each optic 1</p> <p>Light colour White</p> <p>Required components:</p>	
	<p>LED Z5M4</p> <p>FWHM / FWTM Asymmetric</p> <p>Efficiency 97 %</p> <p>Peak intensity 0.9 cd/lm</p> <p>LEDs/each optic 1</p> <p>Light colour White</p> <p>Required components:</p>	
	<p>LED Z8Y22</p> <p>FWHM / FWTM Asymmetric</p> <p>Efficiency 94 %</p> <p>Peak intensity 0.9 cd/lm</p> <p>LEDs/each optic 1</p> <p>Light colour White</p> <p>Required components:</p>	

### PHOTOMETRIC DATA (MEASURED):

#### TOSHIBA

Leading Innovation >>>

LED TL1L4  
FWHM / FWTM Asymmetric  
Efficiency 81 %  
Peak intensity 0.8 cd/lm  
LEDs/each optic 1  
Light colour White  
Required components:

Protective plate, glass

#### TRIDONIC

LED RLE 2x4 2000lm HP EXC2 OTD  
FWHM / FWTM Asymmetric  
Efficiency 94 %  
Peak intensity 1.3 cd/lm  
LEDs/each optic 1  
Light colour White  
Required components:

#### TRIDONIC

LED RLE 2x8 4000lm HP EXC2 OTD  
FWHM / FWTM Asymmetric  
Efficiency 94 %  
Peak intensity 1.3 cd/lm  
LEDs/each optic 1  
Light colour White  
Required components:

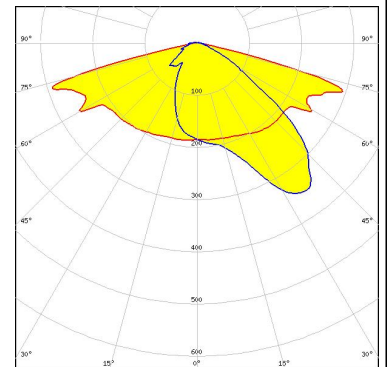

#### TRIDONIC

LED RLE G1 49x121mm 2000lm xxx EXC OTD  
FWHM / FWTM Asymmetric  
Efficiency 94 %  
Peak intensity 1.3 cd/lm  
LEDs/each optic 1  
Light colour White  
Required components:

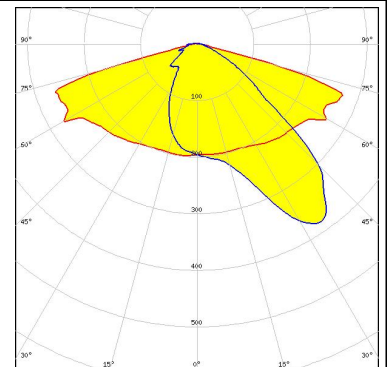

#### PHOTOMETRIC DATA (MEASURED):

#### TRIDONIC

LED RLE G1 49x133mm 2000lm xxx EXC OTD  
FWHM / FWTM Asymmetric  
Efficiency 94 %  
Peak intensity 1.3 cd/lm  
LEDs/each optic 1  
Light colour White  
Required components:

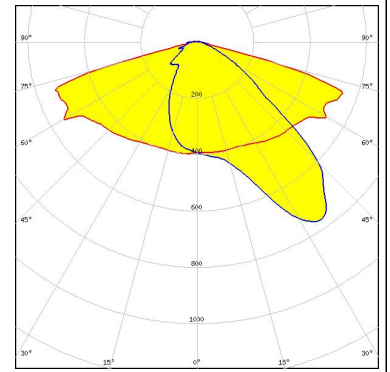

#### TRIDONIC

LED RLE G1 49x223mm 4000lm xxx EXC OTD  
FWHM / FWTM Asymmetric  
Efficiency 94 %  
Peak intensity 1.3 cd/lm  
LEDs/each optic 1  
Light colour White  
Required components:

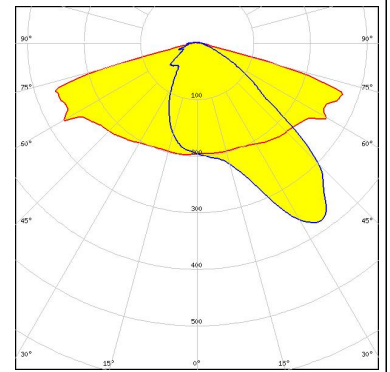

#### TRIDONIC

LED RLE G1 49x245mm 4000lm xxx EXC OTD  
FWHM / FWTM Asymmetric  
Efficiency 94 %  
Peak intensity 1.3 cd/lm  
LEDs/each optic 1  
Light colour White  
Required components:

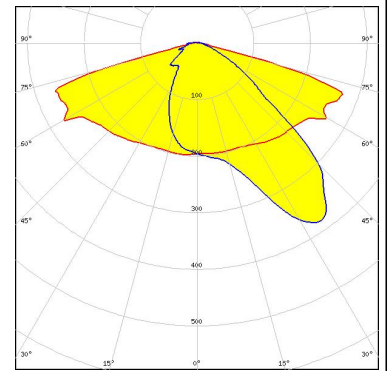

#### PHOTOMETRIC DATA (SIMULATED):



LED XHP35 HD  
 FWHM / FWTM Asymmetric  
 Efficiency 94 %  
 Peak intensity 0.5 cd/lm  
 LEDs/each optic 1  
 Light colour White  
 Required components:

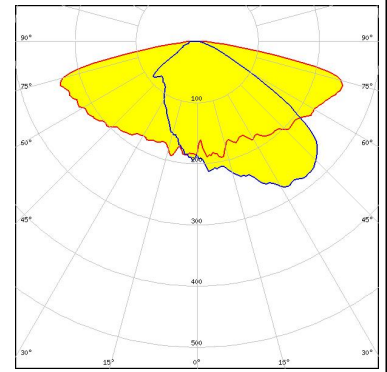

LED XP-G2 HE  
 FWHM / FWTM Asymmetric  
 Efficiency 92 %  
 Peak intensity 0.7 cd/lm  
 LEDs/each optic 1  
 Light colour White  
 Required components:

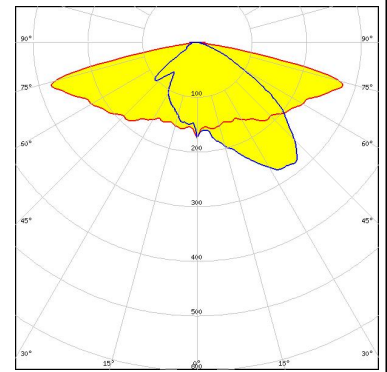

LED XP-G3  
 FWHM / FWTM Asymmetric  
 Efficiency 73 %  
 Peak intensity 0.6 cd/lm  
 LEDs/each optic 1  
 Light colour White  
 Required components:  
 C17580\_STRADA-2X2-SHD-WHT

Protective plate, glass

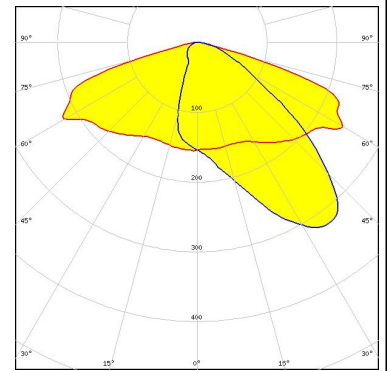

LED XP-L HD  
 FWHM / FWTM Asymmetric  
 Efficiency 90 %  
 Peak intensity 0.7 cd/lm  
 LEDs/each optic 1  
 Light colour White  
 Required components:

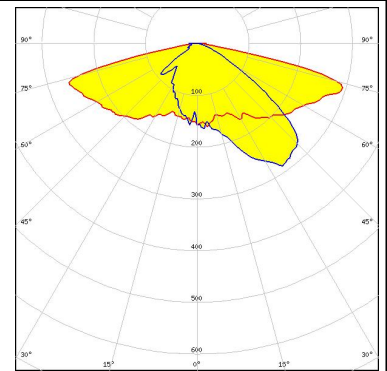

#### PHOTOMETRIC DATA (SIMULATED):



LED XP-L2  
 FWHM / FWTM Asymmetric  
 Efficiency 80 %  
 Peak intensity 0.4 cd/lm  
 LEDs/each optic 1  
 Light colour White  
 Required components:

Protective plate, glass

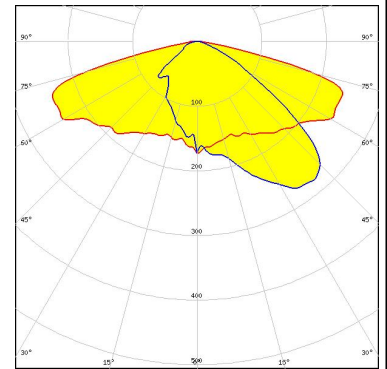

LED XT-E  
 FWHM / FWTM Asymmetric  
 Efficiency 80 %  
 Peak intensity 0.7 cd/lm  
 LEDs/each optic 1  
 Light colour White  
 Required components:

Protective plate, glass

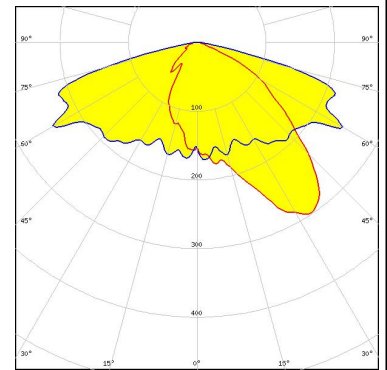

LED LUXEON 5050 Round LES  
 FWHM / FWTM Asymmetric  
 Efficiency 84 %  
 Peak intensity 0.5 cd/lm  
 LEDs/each optic 1  
 Light colour White  
 Required components:

Protective plate, glass

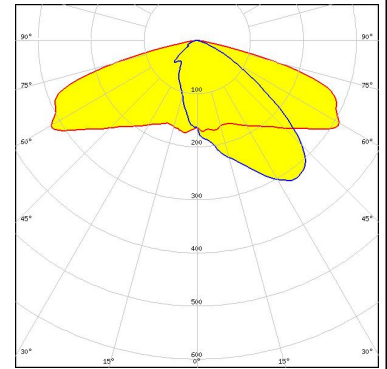

LED LUXEON 5050 Round LES  
 FWHM / FWTM Asymmetric  
 Efficiency 94 %  
 Peak intensity 0.6 cd/lm  
 LEDs/each optic 1  
 Light colour White  
 Required components:

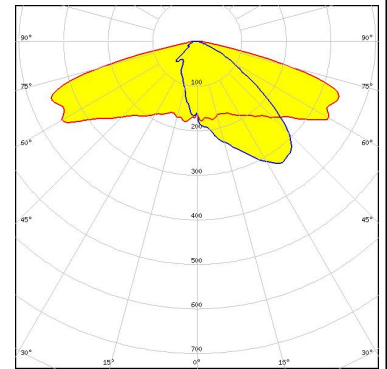

#### PHOTOMETRIC DATA (SIMULATED):

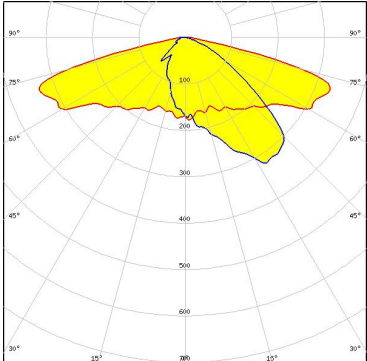
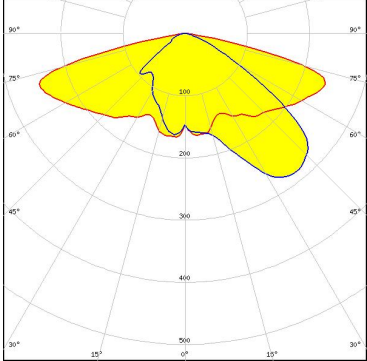
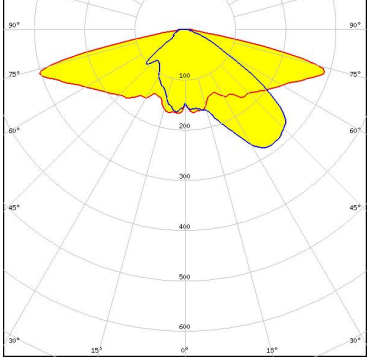
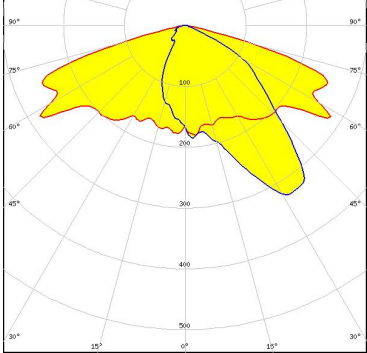
<p><b>NICHIA</b></p> <p>LED: NV4WB35AM            FWHM / FWTM: Asymmetric            Efficiency: 95 %            Peak intensity: 0.6 cd/lm            LEDs/each optic: 1            Light colour: White            Required components:</p>	
<p><b>NICHIA</b></p> <p>LED: NVSW519A            FWHM / FWTM: Asymmetric            Efficiency: 82 %            Peak intensity: 0.4 cd/lm            LEDs/each optic: 1            Light colour: White            Required components:</p> <p style="background-color: #ADD8E6; padding: 2px; display: inline-block;">Protective plate, glass</p>	
<p><b>NICHIA</b></p> <p>LED: NVSW519A            FWHM / FWTM: Asymmetric            Efficiency: 92 %            Peak intensity: 0.6 cd/lm            LEDs/each optic: 1            Light colour: White            Required components:</p>	
<p><b>NICHIA</b></p> <p>LED: NVSxE21A            FWHM / FWTM: Asymmetric            Efficiency: 82 %            Peak intensity: 0.7 cd/lm            LEDs/each optic: 1            Light colour: White            Required components:</p> <p style="background-color: #ADD8E6; padding: 2px; display: inline-block;">Protective plate, glass</p>	

#### PHOTOMETRIC DATA (SIMULATED):

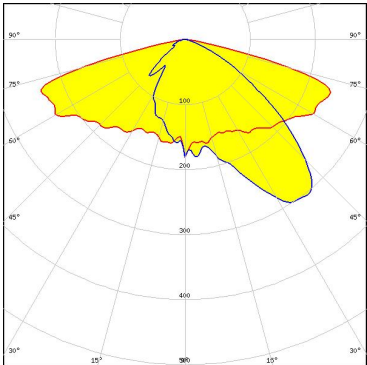
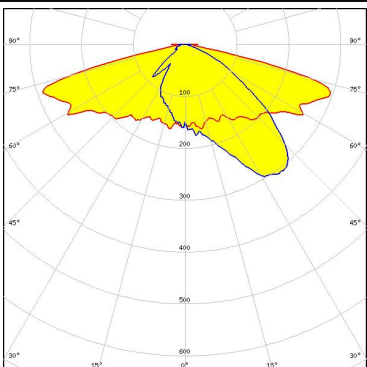
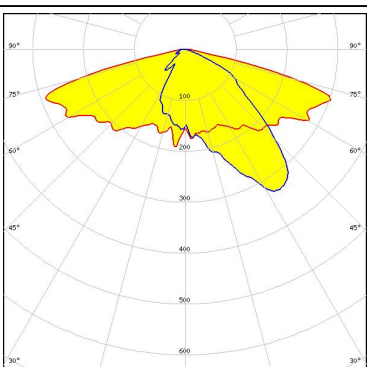
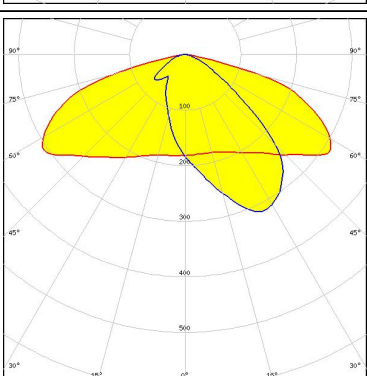
<p><b>NICHIA</b></p> <p>LED: NVSxx19B/NVSxx19C            FWHM / FWTM: Asymmetric            Efficiency: 81 %            Peak intensity: 0.6 cd/lm            LEDs/each optic: 1            Light colour: White            Required components:            Protective plate, glass</p>	
<p><b>NICHIA</b></p> <p>LED: NVSxx19B/NVSxx19C            FWHM / FWTM: Asymmetric            Efficiency: 94 %            Peak intensity: 0.9 cd/lm            LEDs/each optic: 1            Light colour: White            Required components:</p>	
<p><b>OSRAM</b></p> <p>LED: PrevaLED Brick HP 2x8            FWHM / FWTM: Asymmetric            Efficiency: 92 %            Peak intensity: 0.9 cd/lm            LEDs/each optic: 1            Light colour: White            Required components:</p>	
<p><b>OSRAM</b>  <small>Opto Semiconductors</small></p> <p>LED: Duris S8            FWHM / FWTM: Asymmetric            Efficiency: 83 %            Peak intensity: 0.4 cd/lm            LEDs/each optic: 1            Light colour: White            Required components:            Protective plate, glass</p>	

#### PHOTOMETRIC DATA (SIMULATED):

##### OSRAM

Opto Semiconductors

LED OSCONIQ P 3737 (2W version)  
 FWHM / FWTM Asymmetric  
 Efficiency 94 %  
 Peak intensity 1 cd/lm  
 LEDs/each optic 1  
 Light colour White  
 Required components:

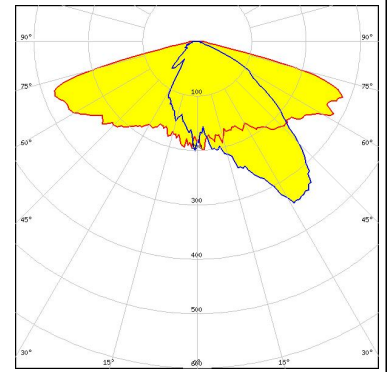

##### OSRAM

Opto Semiconductors

LED OSCONIQ P 3737 (3W version)  
 FWHM / FWTM Asymmetric  
 Efficiency 94 %  
 Peak intensity 0.6 cd/lm  
 LEDs/each optic 1  
 Light colour White  
 Required components:

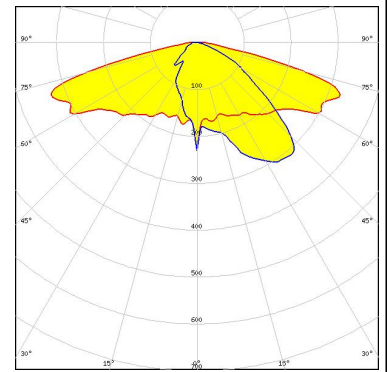

##### OSRAM

Opto Semiconductors

LED OSCONIQ P 3737 (3W version)  
 FWHM / FWTM Asymmetric  
 Efficiency 81 %  
 Peak intensity 0.5 cd/lm  
 LEDs/each optic 1  
 Light colour White  
 Required components:

Protective plate, glass

##### OSRAM

Opto Semiconductors

LED OSLON Square CSSRM2/CSSRM3  
 FWHM / FWTM Asymmetric  
 Efficiency 92 %  
 Peak intensity 0.9 cd/lm  
 LEDs/each optic 1  
 Light colour White  
 Required components:

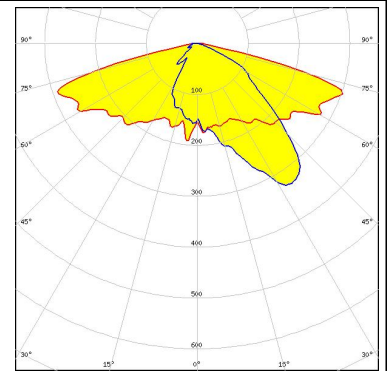



#### PHOTOMETRIC DATA (SIMULATED):

#### OSRAM

Opto Semiconductors

LED OSLON Square CSSRM2/CSSRM3  
 FWHM / FWTM Asymmetric  
 Efficiency 82 %  
 Peak intensity 0.6 cd/lm  
 LEDs/each optic 1  
 Light colour White  
 Required components:

Protective plate, glass

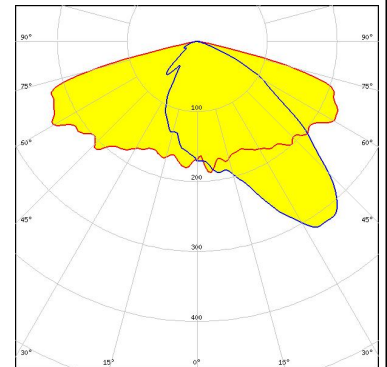

#### OSRAM

Opto Semiconductors

LED OSLON Square CSSRM2/CSSRM3  
 FWHM / FWTM Asymmetric  
 Efficiency 79 %  
 Peak intensity 0.5 cd/lm  
 LEDs/each optic 1  
 Light colour White  
 Required components:

Protective plate, glass

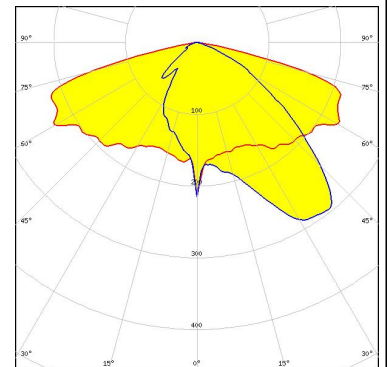

#### SAMSUNG

LED HiLOM RH12 Z (LH351C)  
 FWHM / FWTM Asymmetric  
 Efficiency 82 %  
 Peak intensity 0.6 cd/lm  
 LEDs/each optic 1  
 Light colour White  
 Required components:

Protective plate, glass

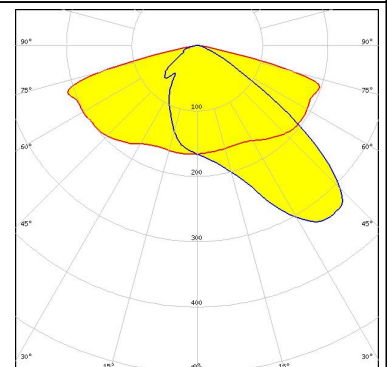

#### SAMSUNG

LED LH351D  
 FWHM / FWTM Asymmetric  
 Efficiency 75 %  
 Peak intensity 0.4 cd/lm  
 LEDs/each optic 1  
 Light colour White  
 Required components:

Protective plate, glass

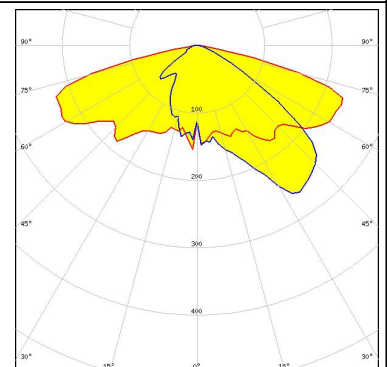

#### PHOTOMETRIC DATA (SIMULATED):

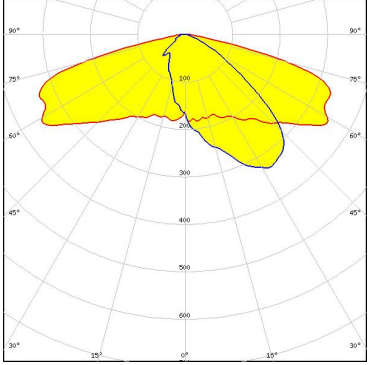
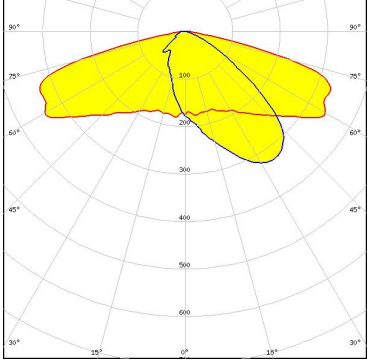
 SEOUL SEMICONDUCTOR	LED MJT 5050	
	FWHM / FWTM Asymmetric	
	Efficiency 95 %	
	Peak intensity 0.5 cd/lm	
	LEDs/each optic 1	
	Light colour White	
	Required components:	
 SEOUL SEMICONDUCTOR	LED SEOUL DC 5050 6V	
	FWHM / FWTM Asymmetric	
	Efficiency 95 %	
	Peak intensity 0.5 cd/lm	
	LEDs/each optic 1	
	Light colour White	
	Required components:	

#### GENERAL INFORMATION:

NOTE: The typical beam angle will be changed by different color, chip size and chip position tolerance. The typical total beam angle is the full angle measured where the luminous intensity is half of the peak value.

#### MATERIALS:

As part of our continuous research and improvement processes, and to ensure the best possible quality and availability of our products, LEDiL reserves the right to change material grades without notice.

#### PRODUCT DATA USER AGREEMENT AND DISCLAIMER:

The measured data in the provided downloadable LEDiL Product Datasheets and Mechanical 2D-Drawings is rounded and provided as reference for planning. LEDiL Oy's optical specifications have been verified by conducting performance testing of the products in accordance with the company's quality system. The reported data are averaged results of multiple measurements with typical variation. LEDiL Oy reserves the right to without prior notification make changes and improvements to its products.

LEDiL Oy assumes neither warranty, nor guarantee nor any other liability of any kind for the contents and correctness of the provided data. The provided data has been generated with highest diligence but the provided data may in reality not represent the complete possible variation range of all intrinsic parameters. Therefore, in certain cases a deviation from the provided data could occur.

LEDiL Oy reserves the right to undertake technical changes of its products without further notification which could lead to changes in the provided data. LEDiL Oy assumes no liability of any kind for the possible deviation from any provided data or any other damage resulting from the usage of the provided data.

The user agrees to this disclaimer and user agreement with the download or usage of the provided files.

#### LEDiL Oy

Joensuunkatu 13  
FI-24240 SALO  
Finland

#### LEDiL Inc.

228 West Page Street  
Suite D  
Sycamore IL 60178  
USA

#### Ledil Optics Technology (Shenzhen) Co., Ltd.

# 405 , Block B  
Casic Motor Building  
Shenzhen 518057  
P.R.CHINA

#### Local sales and technical support

[www.ledil.com/  
where\\_to\\_buy](http://www.ledil.com/where_to_buy)

#### Shipping locations

Salo, Finland  
Hong Kong, China

#### Distribution Partners

[www.ledil.com/  
where\\_to\\_buy](http://www.ledil.com/where_to_buy)