

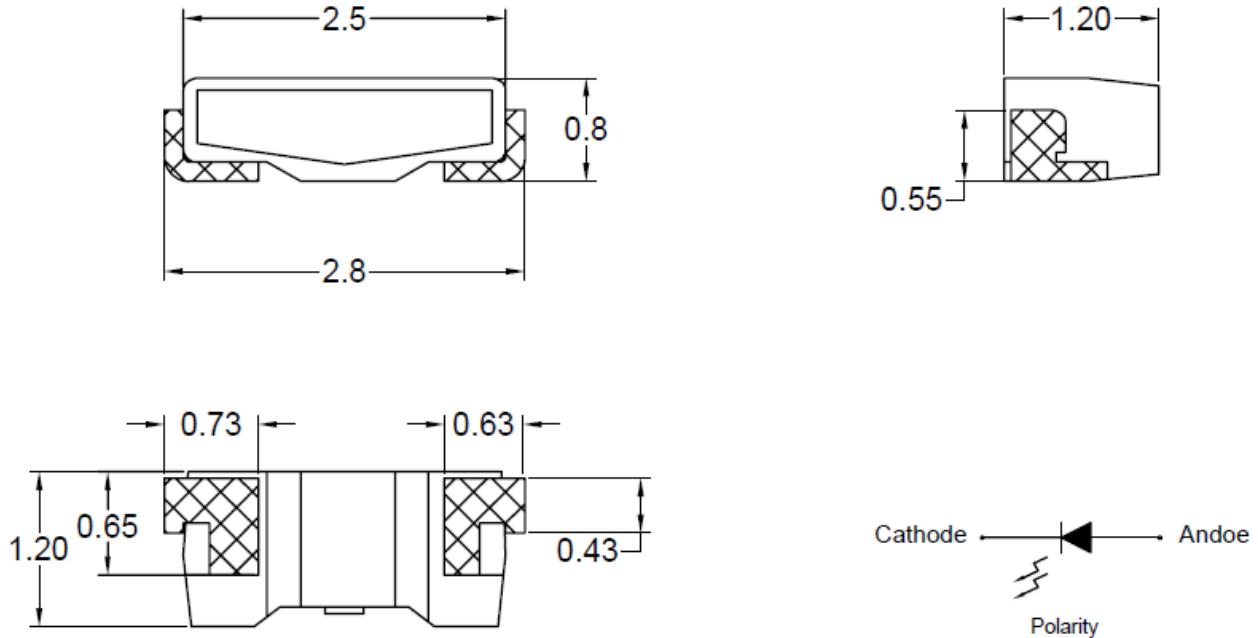

American Opto Plus LED Corp. L233QBC-TR

2.8 x 0.8 x 1.2 Right Angle BLUE SMD, Tape and Reel

PACKAGE OUTLINES



RECOMMENDED SOLDERING PAD DIMENSIONS

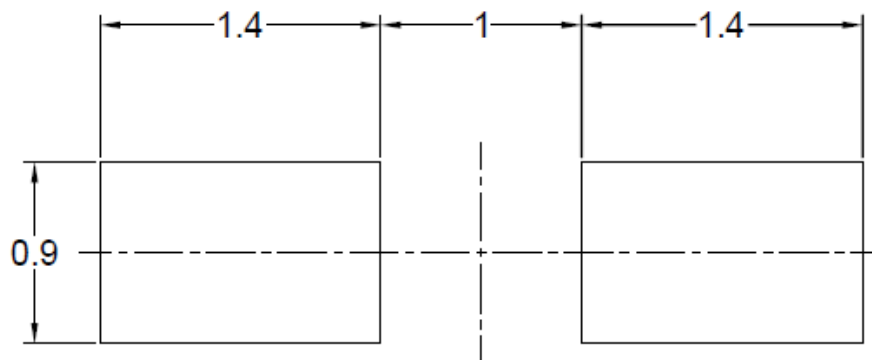

Part Number	Material	Lens Color	
		Emitted	Lens
L233QBC-TR	InGaN	Blue	Water Clear

Notes:

1. All dimension is in millimeter;
2. Tolerance ± 0.1 mm unless, angle ± 0.5 mm unless otherwise noted



American Opto Plus LED Corp.

L233QBC-TR

2.8 x 0.8 x 1.2 Right Angle BLUE SMD, Tape and Reel

ABSOLUTE MAXIMUM RATINGS

(Ta=25°C)

Parameter	Symbol	Value	Unit
Forward Current	I_F	30	mA
Peak Forward Current (Duty 1/11 @ 10Khz)	I_{FP}	100	mA
Reverse Current @ 5V	I_R	50	μ A
Power Dissipation	P_D	108	mW
Electrostatic Discharge	ESD	500	V
Operating Temperature Range	T_{OPR}	-20~+80	°C
Storage Temperature Range	T_{STG}	-30~+100	°C

OPTICAL-ELECTRICAL CHARACTERISTICS

(Ta=25°C)

Parameter	Symbol	Test Condition	Min	Typ	Max	Unit
Luminous Intensity	I_V	$I_F = 20\text{mA}$	200	260	--	mcd
Dominant Wavelength	λ_D		465	--	477	nm
Spectral Line Half-Width	$\Delta\lambda$		--	30	--	nm
Viewing Angle	$2\theta \frac{1}{2}$		--	115	--	deg
Forward Voltage	V_F		2.8	--	3.6	V

1. Forward voltage data did not include $\pm 0.1\text{V}$ testing tolerance.
2. Luminous intensity data did not include $\pm 15\%$ testing tolerance.



American Opto Plus LED Corp.

L233QBC-TR

2.8 x 0.8 x 1.2 Right Angle BLUE SMD, Tape and Reel

LUMINOUS INTENSITY CLASSIFICATION

BIN CODE		Iv(mcd) at 20mA	
		Min.	Max.
S	S1	200	230
	S2	230	260
	S3	260	290
	S4	290	320

DOMINANT WAVELENGTH CLASSIFICATION

BIN CODE	λ_D (nm) at 20mA	
	Min.	Max.
0D	465	468
0C	468	471
0B	471	474
0A	474	477

FORWARD VOLTAGE CLASSIFICATION

BIN CODE	Vf(v) at 20mA	
	Min.	Max.
1	2.8	2.9
2	2.9	3.0
3	3.0	3.1
4	3.1	3.2
5	3.2	3.3
6	3.3	3.4
7	3.4	3.5
8	3.5	3.6



American Opto Plus LED Corp. L233QBC-TR

2.8 x 0.8 x 1.2 Right Angle BLUE SMD, Tape and Reel

TYPICAL ELECTRO-OPTICAL CHARACTERISTIC CURVES

Fig.1 Forward current vs. Forward Voltage

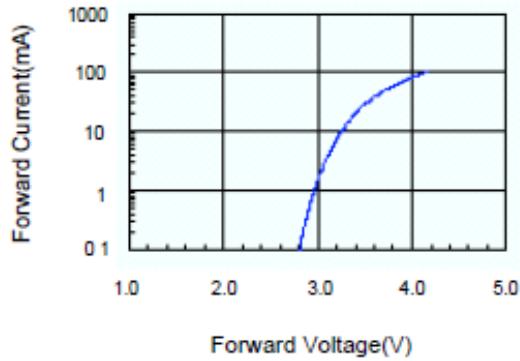

Fig.2 Relative Intensity vs. Forward Current

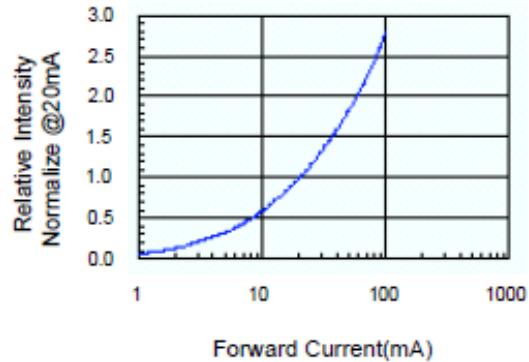

Fig.3 Forward Voltage vs. Temperature

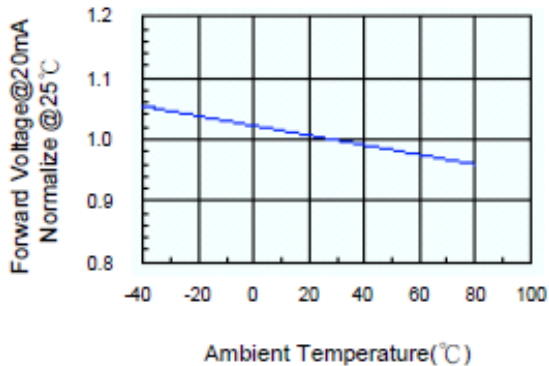

Fig.4 Relative Intensity vs. Temperature

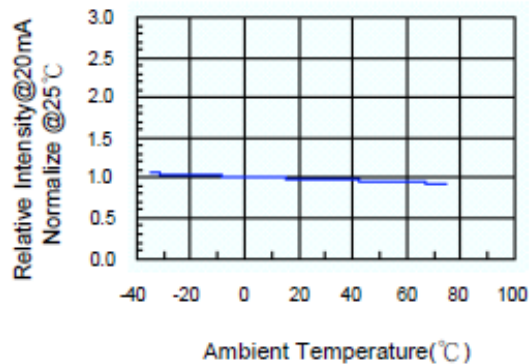

Fig.5 Relative Intensity vs. Wavelength

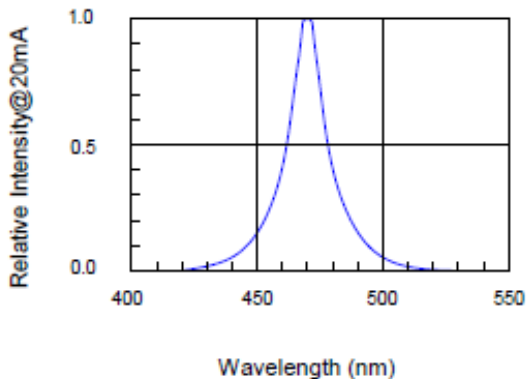
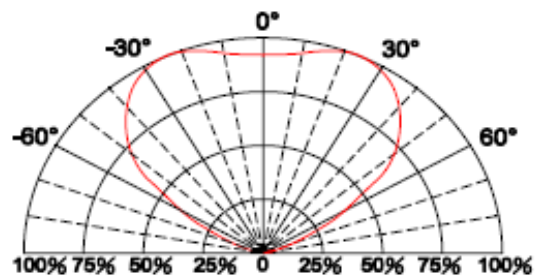

Fig.6 Directive Radiation





American Opto Plus LED Corp. L233QBC-TR

2.8 x 0.8 x 1.2 Right Angle BLUE SMD, Tape and Reel

CARRIER TAPE DIMENSION

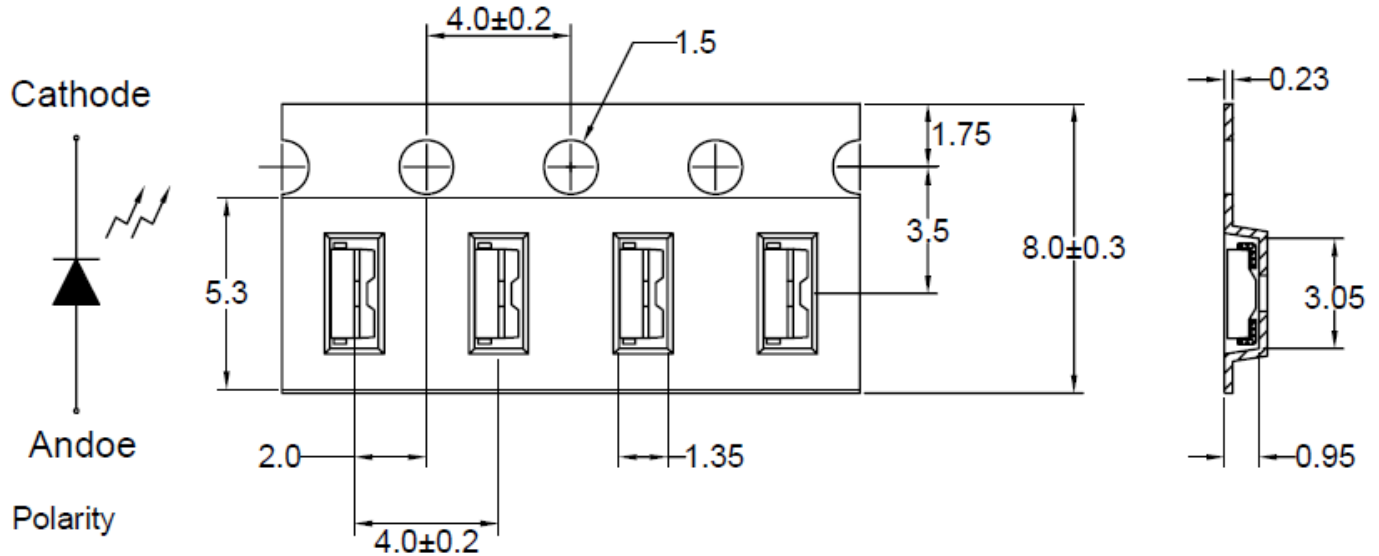

Note: The tolerances unless mentioned are ± 0.1 mm, Angle ± 0.5 mm

REEL DIMENSIONS

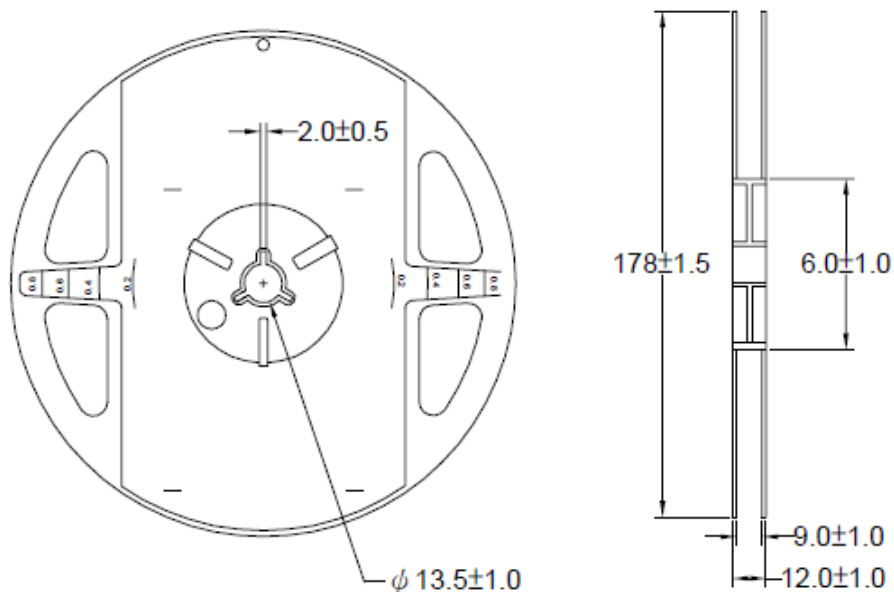

Note: 8.0mm tape, 7: reel / 3000 devices per reel.



American Opto Plus LED Corp. L233QBC-TR

2.8 x 0.8 x 1.2 Right Angle BLUE SMD, Tape and Reel

RECOMMENDED SOLDERING CONDITIONS

Soldering Iron:

Basic spec is ≤ 5 seconds when 260°C .

Power dissipation of iron should be smaller than 25W, and temperature should be controllable.

Surface temperature of the device should be under 280°C for 3 seconds.

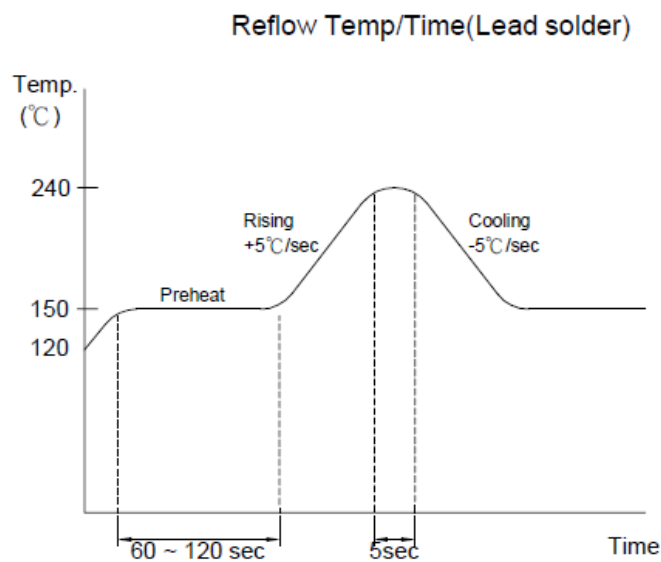
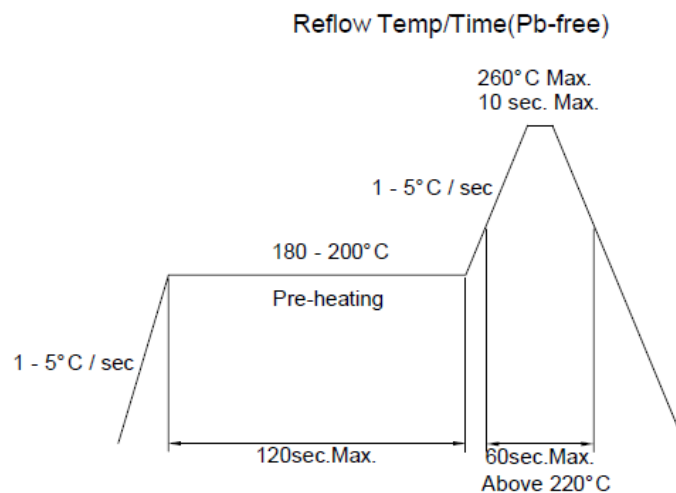

Notes:

1. Reflow soldering should not be done more than two times.
2. When soldering, do not put stress on the LEDs during heating.
3. After soldering, do not warp the circuit board.



American Opto Plus LED Corp.

L233QBC-TR

2.8 x 0.8 x 1.2 Right Angle BLUE SMD, Tape and Reel

PRECAUTIONS FOR USE

Storage Time:

1. The operation of temperatures and RH are: 5°C~35°C, RH60%.
2. Once the package is opened, the products should be used within a week. Otherwise, they should be kept in a damp proof box with desiccating agent. Considering the tape life, we suggest our customers to use our products within a year (from production date).
3. If opened more than one week in an atmosphere 5°C~35°C, RH60%, they should be treated at 60°C±5°C for 15hrs.

Drive Method:

LED is a current operated device, and therefore, require some kind of current limiting incorporated into the driver circuit. This current limiting typically takes the form of a current limiting resistor placed in a series with the LED.

Consider worst case voltage variations that could occur across the current limiting resistor. The forward current should not be allowed to change by more than 40% of its desired value.

Circuit model A

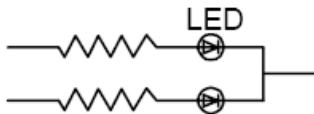

Circuit model B

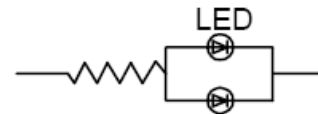

(A) Recommended circuit.

(B) The difference of brightness between LED could be found due to the VF-IF characteristics of LED.

Cleaning:

Use alcohol-based cleaning solvents such as isopropyl alcohol to clean the LED.

ESD (Electrostatic Discharge):

Static Electricity or power surge will damage the LED. Use of a conductive wrist band or anti-electrostatic glove is recommended when handling these LEDs. All devices and machinery must be properly grounded.



American Opto Plus LED Corp.

L233QBC-TR

2.8 x 0.8 x 1.2 Right Angle BLUE SMD, Tape and Reel

RELIABILITY TEST:

(1) Test items and results

Classification	Test Item	Test Conditions	Sample Size
Endurance Test	Operating Life Test	1. Ta=under room temperature as per data sheet maximum rating 2. If=20mA 3. t=1000 hrs	22
	High Temperature Storage Test	1. Ta=105°C±5°C 2. t=500 hrs	22
	Low Temperature Storage Test	1. Ta=40°C±5°C 2. t=1000 hrs	22
	High Temperature High Humidity Storage Test	1. IR-Reflow in-board, 2 times 2. Ta=85°C±5°C 3. RH=90%~95% 4. t=500hrs±2hrs	22
Environmental Test	Thermal Shock Test	1. IR-Reflow in-board, 2 times 2. Ta=105°C±5°C & -40°C±5°C (30min) (30min) 3. Total 100 cycles	22
	Reflow Soldering Test	1. Tsol=260°C±5°C 2. Dwell time = 10 max	22
	Temperature Cycling	1. 105°C ~ 25°C ~ -40°C 30 mins 15 mins 30 mins 2. 100 cycles	22

(2) Criteria for judging the damage

Item	Symbol	Test Conditions	Criteria for Judgement	
			Min.	Max.
Forward Voltage	V_f	$I_f=20mA$	--	U.S.L. x 1.2
Reverse Current	I_r	$V_r=5V$	--	U.S.L. x 2.0
Luminous Intensity	I_v	$I_f=20mA$	L.S.L. x 0.5	--

Note:

1. U.S.L.: Upper Standard Level. 2. L.S.L: Lower Standard Level