

Four Channel Load-Switch / LDO Configurable PMIC

FAN53840, FAN53841

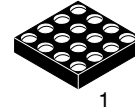

WLCSP16 1.52x1.52x0.432
CASE 567ZM

General Description

The FAN53840 family are low Iq PMICs intended for mobile power application camera modules. The PMIC contains a high-power regulated channel for digital rails which can operate with an input as low as 1.0 V. Three channels are designed for ultra-low noise and high PSRR for sensitive analog/RF circuit loads. Each channel can be configured to operate as a pass-through load-switch, which reduces the input to output voltage drop and operating currents in critical low power applications.

The device is available in 16-bump, 0.35 mm pitch, Wafer-Level Chip-Scale Package (WLCSP).

Features

- LDO1:
 - ◆ 1.2 A Output Current Capability
 - ◆ Programmable Output Voltage 0.8 V to 1.504 V in 8 mV Steps
 - ◆ 1.0 V to 2.0 V Input Voltage Range
 - ◆ 1.1% to -1.5% Accuracy
- LDO2, LDO3, and LDO4:
 - ◆ 300 mA Output Current Capability
 - ◆ Programmable Output Voltage 1.5 V to 3.412 V in 8 mV Steps
 - ◆ 1.9 V to 5.5 V Input Voltage Range
 - ◆ Less than 20 μ V (typ) Noise
- Load-Switch Operation:
 - ◆ 100/200 m Ω Maximum Channel Resistance
 - ◆ Low Operating Currents
 - ◆ Input Voltages Down to 1.0 V and 1.8 V
- Operation Guaranteed with System Voltage Down to 2.6 V
- Soft-Start Function (SS) to Limit Inrush Current
- Current Limit to Protect Against Short Circuit
- I²C Protection Fault (UVLO and OCP in LDO Operation) Registers
- I²C Serial Control to Program Output Voltage and Features
- System UVLO and Thermal Global Shutdown Protection for LDOs
- Pb-Free Devices

Applications

- Smart Phones
- Wearables
- Smart Watch
- Health Monitoring
- Sensor Drive
- Energy Harvesting
- Utility and Safety Modules
- RF Modules

MARKING DIAGRAM

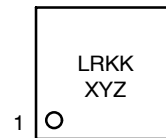

- LR = Specific Device Code
- KK = Lot Run Code
- X = Alphabetical Year Code
- Y = 2-weeks Date Code
- Z = Assembly Plant Code

ORDERING INFORMATION

See detailed ordering and shipping information on page 2 of this data sheet.

FAN53840, FAN53841

ORDERING INFORMATION

Part Number	Marking	I/O Logic Level (Note 1)	I ² C Address (Note 2)	LDO1 VOUT	LDO2 VOUT	LDO3 VOUT	LDO4 VOUT	Interrupt Pin Polarity	Temperature Range	Package	Shipping [†]
FAN53840UC00X	LR	1.8 V	7'h20	1.2 V	2.85 V	1.8 V	1.8 V	Active Low	-40°C to +85°C	20-Bump WLCSP (Pb-Free)	3000 / Tape & Reel
FAN53841UC00X	L9	1.2 V									

[†]For information on tape and reel specifications, including part orientation and tape sizes, please refer to our Tape and Reel Packaging Specifications Brochure, [BRD8011/D](#).

1. RESET_B, SDA, SCL (open drain type pins)
2. I2C address is configurable. See I2C section for more information on setting the device address

APPLICATION CIRCUIT

Application Circuit Diagram

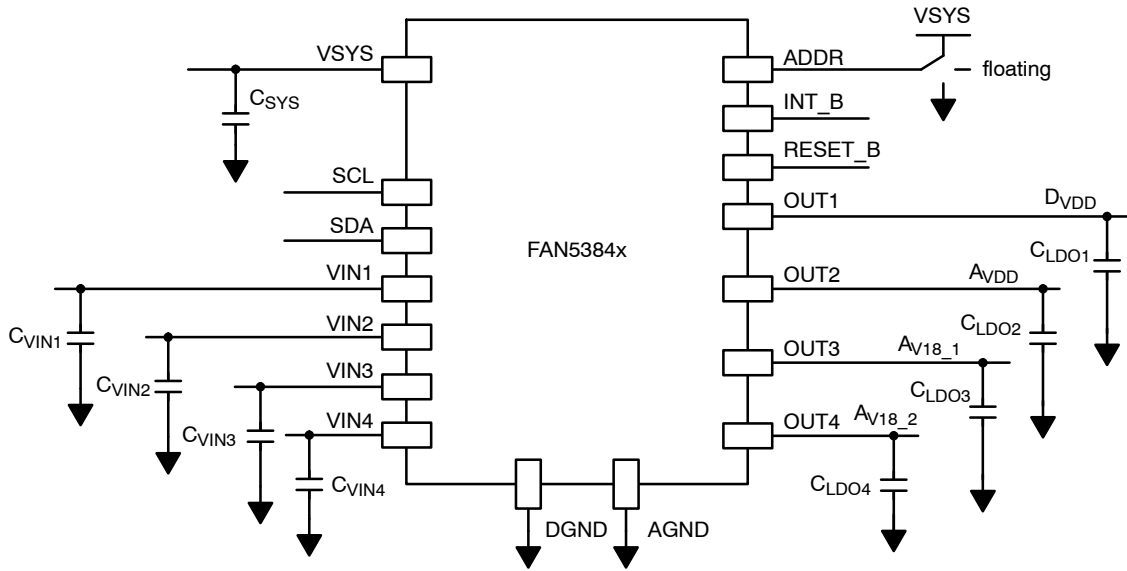

Figure 1. LDO Mode

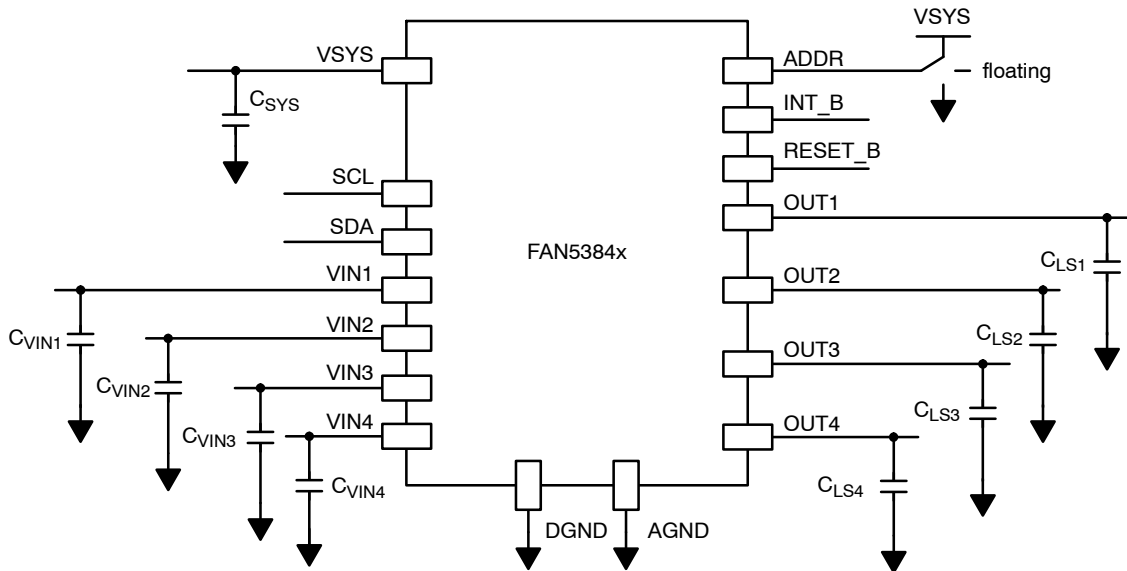

Figure 2. Load Switch Mode

FAN53840, FAN53841

Application Circuit Components

Table 1. RECOMMENDED EXTERNAL COMPONENTS

Component	Manufacturer	Part Number	Value	Case Size	Voltage Rating
C_{VIN1} , C_{VIN2} , C_{VIN3} , C_{VIN4}	Murata	GRM033R61A105ME15	1.0 μ F	0201/0603 (0.6 mm x 0.3 mm)	10 V
C_{VSYs}	Murata	GRM033R61A105ME15	1.0 μ F	0201/0503 (0.5 mm x 0.3 mm)	10 V
C_{LDO1}	Taiyo Yuden	JMK105CBJ106MV-F	10 μ F	0402/1005 (1.0 mm x 0.5 mm)	6.3 V
C_{LDO2} , C_{LDO3} , C_{LDO4}	Murata	GRM033R60J225ME47D	2.2 μ F	0201/0603 (0.6 mm x 0.3 mm)	6.3 V
C_{LS1} , C_{LS2} , C_{LS3} , C_{LS4}	Murata	GRM033R60J104KE19	0.1 μ F	0201/0603 (0.6 mm x 0.3 mm)	6.3 V

PRODUCT PIN ASSIGNMENTS

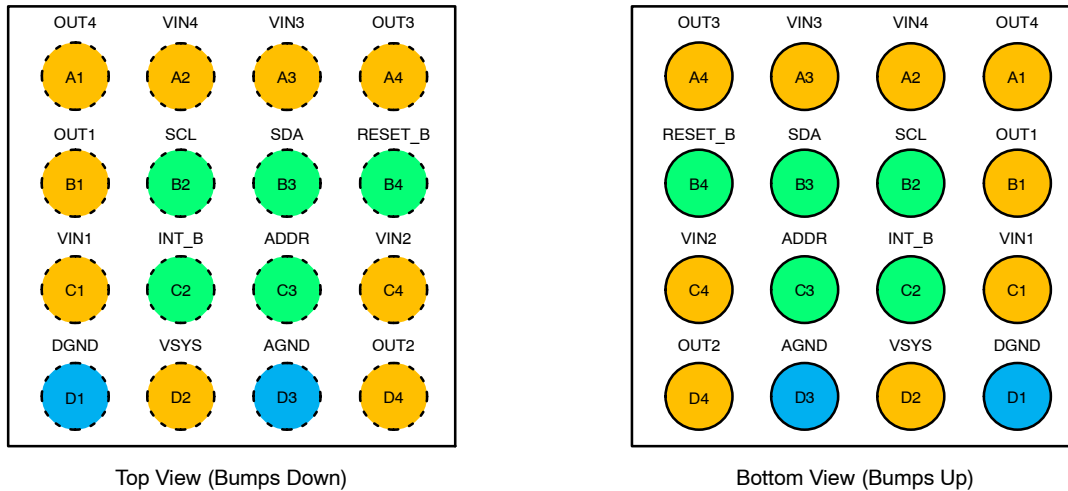

Figure 3. Pin Configuration

PIN DEFINITIONS

Pin	Pin Name	Description
A1	OUT4	This is the output pin for Channel 4. Place C_{LDO4} (or C_{LS4}) as close to this pin as possible.
A2	VIN4	Input power pin for Channel 4. Place C_{VIN4} as close to this pin as possible. If Channel 4 is unused, it is recommended to tie to VSYs.
A3	VIN3	This is the input power pin for Channel 3. Place C_{VIN3} as close to this pin as possible. If Channel 3 is unused, it is recommended to tie to VSYs.
A4	OUT3	This is the output pin for Channel 3. Place C_{LDO3} (or C_{LS3}) as close to this pin as possible.
B1	OUT1	This is the output pin for Channel 1. Place C_{LDO1} (or C_{LS1}) as close to this pin as possible.
B2	SCL	I ² C Clock pin. Node should be tied high through a pull-up resistor.
B3	SDA	I ² C Data pin. Node should be tied high through a pull-up resistor.
B4	RESET_B	RESET_B pin is used to enable basic circuits necessary for controlling the PMIC. The RESET_B pin has an internal 4 M Ω (typ) pull-down and should always be connected to a logic high or low.
C1	VIN1	Input power pin for Channel 1. Place C_{VIN1} as close to this pin as possible. If Channel 1 is unused, it is recommended to tie to VSYs.
C2	INT_B	Fault interrupt pin is an open-drain configuration and pulls low to indicate an interrupt event has occurred. This pin returns to Hi-Z when all I ² C interrupt bits equal 0. An external pull-up resistor is required.
C3	ADDR	I ² C address select pin. Either tie to ground, VSYs, or leave unconnected for desired I ² C address.
C4	VIN2	Input power pin for Channel 2. Place C_{VIN2} as close to this pin as possible. If Channel 2 is unused, it is recommended to tie to VSYs.
D1	DGND	Digital/Analog ground connection. If used as separate return for Channel 1 load, connect the return plane to AGND at a via on a plane below the AGND plane.
D2	VSYs	System power pin. Route trace from system to this pin. Connect the C_{VSYs} capacitor as close as possible to the pin.
D3	AGND	Digital/Analog ground connection. Tie to power plane.
D4	OUT2	This is the output pin for Channel 2. Place C_{LDO2} (or C_{LS2}) as close to this pin as possible.

FAN53840, FAN53841

PRODUCT BLOCK DIAGRAM

Block Diagram

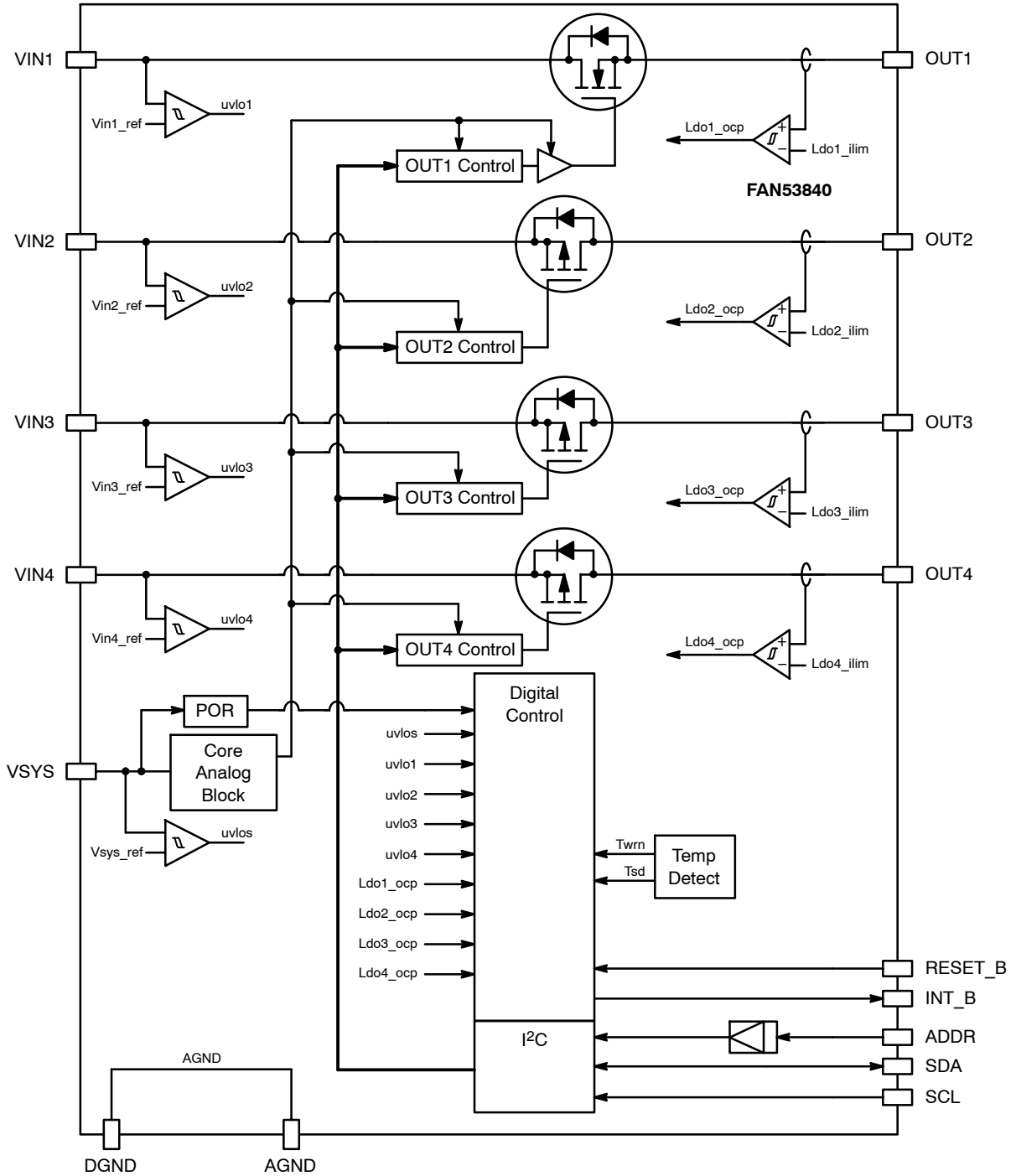

Figure 4. Block Diagram

FAN53840, FAN53841

MAXIMUM RATINGS

Symbol	Parameter	Conditions	Min	Typ	Max	Unit
V _{SYS}	System Supply Voltage Range		-0.3	-	6.0	V
V _{IN1}	Low-Voltage Supply Range		-0.3	-	6.0	V
V _{IN2} , V _{IN3} , V _{IN4}	High-Voltage Supply Range		-0.3	-	6.0	V
V _{CTRL}	SDA, SCL, and RESET_B		-0.3	-	6.0	V
V _{INTB}	INT_B		-0.3	-	6.0	V
V _{OUT1/2/3/4}	All Supply Output Pins		-0.3	-	V _{IN1/2/3/4} + 0.3 V	V
I _{pin_max}	Pin Current		-	-	1.5	A
ESD	ESD – HBM	Human Body Model	-	2.0	-	kV
ESD	ESD – CDM	Charged Device Model	-	500	-	V
T _J	Junction Temperature		-40	-	+150	°C
T _{STG}	Storage Temperature		-65	-	+150	°C
T _L	Soldering Temperature		-	-	+260	°C

Stresses exceeding those listed in the Maximum Ratings table may damage the device. If any of these limits are exceeded, device functionality should not be assumed, damage may occur and reliability may be affected.

THERMAL CHARACTERISTICS

Symbol	Characteristic	Conditions	Min	Typ	Max	Unit
θ _{JA}	Thermal Resistance Junction/Air	1S PCB @ 0.5 W Dissipation	-	126	-	°C/W
θ _{JB}	Thermal Resistance Junction/Board	2S2P w/ Vias @0.5 W Dissipation	-	45	-	°C/W

RECOMMENDED OPERATING CONDITIONS

Symbol	Parameter	Conditions	Min	Typ	Max	Unit
V _{SYS}	Supply Voltage Range – CHAN1	V _{SYS} relative to OUT1	V _{OUT1} + 1.95 V	-	5.5	V
V _{SYS}	Supply Voltage Range – CHAN2/3/4	V _{SYS} relative to OUT2/3/4	2.6	-	5.5	V
V _{IN1}	CHAN1 Input Supply Voltage Range	LDO and LS Modes	1.0	-	2.0	V
V _{IN1}	CHAN1 LDO Mode Headroom	V _{IN1} – V _{OUT1}	200	-		mV
V _{IN2/3/4}	CHAN2/3/4 LDO Mode Supply Voltage Range		1.9	-	5.5	V
V _{IN2/3/4}	CHAN2/3/4 LDO Mode Headroom	V _{IN2} – V _{OUT2} , V _{IN3} – V _{OUT3} , and V _{IN4} – V _{OUT4}	300	-	-	mV
V _{IN2/3/4}	CHAN2/3/4 LS Mode Supply Voltage Range (Note 3)	Any Channel in LDO Mode	1.8	-	5.0	V
		CHAN1/2/3/4 = LS Mode	1.7	-	5.0	V
P _D	Max Power Dissipation	P _D = (125°C – 85°C) / 45°C/W = 0.88 W	-	-	0.88	W
T _A	Ambient Temperature		-40	-	+85	°C
T _J	Junction Temperature		-40	-	+125	°C

Functional operation above the stresses listed in the Recommended Operating Ranges is not implied. Extended exposure to stresses beyond the Recommended Operating Ranges limits may affect device reliability.

3. Please refer to the Under Voltage Lockout (UVLO) section in Device Operation for details.

FAN53840, FAN53841

ELECTRICAL CHARACTERISTICS

Unless otherwise noted, the device is characterized for minimums and maximums across the ranges listed in the Recommended Operating Conditions. All limits are characterized using components from Recommended External Components table.

Production testing and testing for typical values is performed at $T_A = 25^\circ\text{C}$, For LDO Mode: $V_{\text{SYS}} = 3.45\text{ V}$, $V_{\text{VIN1}} = 1.3\text{ V}$, $V_{\text{VIN2}} = 3.45\text{ V}$, V_{VIN3} and $V_{\text{VIN4}} = 1.95\text{ V}$; For LS Mode: $V_{\text{SYS}} = 3.80\text{ V}$, $V_{\text{VIN1}} = V_{\text{VIN3}} = V_{\text{VIN4}} = 1.8\text{ V}$ and $V_{\text{VIN2}} = 5.0\text{ V}$.

Symbol	Parameter	Conditions	Min	Typ	Max	Unit
--------	-----------	------------	-----	-----	-----	------

POWER SUPPLY UVLO

$V_{\text{SYS UVLO_RS}}$	System Under-Voltage Lockout Threshold	Rising V_{SYS}	2.30	2.35	2.40	V
$V_{\text{SYS UVLO_FL}}$	System Under-Voltage Lockout Threshold	Falling V_{SYS}	2.20	2.25	2.30	V
$V_{\text{VIN1 UVLO_RS}}$	Channel 1 Under-Voltage Lockout Threshold	Rising V_{VIN1}	0.90	0.95	1.00	V
$V_{\text{VIN1 UVLO_FL}}$	Channel 1 Under-Voltage Lockout Threshold	Falling V_{VIN1}	0.80	0.85	0.92	V
$V_{\text{VIN_H UVLO_RS}}$	Channel 2/3/4 Under-Voltage Lockout Threshold	Rising $V_{\text{VIN2/3/4}}$	1.80	1.85	1.90	V
$V_{\text{VIN_H UVLO_FL}}$	Channel 2/3/4 Under-Voltage Lockout Threshold	Falling $V_{\text{VIN2/3/4}}$	1.70	1.75	1.80	V

CHANNEL 1 QUIESCENT CURRENT

I_{QLD1}	Quiescent Current, LDO Mode	$I_{\text{OUT1}} = 0\text{ A}$, total $I_{\text{V_SYS}}$ and $I_{\text{V_IN1}}$ currents when $\text{LDO_LS1_SELECT} = 0$, $\text{CHAN1_EN} = 1$ and all other channels disabled.	–	67	75	μA
I_{QLS1}	Quiescent Current, LS Mode	$I_{\text{OUT1}} = 0\text{ A}$, total $I_{\text{V_SYS}}$ and $I_{\text{V_IN1}}$ currents when all $\text{LDO_LSx_SELECT} = 1$, $\text{CHAN1_EN} = 1$ and all other channels are disabled.	–	1.29	3.0	μA

CHANNEL 1 OUTPUT VOLTAGE

VOL1_ACC	LDO1 Output Voltage Accuracy	$I_{\text{OUT1}} = 1\text{ mA}$ and 1200 mA , $V_{\text{VIN1}} = 2.0\text{ V}$, $V_{\text{SYS}} = 3.45\text{ V}$, $V_{\text{OUT1}} = 0.8$ to 1.5 V	–1.5	–	+1.1	%
$V_{\text{L1_DO_600}}$	LDO1 Dropout Voltage (Note 4)	$I_{\text{OUT1}} = 600\text{ mA}$, $V_{\text{OUT1}} = 1.20\text{ V}$, and $V_{\text{SYS}} = 3.00\text{ V}$	–	50	85	mV
$V_{\text{L1_DO_1000}}$	LDO1 Dropout Voltage (Note 4)	$I_{\text{OUT1}} = 1000\text{ mA}$, $V_{\text{OUT1}} = 1.05\text{ V}$, and $V_{\text{SYS}} = 3.00\text{ V}$	–	77	125	mV

CHANNEL 1 DRAIN-SOURCE ON RESISTANCE

$R_{\text{DS(on)1}}$	LS1 $R_{\text{DS(on)}}$	$V_{\text{VIN1}} = 1.8\text{ V}$, $V_{\text{SYS}} = 3.2\text{ V}$, all $\text{LDO_LSx_SELECT} = 1$, $\text{CHAN1_EN} = 1$, and $I_{\text{OUT1}} = 50\text{ mA}$	–	76	175	$\text{m}\Omega$
----------------------	-------------------------	--	---	----	-----	------------------

CHANNEL 1 CURRENT LIMIT

$I_{\text{LIM_H1}}$	Current Limit	$V_{\text{VIN1}} \geq V_{\text{OUT1}} + 300\text{ mV}$ and $V_{\text{VIN1}} = 1.1$ to 2.0 V , $V_{\text{SYS}} \geq V_{\text{OUT1}} + 1.95\text{ V}$	1250	1400	1700	mA
$T_{\text{L1 OC_RST}}$	Over-Current Restart Timer		–	20	–	ms
$T_{\text{L1 OC_DEB}}$	Over-Current Debounce Timer	$I^2\text{C Register } 0x07\text{h} = 11$	–	1.0	–	ms

CHANNEL 1 OUTPUT PROTECTION

$R_{\text{L1_DCHG}}$	Output Discharge		80	100	120	Ω
-----------------------	------------------	--	----	-----	-----	----------

FAN53840, FAN53841

ELECTRICAL CHARACTERISTICS (continued)

Unless otherwise noted, the device is characterized for minimums and maximums across the ranges listed in the Recommended Operating Conditions. All limits are characterized using components from Recommended External Components table.

Production testing and testing for typical values is performed at $T_A = 25^\circ\text{C}$, For LDO Mode: $V_{V_{SYS}} = 3.45\text{ V}$, $V_{V_{IN1}} = 1.3\text{ V}$, $V_{V_{IN2}} = 3.45\text{ V}$, $V_{V_{IN3}}$ and $V_{V_{IN4}} = 1.95\text{ V}$; For LS Mode: $V_{V_{SYS}} = 3.80\text{ V}$, $V_{V_{IN1}} = V_{V_{IN3}} = V_{V_{IN4}} = 1.8\text{ V}$ and $V_{V_{IN2}} = 5.0\text{ V}$.

Symbol	Parameter	Conditions	Min	Typ	Max	Unit
--------	-----------	------------	-----	-----	-----	------

CHANNEL 2 QUIESCENT CURRENT

$I_{Q_{LD2}}$	Quiescent Current, LDO Mode	$I_{OUT2} = 0\text{ A}$, total $I_{V_{SYS}}$ and $I_{V_{IN2}}$ currents when LDO_LS2_SELECT = 0, CHAN2_EN = 1 and all other channels disabled.	–	55	63	μA
$I_{Q_{LS2}}$	Quiescent Current, LS Mode	$I_{OUT2} = 0\text{ A}$, total $I_{V_{SYS}}$ and $I_{V_{IN2}}$ currents when all LDO_LSx_SELECT = 1, CHAN2_EN = 1 and all other channels are disabled.	–	1.32	3.5	μA

CHANNEL 2 OUTPUT VOLTAGE

VO_{L2_ACC}	LDO2 Output Voltage Accuracy	$I_{OUT} = 1\text{ mA}$ and 300 mA, $V_{SYS} = 3.45\text{ V}$, $V_{IN2} \geq 3.45\text{ V}$ and $V_{IN2} \geq V_{OUT} + 300\text{ mV}$, $V_{OUT} = 1.5\text{ to }3.412\text{ V}$	-1.3	–	+1.0	%
V_{L2_DO}	LDO2 Dropout Voltage (Note 4)	$V_{OUT2} = 1.8\text{ V}$, $V_{V_{SYS}} = 3.45\text{ V}$, $I_{OUT2} = 300\text{ mA}$	–	66	100	mV

CHANNEL 2 DRAIN-SOURCE ON RESISTANCE

$R_{DS_{ON2}}$	LS2 $R_{DS(on)}$	$V_{V_{IN2}} = 5\text{ V}$, $V_{V_{SYS}} = 3.2\text{ V}$, all LDO_LSx_SELECT = 1, CHAN2_EN = 1, $I_{OUT2} = 50\text{ mA}$	–	76	100	$\text{m}\Omega$
----------------	------------------	---	---	----	-----	------------------

CHANNEL 2 CURRENT LIMIT

I_{LIM_L2}	Current Limit	$V_{V_{IN2}} \geq V_{OUT2} + 500\text{ mV}$ and $V_{V_{IN2}} = 2.0\text{ to }5.5\text{ V}$, $V_{V_{SYS}} = 3.45\text{ V}$	320	400	480	mA
$T_{L2_OC_RST}$	Over-Current Restart Timer		–	20	–	ms
$T_{L2_OC_DEB}$	Over-Current Debounce Timer	I ² C Register 0x07h = 11	–	1.0	–	ms

CHANNEL 2 OUTPUT PROTECTION

R_{L2_DCHG}	Output Discharge		80	100	120	Ω
----------------	------------------	--	----	-----	-----	----------

CHANNEL 3/4 QUIESCENT CURRENT

$I_{Q_{LD3/4}}$	Quiescent Current, LDO Mode	$I_{OUT3} = 0\text{ A}$, total $I_{V_{SYS}}$ and $I_{V_{IN3}}$ currents when LDO_LS3/4_SELECT = 0, CHAN3/4_EN = 1 and all other channels disabled.	–	55	63	μA
$I_{Q_{LS3/4}}$	Quiescent Current, LS Mode	$I_{OUT3} = 0\text{ A}$, total $I_{V_{SYS}}$ and $I_{V_{IN3}}$ currents when all LDO_LSx_SELECT = 1, CHAN3/4_EN = 1 and all other channels are disabled.	–	2.62	8	μA

CHANNEL 3/4 OUTPUT VOLTAGE

$VO_{L3/4_ACC}$	LDO3/4 Output Voltage Accuracy	$I_{OUT3/4} = 1\text{ mA}$ and 300 mA, $V_{V_{SYS}} = 3.45\text{ V}$, $V_{V_{IN3/4}} \geq 3.45\text{ V}$ and $\geq V_{OUT3/4} + 300\text{ mV}$, $V_{OUT3/4} = 1.5\text{ to }3.412\text{ V}$	-1.0	–	+1.0	%
$V_{L3/4_DO}$	LDO3/4 Dropout Voltage (Note 4)	$V_{OUT3/4} = 1.8\text{ V}$, $V_{V_{SYS}} = 3.45\text{ V}$, $I_{OUT3/4} = 300\text{ mA}$	–	68	100	mV

FAN53840, FAN53841

ELECTRICAL CHARACTERISTICS (continued)

Unless otherwise noted, the device is characterized for minimums and maximums across the ranges listed in the Recommended Operating Conditions. All limits are characterized using components from Recommended External Components table.

Production testing and testing for typical values is performed at $T_A = 25^\circ\text{C}$. For LDO Mode: $V_{\text{VSSYS}} = 3.45\text{ V}$, $V_{\text{VIN1}} = 1.3\text{ V}$, $V_{\text{VIN2}} = 3.45\text{ V}$, V_{VIN3} and $V_{\text{VIN4}} = 1.95\text{ V}$; For LS Mode: $V_{\text{VSSYS}} = 3.80\text{ V}$, $V_{\text{VIN1}} = V_{\text{VIN3}} = V_{\text{VIN4}} = 1.8\text{ V}$ and $V_{\text{VIN2}} = 5.0\text{ V}$.

Symbol	Parameter	Conditions	Min	Typ	Max	Unit
CHANNEL 3/4 DRAIN-SOURCE ON RESISTANCE						
$R_{\text{DS(on)3/4}}$	LS3/4 $R_{\text{DS(on)}}$	$V_{\text{VIN3/4}} = 1.8\text{ V}$, $V_{\text{VSSYS}} = 3.2\text{ V}$, all LDO $\text{LSx_SELECT} = 1$, $\text{CHAN3/4_EN} = 1$, $I_{\text{OUT3/4}} = 50\text{ mA}$	–	76	100	m Ω

CHANNEL 3/4 CURRENT LIMIT

$I_{\text{LIM_L3/4}}$	Current Limit	$V_{\text{VIN3/4}} \geq V_{\text{OUT3/4}} + 500\text{ mV}$ and $V_{\text{VIN3/4}} = 2.0\text{ to }5.5\text{ V}$, $V_{\text{VSSYS}} = 3.45\text{ V}$	320	400	480	mA
$T_{\text{L3/4_OC_RST}}$	Over-Current Restart Timer		–	20	–	ms
$T_{\text{L3/4_OC_DEB}}$	Over-Current Debounce Timer	$I^2\text{C Register } 0x07\text{h} = 11$	–	1.0	–	ms

CHANNEL 3/4 OUTPUT PROTECTION

$R_{\text{L3/4_DCHG}}$	Output Discharge		80	100	120	Ω
-------------------------	------------------	--	----	-----	-----	----------

I/O LEVELS

V_{IL}	RESET_B Logic Low Threshold	FAN53840			0.4	V
		FAN53841			0.325	
V_{IH}	RESET_B Logic High Threshold	FAN53840	1.2		V_{IN}	
		FAN53841	0.825		V_{IN}	
$V_{\text{OL_INT_B}}$	INT_B V_{OLmax}	$I_{\text{sink}} = 3\text{ mA}$	–	–	0.3	V
$I_{\text{INT_B}}$	INT_B Leakage	$V_{\text{INT_B}} = 5.5\text{ V}$	–	–	0.5	μA
R_{ADDR}	ADDR Input Resistance	$V_{\text{VSSYS}} = 2.6\text{ to }5.5\text{ V}$	–	893	–	k Ω
I_{ADDR}	ADDR Current	$V_{\text{VSSYS}} = 2.6\text{ to }5.5\text{ V}$	–	1.57	–	μA
ADDR $_{\text{VIH}}$	ADDR High		–	80	93	% V_{VSSYS}
ADDR $_{\text{VIL}}$	ADDR Low		8.0	20	–	% V_{VSSYS}

IQ CONDITIONS

$I_{\text{Q_VSSYS_SD}}$	System Shutdown Current	I_{VSSYS} when $V_{\text{VSSYS}} = 5.5\text{ V}$, all CHANx_EN bits = 0, $\text{RESET_B} = \text{SDA} = \text{SCL} =$ Low, and $T_J = 85^\circ\text{C}$	–	–	3.0	μA
$I_{\text{Q_VIN1_SD}}$	Channel 1 Shutdown Current	I_{VIN1} when $V_{\text{VIN1}} = 2.0\text{ V}$, all CHANx_EN bits = 0, $\text{RESET_B} = \text{SDA} = \text{SCL} =$ Low, $T_J = 85^\circ\text{C}$	–	–	0.3	μA
$I_{\text{Q_VIN2/3/4_SD}}$	Channel 2/3/4 Shutdown Current	I_{VIN2} when $V_{\text{VIN2}} = 5.5\text{ V}$; or I_{VIN3} when $V_{\text{VIN3}} = 5.5\text{ V}$; or I_{VIN4} when $V_{\text{VIN4}} = 5.5\text{ V}$. All CHANx_EN bits = 0, $\text{RESET_B} = \text{SDA} = \text{SCL} =$ Low, $T_J = 85^\circ\text{C}$	–	–	2.5	μA
$I_{\text{Q_STBY_LDO}}$	LDO Mode Standby Current	All channels configured as LDO, all enabled with no load. (Note 5)	–	200	230	μA
$I_{\text{Q_STBY_LS}}$	LS Mode Standby Current	All channels configured as LS, all enabled with no load. (Note 6)	–	5	13.0	μA

FAN53840, FAN53841

ELECTRICAL CHARACTERISTICS (continued)

Unless otherwise noted, the device is characterized for minimums and maximums across the ranges listed in the Recommended Operating Conditions. All limits are characterized using components from Recommended External Components table.

Production testing and testing for typical values is performed at $T_A = 25^\circ\text{C}$, For LDO Mode: $V_{\text{SYS}} = 3.45\text{ V}$, $V_{\text{VIN1}} = 1.3\text{ V}$, $V_{\text{VIN2}} = 3.45\text{ V}$, V_{VIN3} and $V_{\text{VIN4}} = 1.95\text{ V}$; For LS Mode: $V_{\text{SYS}} = 3.80\text{ V}$, $V_{\text{VIN1}} = V_{\text{VIN3}} = V_{\text{VIN4}} = 1.8\text{ V}$ and $V_{\text{VIN2}} = 5.0\text{ V}$.

Symbol	Parameter	Conditions	Min	Typ	Max	Unit
IQ CONDITIONS						
$I_{\text{SLP_LDO}}$	LDO Mode Sleep Current	All channels configured as LDO, all disabled with no load. (Note 7)	–	9.8	20	μA
$I_{\text{SLP_LS}}$	LS Mode Sleep Current	All channels configured as LS, all disabled with no load. (Note 8)	–	1.3	5	μA

I²C TIMING AND PERFORMANCE*

V_{IL}	SDA and SCL Low Threshold	FAN53840	–0.5	–	$0.3 V_{\text{DD}}$	V
		FAN53841	–0.5	–	0.325	V
V_{IH}	SDA and SCL High Threshold	FAN53840	$0.7 V_{\text{DD}}$	–	5.5	V
		FAN53841	0.825	–	5.5	V
V_{OL}	SDA Logic Low Output	3 mA Sink	–	–	0.24	V
I_{OL}	SDA Sink Current		20	–	–	mA
f_{SCL}	SCL Clock Frequency	Fast Mode Plus	–	–	1000	kHz
t_{BUF}	Bus-Free Time Between STOP and START Conditions	Fast Mode Plus	0.5	–	–	μs
$t_{\text{HD;STA}}$	Start or Repeated Start Hold Time	Fast Mode Plus	260	–	–	ns
t_{LOW}	SCL Low Period	Fast Mode Plus	0.5	–	–	μs
t_{HIGH}	SCL High Period	Fast Mode-Plus	260	–	–	ns
$t_{\text{SU;STA}}$	Repeated Start Setup Time	Fast Mode-Plus	260	–	–	ns
$t_{\text{SU;DAT}}$	Data Setup Time	Fast Mode Plus	50	–	–	ns
$t_{\text{VD;DAT}}$	Data Valid Time	Fast Mode Plus	–	–	450	ns
$t_{\text{VD;ACK}}$	Data Valid Acknowledge Time	Fast Mode Plus	–	–	450	ns
t_{R}	SDA and SCL Rise Time	Fast Mode Plus	–	–	120	ns
t_{F}	SCL and SDA Fall Time	Fast Mode Plus	$20 \times V_{\text{DD}} / 5.5\text{ V}$	–	120	ns
$t_{\text{SU;STO}}$	Stop Condition Setup Time	Fast Mode Plus	260	–	–	ns
C_{i}	Input Capacitance		–	–	10	pF
C_{b}	Capacitive Load for SDA and SCL		–	–	550	pF
t_{SP}	Pulse width of spikes which must be suppressed by input filter	SCL, SDA only	0	–	50	ns

Product parametric performance is indicated in the Electrical Characteristics for the listed test conditions, unless otherwise noted. Product performance may not be indicated by the Electrical Characteristics if operated under different conditions.

4. LDOx Dropout Voltage is measured by lowering V_{VINx} until $V_{\text{OUTx}} = V_{\text{OUT_TARGET}} - 50\text{ mV}$.

5. Total I_{SYS} , I_{VIN1} , I_{VIN2} , I_{VIN3} , and I_{VIN4} when $\text{RESET_B} = \text{High}$, all $\text{CHANx_EN} = 1$, and all $\text{LDO_LSx_SELECT} = 0$.

6. Total I_{SYS} , I_{VIN1} , I_{VIN2} , I_{VIN3} , and I_{VIN4} when $\text{RESET_B} = \text{High}$, all $\text{CHANx_EN} = 1$, and all $\text{LDO_LSx_SELECT} = 1$.

7. Total I_{SYS} , I_{VIN1} , I_{VIN2} , I_{VIN3} , and I_{VIN4} when $\text{RESET_B} = \text{High}$, $\text{SCL} = \text{SDA} = \text{Low}$, all $\text{CHANx_EN} = 0$, and all $\text{LDO_LSx_SELECT} = 0$.

8. Total I_{SYS} , I_{VIN1} , I_{VIN2} , I_{VIN3} , and I_{VIN4} when $\text{RESET_B} = \text{High}$, $\text{SCL} = \text{SDA} = \text{Low}$, all $\text{CHANx_EN} = 0$, and all $\text{LDO_LSx_SELECT} = 1$.

Guarantee Levels:

*Guaranteed by Design Only. Not Characterized or Production Tested.

FAN53840, FAN53841

SYSTEM CHARACTERISTICS

Unless otherwise noted, the device is characterized for minimums and maximums across the ranges listed in the Recommended Operating Conditions. All limits are characterized using components from Recommended External Components table.

Production testing and testing for typical values is performed at $T_A = 25^\circ\text{C}$, For LDO Mode: $V_{\text{SYS}} = 3.45\text{ V}$, $V_{\text{IN}1} = 1.3\text{ V}$, $V_{\text{IN}2} = 3.45\text{ V}$, $V_{\text{IN}3}$ and $V_{\text{IN}4} = 1.95\text{ V}$; For LS Mode: $V_{\text{SYS}} = 3.80\text{ V}$, $V_{\text{IN}1} = V_{\text{IN}3} = V_{\text{IN}4} = 1.8\text{ V}$ and $V_{\text{IN}2} = 5.0\text{ V}$.

Symbol	Parameter	Conditions	Min	Typ	Max	Unit
--------	-----------	------------	-----	-----	-----	------

CHANNEL 1 STARTUP

$T_{\text{SS_LDO1}}$	LDO1 StartUp Time	Measured from CHAN1_EN bit = High to 90% of $V_{\text{OUT}1} = 1.20\text{ V}$ with $I_{\text{OUT}1} = 10\text{ mA}$	–	185	–	μs
$T_{\text{SS_LS1}}$	LS1 Startup Time	Measured from CHAN1_EN bit = High to 90% of $V_{\text{IN}1} = 1.8\text{ V}$ with $I_{\text{OUT}1} = 10\text{ mA}$	–	55	–	μs

CHANNEL 1 PSRR & NOISE

$\text{PSRR}_{\text{L1_VIN}}$	Power Supply Rejection Ratio on LDO1	(Note 9) Freq = 100 kHz	–	25	–	dB
$V_{\text{N_L1}}$	LDO1 Output Noise	$V_{\text{IN}1} = 1.3\text{ V}$, $V_{\text{OUT}1} = 1.2$, Freq: 10 Hz to 100 kHz, $I_{\text{OUT}1} = 100\text{ mA}$	–	23	35	μV_{rms}

CHANNEL 1 REGULATION & TRANSIENT PERFORMANCE

$\text{REG}_{\text{L1_LD}}$	LDO1 Load Regulation	$I_{\text{OUT}1} = 1\text{ mA}$ to 1000 mA, $V_{\text{SYS}} = 3.45\text{ V}$, $V_{\text{IN}1} = 1.3\text{ V}$, $V_{\text{OUT}1} = 1.05\text{ V}$, Load used for comparison = 500 mA.	–0.5	–	+0.5	%
$\text{REG}_{\text{L1_LN}}$	LDO1 Line Regulation	$V_{\text{SYS}} = 3.45$ to 4.5 V , $V_{\text{OUT}1} + 300\text{ mV} \leq V_{\text{IN}1} \leq 2.0$, $I_{\text{OUT}1} = 50\text{ mA}$	–0.05	–	+0.05	%
$V_{\text{L1_TR_LD}}$	LDO1 Load Transient	$I_{\text{OUT}1} = 1\text{ mA} \leftrightarrow 1000\text{ mA}$, 150 mA/ μs , $V_{\text{SYS}} \geq V_{\text{OUT}1} + 1.95\text{ V}$, $V_{\text{IN}1} = 1.0$ to 1.7 V and $V_{\text{IN}1} \geq V_{\text{OUT}1} + 200\text{ mV}$; $V_{\text{OUT}1} = 0.8$ to 1.5 V	–40	–	+40	mV

CHANNEL 2 STARTUP

$T_{\text{SS_LDO2}}$	LDO2 Startup Time	Measured from CHAN2_EN bit = High to 90% of $V_{\text{OUT}2} = 2.85\text{ V}$ with $I_{\text{OUT}2} = 10\text{ mA}$	–	150	–	μs
$T_{\text{SS_LS2}}$	LS2 Startup Time	Measured from CHAN2_EN bit = High to 90% of $V_{\text{IN}2} = 5.0\text{ V}$ with $I_{\text{OUT}2} = 10\text{ mA}$	–	75	–	μs

CHANNEL 2 PSRR & NOISE

$\text{PSRR}_{\text{L2_VIN}}$	Power Supply Rejection Ratio on LDO2	(Note 10). Freq = 100 kHz	–	55	–	dB
$V_{\text{N_L2}}$	LDO2 Output Noise	$V_{\text{IN}2} = 3.45\text{ V}$, $V_{\text{OUT}2} = 2.85$, Freq: 10 Hz to 100 kHz, $I_{\text{OUT}2} = 300\text{ mA}$	–	20	–	μV_{rms}

CHANNEL 2 REGULATION & TRANSIENT PERFORMANCE

$\text{REG}_{\text{L2_LD}}$	LDO2 Load Regulation	$I_{\text{OUT}2} = 100\text{ }\mu\text{A}$ to 300 mA, $V_{\text{SYS}} = V_{\text{IN}2} = 3.45\text{ V}$, $V_{\text{OUT}2} = 2.85\text{ V}$, Load used for comparison = 150 mA.	–0.1	–	+0.1	%
------------------------------	----------------------	--	------	---	------	---

FAN53840, FAN53841

SYSTEM CHARACTERISTICS (continued)

Unless otherwise noted, the device is characterized for minimums and maximums across the ranges listed in the Recommended Operating Conditions. All limits are characterized using components from Recommended External Components table.

Production testing and testing for typical values is performed at $T_A = 25^\circ\text{C}$. For LDO Mode: $V_{\text{SYS}} = 3.45\text{ V}$, $V_{\text{VIN1}} = 1.3\text{ V}$, $V_{\text{VIN2}} = 3.45\text{ V}$, V_{VIN3} and $V_{\text{VIN4}} = 1.95\text{ V}$; For LS Mode: $V_{\text{SYS}} = 3.80\text{ V}$, $V_{\text{VIN1}} = V_{\text{VIN3}} = V_{\text{VIN4}} = 1.8\text{ V}$ and $V_{\text{VIN2}} = 5.0\text{ V}$.

Symbol	Parameter	Conditions	Min	Typ	Max	Unit
--------	-----------	------------	-----	-----	-----	------

CHANNEL 2 REGULATION & TRANSIENT PERFORMANCE

REG _{L2_LN}	LDO2 Line Regulation	$V_{\text{OUT2}} = 2.85\text{ V}$, $V_{\text{SYS}} = 2.6\text{ to }5.5\text{ V}$, $V_{\text{VIN2}} = 3.15\text{ V}$ and $V_{\text{OUT2}} + 300\text{ mV} \leq V_{\text{VIN2}} \leq 5.5\text{ V}$, $V_{\text{SYS}} = 3.45\text{ V}$, $V_{\text{OUT2}} = 1.5\text{ to }3.412$, $I_{\text{OUT2}} = 50\text{ mA}$	-0.10	-	+0.10	%
V _{L2} TR_LD	LDO1 Load Transient	$I_{\text{OUT2}} = 1\text{ mA} \leftrightarrow 300\text{ mA}$, $50\text{ mA}/\mu\text{s}$, $V_{\text{SYS}} = 3.45\text{ V}$, $V_{\text{VIN2}} \geq 3.00\text{ V}$ to 5.5 V and $V_{\text{VIN2}} \geq V_{\text{OUT2}} + 300\text{ mV}$, $V_{\text{OUT2}} = 2.7\text{ to }3.4\text{ V}$	-26	-	+20	mV

CHANNEL 3 STARTUP

T _{SS_LDO3}	LDO3 Startup Time	Measured from CHAN3_EN bit = High to 90% of $V_{\text{OUT3}} = 1.8\text{ V}$ with $I_{\text{OUT3}} = 10\text{ mA}$	-	150	-	μs
T _{SS_LS3}	LS3 Startup Time	Measured from CHAN3_EN bit = High to 90% of $V_{\text{VIN3}} = 1.8\text{ V}$, $I_{\text{OUT3}} = 10\text{ mA}$	-	150	-	μs

CHANNEL 3 PSRR & NOISE

PSRR _{L3_VIN}	Power Supply Rejection Ratio on LDO3	(Note 11) Freq = 100 kHz	-	41	-	dB
V _{N_L3}	LDO3 Output Noise	Freq: 10 Hz to 100 kHz, $I_{\text{OUT}} = 300\text{ mA}$	-	20	-	μV_{rms}

CHANNEL 3 REGULATION & TRANSIENT PERFORMANCE

REG _{L3_LD}	LDO3 Load Regulation	$I_{\text{OUT3}} = 100\text{ }\mu\text{A}$ to 300 mA , $V_{\text{SYS}} = 3.45\text{ V}$, $V_{\text{VIN3}} = 1.95\text{ V}$, $V_{\text{OUT3}} = 1.8\text{ V}$, Load used for comparison = 150 mA .	-0.1	-	+0.1	%
REG _{L3_LN}	LDO3 Line Regulation	$V_{\text{OUT3}} = 1.8\text{ V}$, $V_{\text{SYS}} = 2.6\text{ to }5.5\text{ V}$, $V_{\text{VIN3}} = 2.3\text{ V}$ and $V_{\text{SYS}} = 3.45\text{ V}$, $V_{\text{VIN3}} = 2.3\text{ to }5.5\text{ V}$, $I_{\text{OUT3}} = 50\text{ mA}$	-0.10	-	+0.10	%
V _{L3} TR_LD	LDO3 Load Transient	$I_{\text{OUT3}} = 1\text{ mA} \leftrightarrow 300\text{ mA}$, $50\text{ mA}/\mu\text{s}$, $V_{\text{VIN3}} \geq 9\text{ V}$ & $V_{\text{VIN3}} \geq V_{\text{OUT3}} + 200\text{ mV}$, $V_{\text{OUT3}} = 1.5\text{ to }3.4\text{ V}$	-30	-	+15	mV

CHANNEL 4 STARTUP

T _{SS_LDO4}	LDO4 Startup Time	Measured to CHAN4_EN bit = High to 90% of $V_{\text{OUT4}} = 1.80\text{ V}$, $I_{\text{OUT4}} = 10\text{ mA}$	-	175	-	μs
T _{SS_LS4}	LS4 Startup Time	Measured to CHAN4_EN bit = High to 90% of $V_{\text{VIN4}} = 1.8\text{ V}$, $I_{\text{OUT4}} = 10\text{ mA}$	-	150	-	μs

CHANNEL 4 PSRR & NOISE

PSRR _{L4_VIN}	Power Supply Rejection Ratio on LDO4	(Note 12) Freq = 100 kHz	-	41	-	dB
------------------------	--------------------------------------	--------------------------	---	----	---	----

FAN53840, FAN53841

SYSTEM CHARACTERISTICS (continued)

Unless otherwise noted, the device is characterized for minimums and maximums across the ranges listed in the Recommended Operating Conditions. All limits are characterized using components from Recommended External Components table.

Production testing and testing for typical values is performed at $T_A = 25^\circ\text{C}$. For LDO Mode: $V_{\text{SYS}} = 3.45\text{ V}$, $V_{\text{VIN1}} = 1.3\text{ V}$, $V_{\text{VIN2}} = 3.45\text{ V}$, V_{VIN3} and $V_{\text{VIN4}} = 1.95\text{ V}$; For LS Mode: $V_{\text{SYS}} = 3.80\text{ V}$, $V_{\text{VIN1}} = V_{\text{VIN3}} = V_{\text{VIN4}} = 1.8\text{ V}$ and $V_{\text{VIN2}} = 5.0\text{ V}$.

Symbol	Parameter	Conditions	Min	Typ	Max	Unit
--------	-----------	------------	-----	-----	-----	------

CHANNEL 4 PSRR & NOISE

$V_{\text{N_L4}}$	LDO4 Output Noise	Freq: 10 Hz to 100 kHz, $I_{\text{OUT4}} = 300\text{ mA}$	–	20	–	μV_{rms}
--------------------	-------------------	--	---	----	---	----------------------------

CHANNEL 4 REGULATION & TRANSIENT PERFORMANCE

$\text{REG}_{\text{L4_LD}}$	LDO4 Load Regulation	$I_{\text{OUT4}} = 100\ \mu\text{A}$ to 300 mA , $V_{\text{VIN4}} = 1.95\text{ V}$, $V_{\text{SYS}} = 3.45\text{ V}$, $V_{\text{OUT4}} = 1.8\text{ V}$, Load used for comparison = 150 mA .	–0.1	–	+0.1	%
$\text{REG}_{\text{L4_LN}}$	LDO4 Line Regulation	$V_{\text{OUT4}} = 1.8\text{ V}$, $V_{\text{SYS}} = 2.6$ to 5.5 V , $V_{\text{VIN4}} = 2.3\text{ V}$ and $V_{\text{SYS}} = 3.45\text{ V}$, $V_{\text{VIN4}} = 2.3$ to 5.5 V , $I_{\text{OUT4}} = 50\text{ mA}$	–0.10	–	+0.10	%
$V_{\text{L4 TR_LD}}$	LDO3 Load Transient	$I_{\text{OUT4}} = 1\text{ mA} \leftrightarrow 300\text{ mA}$, $50\text{ mA}/\mu\text{s}$, $V_{\text{VIN4}} \geq 1.9\text{ V}$ & $V_{\text{VIN4}} \geq V_{\text{OUT4}} + 200\text{ mV}$, $V_{\text{OUT4}} = 1.5$ to 3.4 V	–30	–	+15	mV

THERMAL PROTECTION

T_{WRN}	Thermal Warning		115	125	135	$^\circ\text{C}$
T_{SD}	Thermal Shutdown		125	140	155	$^\circ\text{C}$
T_{HYS}	Thermal Hysteresis		15	20	25	$^\circ\text{C}$

9. $V_{\text{VIN1}} = 1.3\text{ V}$, $V_{\text{SYS}} = 3.45\text{ V}$, $V_{\text{OUT1}} = 1.2\text{ V}$, $I_{\text{OUT1}} = 150\text{ mA}$, $C_{\text{VIN1}} = 1.0\ \mu\text{F}$, $C_{\text{LDO1}} = 10\ \mu\text{F}$.
10. $V_{\text{VIN2}} = 3.45\text{ V}$, $V_{\text{SYS}} = 3.45\text{ V}$, $V_{\text{OUT2}} = 2.85\text{ V}$, $I_{\text{OUT2}} = 100\text{ mA}$, $C_{\text{VIN2}} = 1.0\ \mu\text{F}$, $C_{\text{LDO2}} = 2.2\ \mu\text{F}$.
11. $V_{\text{VIN3}} = 1.95\text{ V}$, $V_{\text{SYS}} = 3.45\text{ V}$, $V_{\text{OUT3}} = 1.8\text{ V}$, $I_{\text{OUT3}} = 100\text{ mA}$, $C_{\text{VIN3}} = 1.0\ \mu\text{F}$, $C_{\text{LDO3}} = 2.2\ \mu\text{F}$.
12. $V_{\text{VIN4}} = 1.95\text{ V}$, $V_{\text{SYS}} = 3.45\text{ V}$, $V_{\text{OUT4}} = 1.8\text{ V}$, $I_{\text{OUT4}} = 100\text{ mA}$, $C_{\text{VIN4}} = 1.0\ \mu\text{F}$, $C_{\text{LDO4}} = 2.2\ \mu\text{F}$.

TYPICAL CHARACTERISTICS

(Unless otherwise noted, $T_A = 25^\circ\text{C}$, For LDO Mode: $V_{\text{SYS}} = 3.45\text{ V}$, $V_{\text{VIN1}} = 1.3\text{ V}$, $V_{\text{VIN2}} = 3.45\text{ V}$, V_{VIN3} and $V_{\text{VIN4}} = 1.95\text{ V}$; For LS Mode: $V_{\text{SYS}} = 3.80\text{ V}$, $V_{\text{VIN1}} = V_{\text{VIN3}} = V_{\text{VIN4}} = 1.8\text{ V}$ and $V_{\text{VIN2}} = 5.0\text{ V}$. Using components from Recommended External Components.)

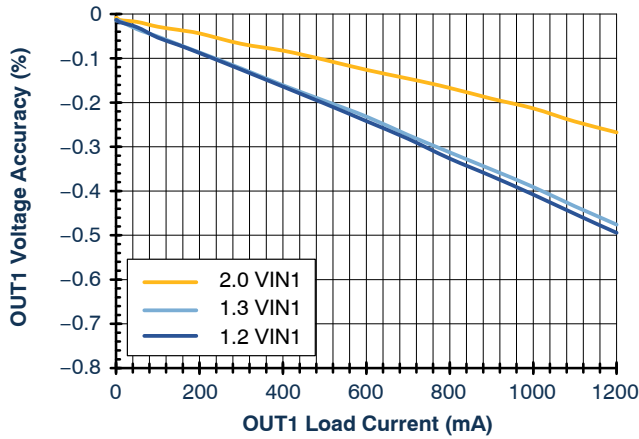

Figure 5. LDO1 Output Voltage Accuracy vs. Load Current and Input Voltage, $V_{\text{OUT1}} = 1.05\text{ V}$

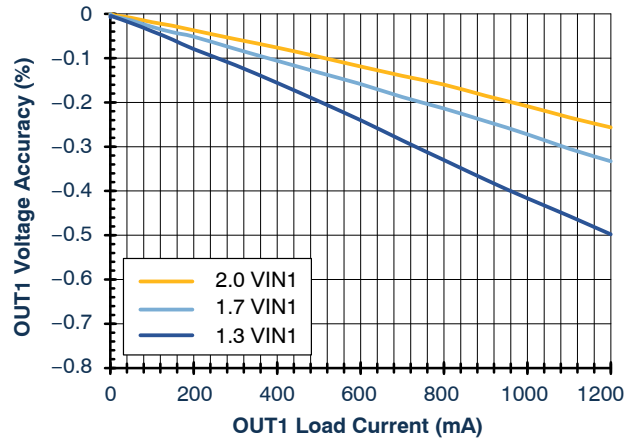

Figure 6. LDO1 Output Voltage Accuracy vs. Load Current and Input Voltage, $V_{\text{OUT1}} = 1.2\text{ V}$

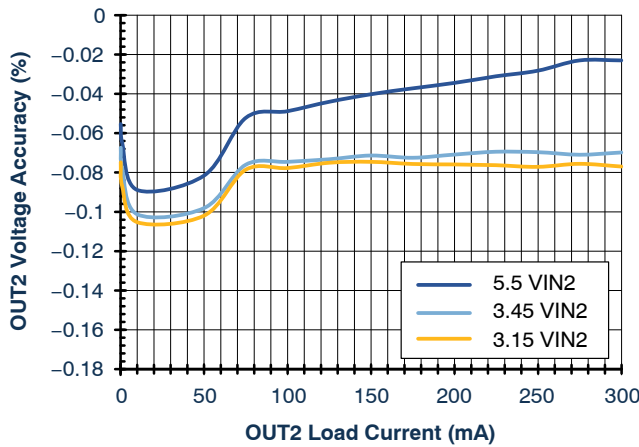

Figure 7. LDO2 Output Voltage Accuracy vs. Load Current and Input Voltage, $V_{\text{OUT2}} = 2.85\text{ V}$

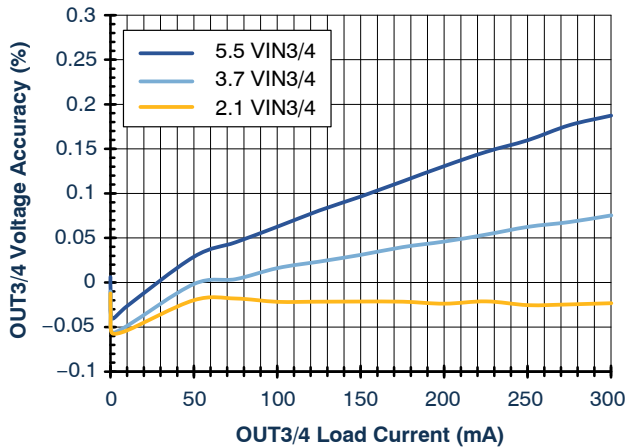

Figure 8. LDO3/4 Output Voltage Accuracy vs. Load Current and Input Voltage, $V_{\text{OUT3/4}} = 1.8\text{ V}$

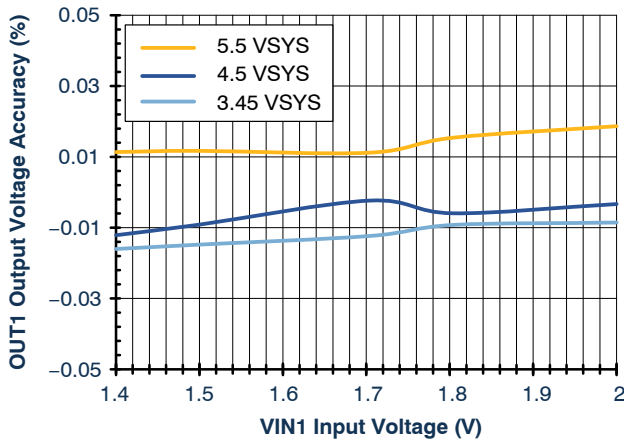

Figure 9. LDO1 Output Voltage Accuracy vs. Input and System Voltage, $V_{\text{OUT1}} = 1.2\text{ V}$ and $I_{\text{OUT1}} = 50\text{ mA}$

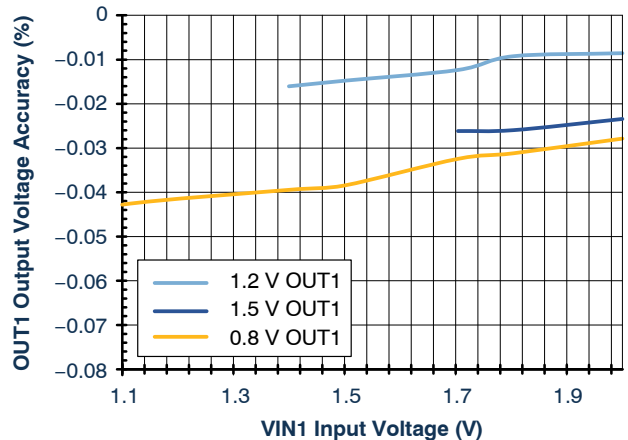

Figure 10. LDO1 Output Voltage Accuracy vs. Input and Output Voltage, $I_{\text{OUT1}} = 50\text{ mA}$

TYPICAL CHARACTERISTICS (continued)

(Unless otherwise noted, $T_A = 25^\circ\text{C}$, For LDO Mode: $V_{\text{SYS}} = 3.45\text{ V}$, $V_{\text{VIN1}} = 1.3\text{ V}$, $V_{\text{VIN2}} = 3.45\text{ V}$, V_{VIN3} and $V_{\text{VIN4}} = 1.95\text{ V}$; For LS Mode: $V_{\text{SYS}} = 3.80\text{ V}$, $V_{\text{VIN1}} = sV_{\text{VIN3}} = V_{\text{VIN4}} = 1.8\text{ V}$ and $V_{\text{VIN2}} = 5.0\text{ V}$. Using components from Recommended External Components.)

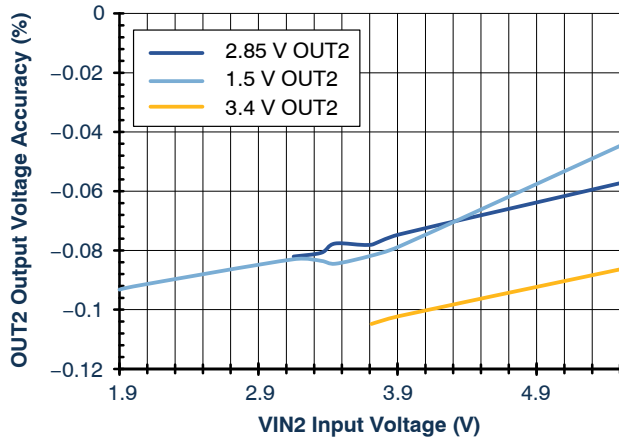

Figure 11. LDO2 Output Voltage Accuracy vs. Input and Output Voltage, $I_{\text{OUT2}} = 50\text{ mA}$

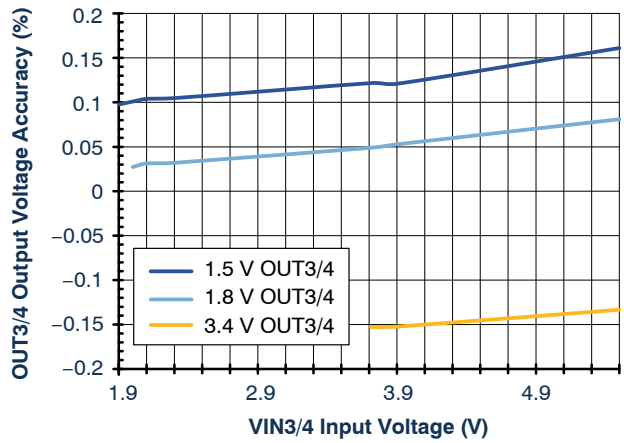

Figure 12. LDO3/4 Output Voltage Accuracy vs. Input and Output Voltage, $I_{\text{OUT3/4}} = 50\text{ mA}$

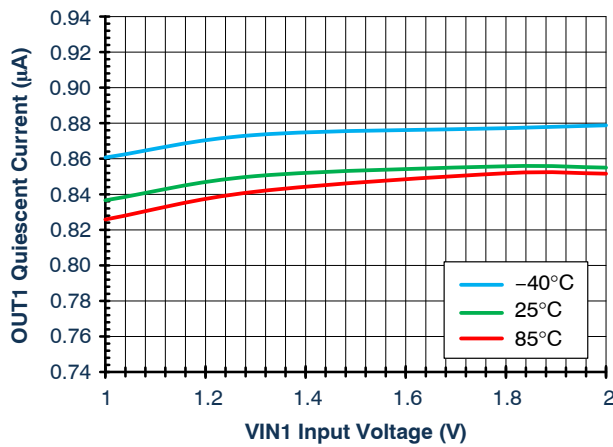

Figure 13. LS1 Quiescent Current vs. Input Voltage and Temperature

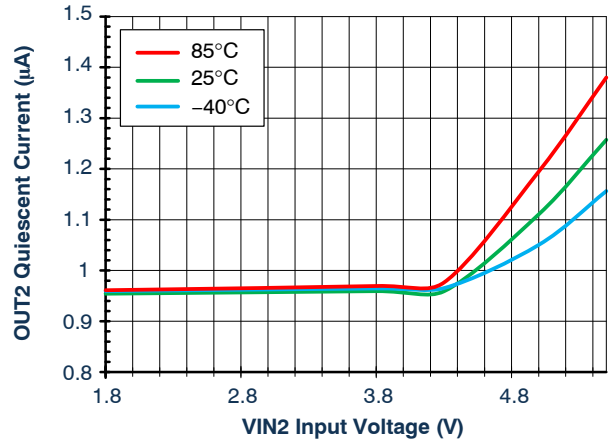

Figure 14. LS2 Quiescent Current vs. Input Voltage and Temperature

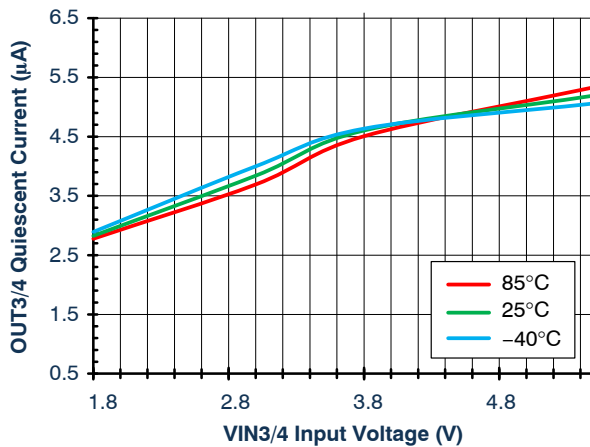

Figure 15. LS3/4 Quiescent Current vs. Input Voltage and Temperature

FAN53840, FAN53841

TYPICAL CHARACTERISTICS (continued)

(Unless otherwise noted, $T_A = 25^\circ\text{C}$, For LDO Mode: $V_{VSYS} = 3.45\text{ V}$, $V_{VIN1} = 1.3\text{ V}$, $V_{VIN2} = 3.45\text{ V}$, V_{VIN3} and $V_{VIN4} = 1.95\text{ V}$; For LS Mode: $V_{VSYS} = 3.80\text{ V}$, $V_{VIN1} = V_{VIN3} = V_{VIN4} = 1.8\text{ V}$ and $V_{VIN2} = 5.0\text{ V}$. Using components from Recommended External Components.)

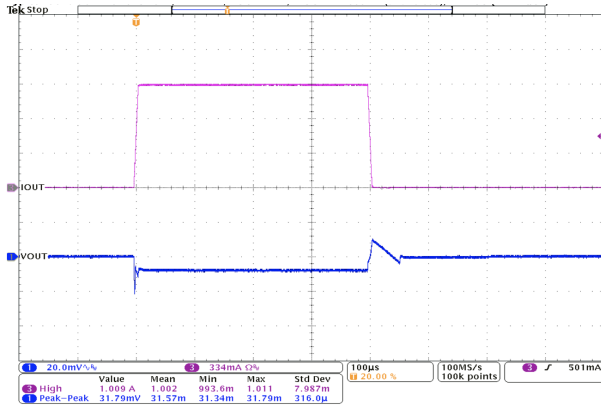

Figure 16. LDO1 Load Transient, $V_{VSYS} = 3.45\text{ V}$, $V_{VIN1} = 1.4\text{ V}$, $V_{OUT1} = 1.2\text{ V}$, $1\text{ mA} \leftrightarrow 1000\text{ mA}$, $6\text{ }\mu\text{s}$ Edge

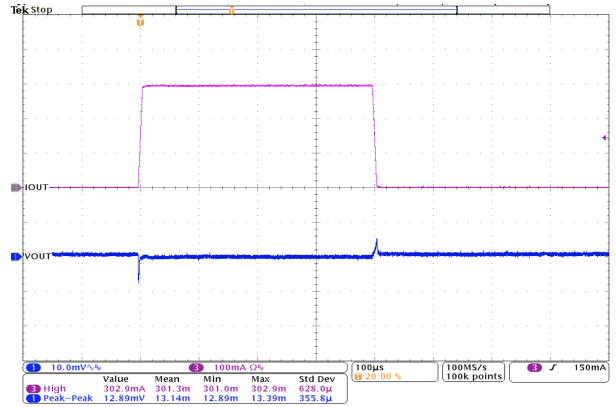

Figure 17. LDO2 Load Transient, $V_{VSYS} = 3.45\text{ V}$, $V_{VIN2} = 3.45\text{ V}$, $V_{OUT2} = 2.85\text{ V}$, $1\text{ mA} \leftrightarrow 300\text{ mA}$, $6\text{ }\mu\text{s}$ Edge

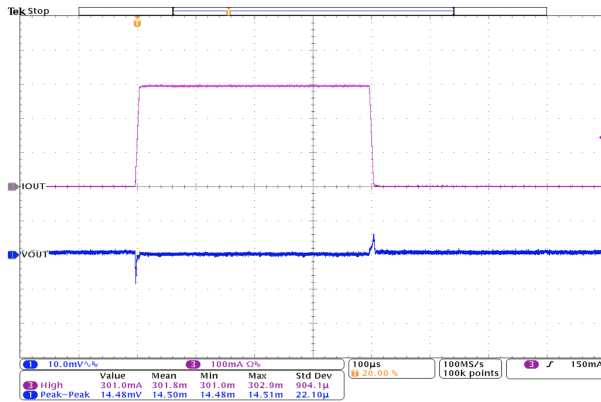

Figure 18. LDO3/4 Load Transient, $V_{VSYS} = 3.45\text{ V}$, $V_{VIN3/4} = 2.0\text{ V}$, $V_{OUT3/4} = 1.8\text{ V}$, $1\text{ mA} \leftrightarrow 300\text{ mA}$, $6\text{ }\mu\text{s}$ Edge

FAN53840, FAN53841

TYPICAL CHARACTERISTICS (continued)

(Unless otherwise noted, $T_A = 25^\circ\text{C}$, For LDO Mode: $V_{V_{SYS}} = 3.45\text{ V}$, $V_{V_{IN1}} = 1.3\text{ V}$, $V_{V_{IN2}} = 3.45\text{ V}$, $V_{V_{IN3}}$ and $V_{V_{IN4}} = 1.95\text{ V}$; For LS Mode: $V_{V_{SYS}} = 3.80\text{ V}$, $V_{V_{IN1}} = V_{V_{IN3}} = V_{V_{IN4}} = 1.8\text{ V}$ and $V_{V_{IN2}} = 5.0\text{ V}$. Using components from Recommended External Components.)



Figure 19. LDO1 PSRR vs. Frequency,
 $V_{OUT1} = 1.2\text{ V}$, $I_{OUT1} = 150\text{ mA}$



Figure 20. LDO1 PSRR vs. Frequency,
 $V_{OUT1} = 1.05\text{ V}$, $I_{OUT1} = 150\text{ mA}$



Figure 21. LDO2 PSRR vs. Frequency,
 $V_{OUT2} = 2.85\text{ V}$, $I_{OUT2} = 100\text{ mA}$

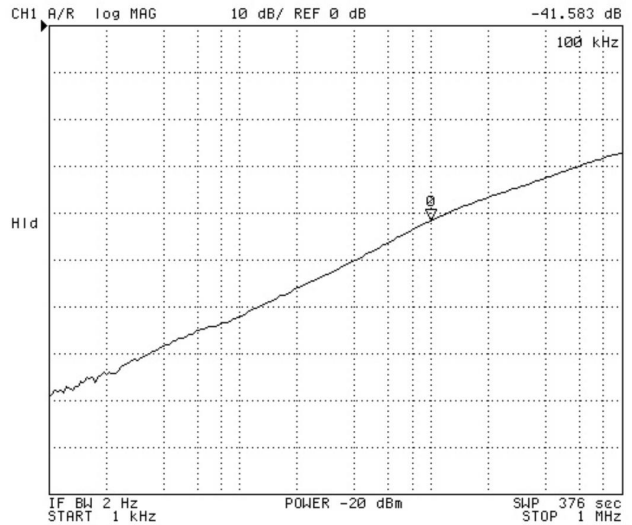

Figure 22. LDO3/4 PSRR vs. Frequency,
 $V_{OUT3/4} = 1.8\text{ V}$, $I_{OUT3/4} = 100\text{ mA}$

FUNCTIONAL SPECIFICATIONS

Device Operation

Overview

The FAN53840 PMIC is optimized to supply different sub systems of battery powered mobile and IoT applications. It integrates four channels that can be set to operate as LDOs or Load-Switches (LS). The LDOs are low-dropout regulators: one high-current and three high PSRR/low noise LDOs. The LS are very low $R_{DS(on)}$ and operate at low currents.

The features of the FAN53840 can be programmed through an I²C interface.

Under Voltage Lockout (UVLO)

The device features system and LDO UVLO protections. When all channels are not selected as LDOs and LS, if the system voltage (V_{sys}) falls below its UVLO falling threshold, system UVLO interrupt and status bits will be set and INT_B asserted low. The status bit will remain set until V_{sys} rises above its UVLO rising threshold. If all LS are selected (By selecting all ldo_lsx bits), no bits will be set; selecting all LS disables system UVLO protection faults. In this state it is possible to operate the four load-switches with their V_{IN} below the range stated in the Recommended Operating Conditions table. This is likely to increase LS $R_{DS(on)}$ and therefore output current derating should be expected.

When enabling LDOs, if V_{sys} is above the Power On Reset (POR) voltage of 2 V but below its UVLO rising threshold, or, if V_{sys} is above its UVLO rising threshold but LDO input voltages are below their UVLO rising thresholds, corresponding UVLO interrupt and status bits will be set and INT_B asserted low. The status bits remain set as long the UVLO fault condition is present.

Similarly, bits and INT_B will be set and asserted low, respectively, when V_{sys} falls below its UVLO falling threshold and channels are not all configured as LS, or, V_{sys} is above its UVLO rising threshold but LDO input voltages fall below their UVLO falling threshold.

In the cases above, the LDOs will not be restarted for a minimum of 20ms and until V_{sys} rises above its rising threshold. Individual LDOs are permanently disabled after four cumulative faults including UVLO faults. The LDOs need to be enabled to return to operation. If the four cumulative faults are a combination of thermal-shutdown and system UVLO faults, then prior to enabling the LDOs, RESET_B pin needs to be toggled from low to high.

Thermal Management

When the die temperature rises to the Thermal Warning (T_{WRN}) threshold, interrupt and status bits indicating thermal-warning are set and INT_B asserted low. The status bit remains set until the die temperature drops to a nominal 105°C.

If the die temperature continues to rise to the Thermal Shutdown threshold, interrupt and status bits indicating thermal-shutdown will be set and INT_B asserted low. All

channels will be disabled but I²C communication will remain. The status bit will remain set until the die temperature drops to T_{WRN} . The chip suspension bit is set upon shutdown.

After the die temperature falls below T_{WRN} , the thermal status and chip suspension bits will be cleared, and the device will return to the operating conditions prior to the thermal-shutdown event. Individual LDOs are permanently disabled after four cumulative faults including thermal faults. If the four cumulative faults are a combination of thermal-shutdown and system UVLO faults, then prior to enabling the LDOs, RESET_B pin needs to be toggled from low to high.

Similarly to system UVLO, selecting all LS will render thermal protection faults inactive.

Enabling/Disabling

The channels can be enabled and disabled independently with the ldox_en bits. To enable LDOs, with RESET_B set high, select desired ldox_en bits while setting *all* ldo_lsx bits to “0”. The LDOs have internal soft-start which limits the inrush current to the current-limit setting of the LDO. The LDOs will ignore faults during the first 1.5 ms while starting-up.

To enable LS, with RESET_B set high, select desired ldox_en bits while setting *all* ldo_lsx bits to “1”. The ldox_en and ldo_lsx bits can be found in the ENABLE and LDO_LS_SELECT registers, respectively.

The device features active discharge. This feature is enabled through the ldox_discharge_enabled bits. A 100 Ω resistor is connected internally between channel outputs and GND to discharge the output capacitors. The ldox_discharge_enabled bits can be found in the ENABLE register.

To do a global shutdown of all channels, set RESET_B pin to low.

It is not recommended to change configuration from LS to LDO operation while the output is loaded. The channel will attempt a restart and the output may drop significantly. It is recommended to first de-select the channels (with ldox_en bits), de-select *all* ldo_lsx bits, then select the channels for LDO operation.

Over-Current Protection (OCP)

The LDOs are protected from short-circuits and excessive loads. When a short-circuit or excessive load condition occurs on an output, the current is limited to the Current Limit value of the LDO and, depending on the difference between input and programmed output voltage, the output voltage may drop. The resultant output voltage is the product of Current Limit and load impedance.

When a current-limit event is detected, the LDOs' associated OCP status bit is set. If the LDO remains in current-limit for 1 ms, the corresponding interrupt bit is set and INT_B asserted low. The LDO will be shutdown and a restarts attempted every 20 ms. Individual LDOs are

permanently disabled after four cumulative faults including OCP faults. The LDOs need to be enabled to return to operation.

Multiple Fault Shutdown

To prevent repetitive starting and faulting of an LDO or of the IC itself, detection of four faults will result in a complete shutdown of an LDO or, if system faults, the IC will shutdown.

Individual LDO Fault: the LDO will be shutdown after the fourth fault for any combination of UVLO and/or OCP faults. The LDO will automatically be de-selected and will require enabling to return to operation.

System Fault: all channels will be shutdown after the fourth chip fault for any combination of thermal-shutdown and/or system UVLO faults. All channels will automatically be de-selected. Enabling of the channels will require RESET_B pin to be toggled from low to high first.

Reset

When the RESET_B pin is pulled LOW, the INTERRUPTx and STATUSx bits will be cleared. All the other registers will remain set to their programmed values, but I²C communication with the device is disabled. Additionally, all internal fault counters will reset to 0.

When the RESET_B pin is pulled HIGH, the I²C block is turned on. The Reset_B pin should not be asserted high while there is data transmission on the I²C bus. This will ensure the FAN53840 doesn't mis-interpret a logic low on SDA as a falling edge and inadvertently create a "Start" condition, and unintended data written to the FAN53840 registers. It is recommended that the FAN53840 is enabled when there is a brief break in I²C data transmissions.

The SOFT_RESET bits in the RESET register can be used to clear all registers to their default values.

No Fault Shutdown

When No Fault Shutdown feature is selected, LDOs are prevented from shutting down during an OCP event but are not prevented from shutting down due to a UVLO fault event. When these events occur, the interrupt and status bits will indicate a fault but the fault counter will not be incremented.

This feature is activated by setting no_fault_shutdown bit in RESET register to "1".

I²C Functionality

I²C Interface

The FAN53840 serial interface is compatible with Standard, Fast and Fast Plus Mode I²C Bus specifications. The SCL line is an input and its SDA line is a bi-directional open-drain output; it can only pull down the bus when active. The SDA line only pulls LOW during data reads and when signaling ACK. All data is shifted in MSB (bit 7) first.

Please refer to the *Reset* section for guidance on RESET_B LOW to HIGH pin timing for proper enabling of the I²C block.

I²C Slave Address

The FAN53840 provides three different I²C addresses. The addresses can be set by connecting the ADDR pin according to the settings in Table 2. Depending on the setting of the ADDR Pin when RESET_B is asserted high, the device address will be selected. To reset the address, disable the device by pulling RESET_B low. Reconfigure the ADDR pin to the desired setting then enable the device by asserting RESET_B high.

The I²C is accessible approximately 300 μs after enabling the device through asserting RESET_B high. For reliable reads of the ADDR pin setting, it is recommended for ADDR pin not to change states during the 300 μs detection period. Providing the system power pin voltage does not fall below POR level, register values will be retained while RESET_B pin is maintained low.

A precautionary measure: registers should be reprogrammed to desired values anytime a system UVLO fault is detected.

Other default slave addresses can be accommodated by contacting an **onsemi** representative.

Table 2. I²C SLAVE ADDRESS

C3, ADDR Pin Connected to	Address
VSYS	7'h72
Floating	7'h61
Ground	7'h20

Bus Timing

As shown in Figure 23, data is normally transferred when SCL is LOW. Data is clocked in on the rising edge of SCL. Typically, data transitions shortly at or after the falling edge of SCL to allow ample time for the data to set up before the next SCL rising edge.

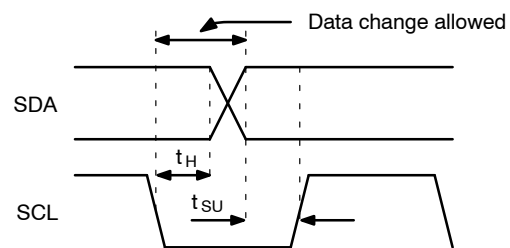

Figure 23. Data Transfer Timing

Each bus transaction begins and ends with SDA and SCL HIGH. A transaction begins with a START condition, which is defined as SDA transitioning from 1 to 0 with SCL HIGH, as shown in Figure 24.

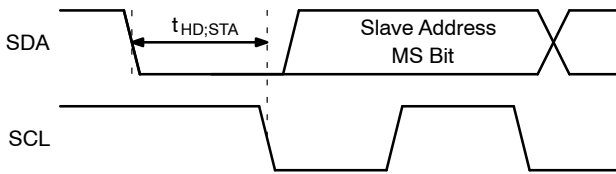

Figure 24. Start Bit

Transactions end with a STOP condition, which is SDA transitioning from 0 to 1 with SCL HIGH, as shown in Figure 25.

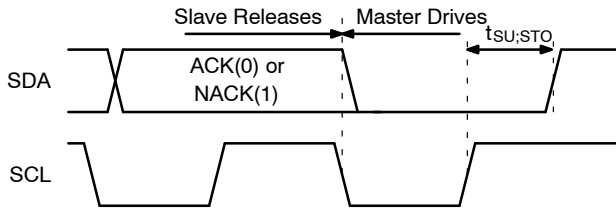

Figure 25. Stop Bit

During a read from the FAN53840, the master issues a Repeated Start after sending the register address and before resending the slave address. The Repeated Start is a 1-to-0 transition on SDA while SCL is HIGH, as shown in Figure 26.

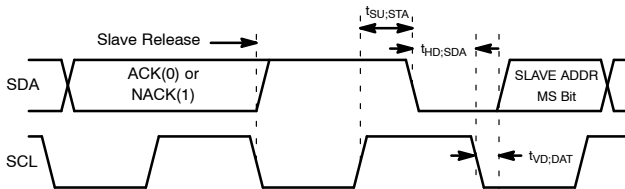

Figure 26. Repeated Start Timing

Read and Write Transactions

The figures below outline the sequences for data read and write. Bus control is signified by the shading of the packet, defined as Master Drives Bus and Slave Drives Bus. All addresses and data are MSB first.

Multi-Byte (Sequential) Read and Write Transactions

Sequential Write (Figure 29)

The Slave Address, Reg Addr address, and the first data byte are transmitted to the FAN53840 in the same way as in a single-byte write (Figure 27). However, instead of generating a Stop condition, the master transmits additional bytes that are written to consecutive sequential registers after the falling edge of the eighth bit. After the last byte written and its ACK bit received, the master issues a STOP bit. The IC contains an 8-bit counter that increments the address pointer after each byte is written.

Sequential Read (Figure 30)

Sequential reads are initiated in the same way as a single-byte read (Figure 28), except that once the slave transmits the first data byte, the master issues an acknowledge instead of a STOP condition. This directs the slave's I²C logic to transmit the next sequentially addressed 8-bit word. The FAN53840 contains an 8-bit counter that increments the address pointer after each byte is read, which allows the entire memory contents to be read during one I²C transaction.



Figure 27. Single-Byte Write Transaction



Figure 28. Single-Byte Read Transaction

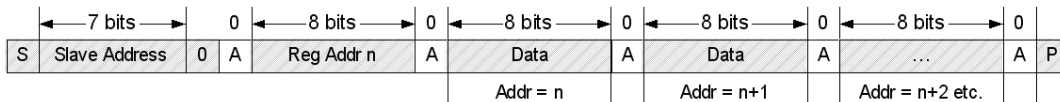

Figure 29. Multi-Byte (Sequential) Write Transaction

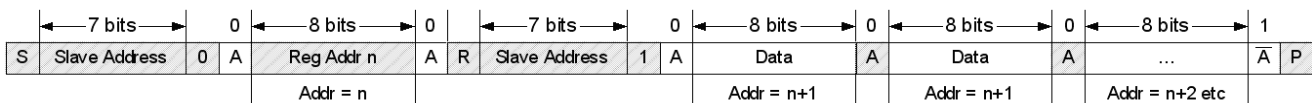

Figure 30. Multi-Byte (Sequential) Read Transaction

FAN53840, FAN53841

REGISTER MAPPING TABLE

Table 3. REGISTER MAPPING

					Read Only	Write Only	Read/Write	Read/Clear	Write/Clear	
Address	Name	Bit[7]	Bit[6]	Bit[5]	Bit[4]	Bit[3]	Bit[2]	Bit[1]	Bit[0]	
0x00	PRODUCT ID	Product ID								
0x01	SILICON REV ID	Revision								
0x02	ENABLE	OUT4_DIS	OUT3_DIS	OUT2_DIS	OUT1_DIS	CHAN4_EN	CHAN3_EN	CHAN2_EN	CHAN1_EN	
0x03	CHAN1	UNUSED	LDO1_VOUT							
0x04	CHAN2	LDO2_VOUT								
0x05	CHAN3	LDO3_VOUT								
0x06	CHAN4	LDO4_VOUT								
0x07	RESET	SOFT_RESET				UNUSED	OCP_TIMER		FLT_SD_B	
0x08	LDO_COMP0	LDO4_COMP_SEL		LDO3_COMP_SEL		LDO2_COMP_SEL		LDO1_COMP_SEL		
0x09	INTERRUPT1	UNUSED	UNUSED	UNUSED	UNUSED	LDO4_OCP_INT	LDO3_OCP_INT	LDO2_OCP_INT	LDO1_OCP_INT	
0x0A	INTERRUPT2	UNUSED	TSD_INT	TSD_WRN_INT	VSYS_UVLO_INT	CHAN4_UVLO_INT	CHAN3_UVLO_INT	CHAN2_UVLO_INT	CHAN1_UVLO_INT	
0x0B	STATUS1	UNUSED	UNUSED	UNUSED	UNUSED	LDO4_OCP_STAT	LDO3_OCP_STAT	LDO2_OCP_STAT	LDO1_OCP_STAT	
0x0C	STATUS2	UNUSED	TSD_STAT	TSD_WRN_STAT	VSYS_UVLO_STAT	CHAN4_UVLO_STAT	CHAN3_UVLO_STAT	CHAN2_UVLO_STAT	CHAN1_UVLO_STAT	
0x0D	STATUS3	UNUSED	UNUSED	UNUSED	CHIP_SUSD	CHAN4_SUSD	CHAN3_SUSD	CHAN2_SUSD	CHAN1_SUSD	
0x0E	MINT1	UNUSED	UNUSED	UNUSED	UNUSED	MASK_LDO4_OCP	MASK_LDO3_OCP	MASK_LDO2_OCP	MASK_LDO1_OCP	
0x0F	MINT2	UNUSED	MASK_TSD	MASK_TSD_WRN	MASK_VSYS_UVLO	MASK_CHAN4_UVLO	MASK_CHAN3_UVLO	MASK_CHAN2_UVLO	MASK_CHAN1_UVLO	
0x10	LDO_LS_SELECT	UNUSED	UNUSED	UNUSED	UNUSED	LDO_LS4_SELECT	LDO_LS3_SELECT	LDO_LS2_SELECT	LDO_LS1_SELECT	

FAN53840, FAN53841

REGISTER DETAILS

Table 4. REGISTER DETAILS – 0x00 PRODUCT ID

0x00 PRODUCT ID				Default = 00000001	
Bit	Name	Default	Type	Description	
7:0	Product ID	00000001	Read	Allows Customers to Identify Manufacturer and Version	
				Product ID Table	
				Code	Product
				00000000	-
				00000001	FAN53840
				00000010	Reserved
				00000011	Reserved
				00000100	Reserved
				00000101	Reserved
				00000110	Reserved
				00000111	Reserved
				00001000	Reserved
				00001001	Reserved
				00001010	Reserved
				00001011	Reserved
				00001100	Reserved
				00001101	Reserved
				00001110	Reserved
00001111	Reserved				

Table 5. REGISTER DETAILS – 0X01 SILICON REV ID

0x01 SILICON REV ID				Default = 00000000		
Bit	Name	Default	Type	Description		
7:0	Revision	00000000	Read	Provides the Silicon Revision		
				REG 01 [7:0] SILICON REV ID	REG 84 [3:0] INTERNAL REVISION	Revision
				00000000	0000	A_REVA
				00000001	0001	
				00000010	0010	
				00000011	0011	
00000100	0100					

FAN53840, FAN53841

Table 6. REGISTER DETAILS – 0X02 ENABLE

0x02 ENABLE				Default = 00000000	
Bit	Name	Default	Type	Description	
7	OUT4_DIS	0	R/W	Code	Discharge Enabled/Disabled
				0	OUT4 Active Discharge feature is disabled. Pull down will not be activated when OUT4 is disabled by any event.
				1	OUT4 Active Discharge feature is enabled. See description of Active Pulldowns in the Device Operation.
6	OUT3_DIS	0	R/W	Code	Discharge Enabled/Disabled
				0	OUT3 Active Discharge feature is disabled. Pull down will not be activated when LDO3 is disabled by any event.
				1	OUT3 Active Discharge feature is enabled. See description of Active Pulldowns in the Device Operation.
5	OUT2_DIS	0	R/W	Code	Discharge Enabled/Disabled
				0	OUT2 Active Discharge feature is disabled. Pull down will not be activated when LDO2 is disabled by any event.
				1	OUT2 Active Discharge feature is enabled. See description of Active Pulldowns in the Device Operation.
4	OUT1_DIS	0	R/W	Code	Discharge Enabled/Disabled
				0	OUT1 Active Discharge feature is disabled. Pull down will not be activated when LDO1 is disabled by any event.
				1	OUT1 Active Discharge feature is enabled. See description of Active Pulldowns in the Device Operation.
3	CHAN4_EN	0	R/W	Enable bit for CHAN #4.	
				Code	Status of CHAN4
				0	Disabled
				1	Enabled
2	CHAN3_EN	0	R/W	Enable bit for CHAN #3.	
				Code	Status of CHAN3
				0	Disabled
				1	Enabled
1	CHAN2_EN	0	R/W	Enable bit for CHAN #2.	
				Code	Status of CHAN2
				0	Disabled
				1	Enabled
0	CHAN1_EN	0	R/W	Enable bit for CHAN #1.	
				Code	Status of CHAN1
				0	Disabled
				1	Enabled

FAN53840, FAN53841

Table 7. REGISTER DETAILS – 0X03 CHAN1

0x03 CHAN1				Default = 00000000																																																																																																																																												
Bit	Name	Default	Type	Description																																																																																																																																												
7	UNUSED	0	Read																																																																																																																																													
6:0	LDO1_VOUT	00000000	R/W	When LDO_LS1_SELECT bit is set to “0”, these register bits sets LDO1 regulation target voltage. Equation: $V_{out} = 0.800\text{ V} + [(d - 35) * 8\text{ mV}]$; Where d is the decimal value of the register. The Default (00000000) points to the OTP programmed default value. If this register is not reprogrammed, a read of the register will return 00h.																																																																																																																																												
				<table border="1"> <thead> <tr> <th>Hex</th> <th>VOUT</th> <th>Hex</th> <th>VOUT</th> </tr> </thead> <tbody> <tr><td>00</td><td>DEFAULT</td><td>40</td><td>1.032 V</td></tr> <tr><td>01</td><td>Reserved</td><td>41</td><td>1.040 V</td></tr> <tr><td>02</td><td>Reserved</td><td>42</td><td>1.048 V</td></tr> <tr><td>03</td><td>Reserved</td><td>43</td><td>1.056 V</td></tr> <tr><td>04</td><td>Reserved</td><td>44</td><td>1.064 V</td></tr> <tr><td>05</td><td>Reserved</td><td>45</td><td>1.072 V</td></tr> <tr><td>06</td><td>Reserved</td><td>46</td><td>1.080 V</td></tr> <tr><td>07</td><td>Reserved</td><td>47</td><td>1.088 V</td></tr> <tr><td>08</td><td>Reserved</td><td>48</td><td>1.096 V</td></tr> <tr><td>09</td><td>Reserved</td><td>49</td><td>1.104 V</td></tr> <tr><td>0A</td><td>Reserved</td><td>4A</td><td>1.112 V</td></tr> <tr><td>0B</td><td>Reserved</td><td>4B</td><td>1.120 V</td></tr> <tr><td>0C</td><td>Reserved</td><td>4C</td><td>1.128 V</td></tr> <tr><td>0D</td><td>Reserved</td><td>4D</td><td>1.136 V</td></tr> <tr><td>0E</td><td>Reserved</td><td>4E</td><td>1.144 V</td></tr> <tr><td>0F</td><td>Reserved</td><td>4F</td><td>1.152 V</td></tr> <tr><td>10</td><td>Reserved</td><td>50</td><td>1.160 V</td></tr> <tr><td>11</td><td>Reserved</td><td>51</td><td>1.168 V</td></tr> <tr><td>12</td><td>Reserved</td><td>52</td><td>1.176 V</td></tr> <tr><td>13</td><td>Reserved</td><td>53</td><td>1.184 V</td></tr> <tr><td>14</td><td>Reserved</td><td>54</td><td>1.192 V</td></tr> <tr><td>15</td><td>Reserved</td><td>55</td><td>1.200 V</td></tr> <tr><td>16</td><td>Reserved</td><td>56</td><td>1.208 V</td></tr> <tr><td>17</td><td>Reserved</td><td>57</td><td>1.216 V</td></tr> <tr><td>18</td><td>Reserved</td><td>58</td><td>1.224 V</td></tr> <tr><td>19</td><td>Reserved</td><td>59</td><td>1.232 V</td></tr> <tr><td>1A</td><td>Reserved</td><td>5A</td><td>1.240 V</td></tr> <tr><td>1B</td><td>Reserved</td><td>5B</td><td>1.248 V</td></tr> <tr><td>1C</td><td>Reserved</td><td>5C</td><td>1.256 V</td></tr> <tr><td>1D</td><td>Reserved</td><td>5D</td><td>1.264 V</td></tr> <tr><td>1E</td><td>Reserved</td><td>5E</td><td>1.272 V</td></tr> <tr><td>1F</td><td>Reserved</td><td>5F</td><td>1.280 V</td></tr> <tr><td>20</td><td>Reserved</td><td>60</td><td>1.288 V</td></tr> <tr><td>21</td><td>Reserved</td><td>61</td><td>1.296 V</td></tr> </tbody> </table>	Hex	VOUT	Hex	VOUT	00	DEFAULT	40	1.032 V	01	Reserved	41	1.040 V	02	Reserved	42	1.048 V	03	Reserved	43	1.056 V	04	Reserved	44	1.064 V	05	Reserved	45	1.072 V	06	Reserved	46	1.080 V	07	Reserved	47	1.088 V	08	Reserved	48	1.096 V	09	Reserved	49	1.104 V	0A	Reserved	4A	1.112 V	0B	Reserved	4B	1.120 V	0C	Reserved	4C	1.128 V	0D	Reserved	4D	1.136 V	0E	Reserved	4E	1.144 V	0F	Reserved	4F	1.152 V	10	Reserved	50	1.160 V	11	Reserved	51	1.168 V	12	Reserved	52	1.176 V	13	Reserved	53	1.184 V	14	Reserved	54	1.192 V	15	Reserved	55	1.200 V	16	Reserved	56	1.208 V	17	Reserved	57	1.216 V	18	Reserved	58	1.224 V	19	Reserved	59	1.232 V	1A	Reserved	5A	1.240 V	1B	Reserved	5B	1.248 V	1C	Reserved	5C	1.256 V	1D	Reserved	5D	1.264 V	1E	Reserved	5E	1.272 V	1F	Reserved	5F	1.280 V	20	Reserved	60	1.288 V	21	Reserved	61	1.296 V
				Hex	VOUT	Hex	VOUT																																																																																																																																									
				00	DEFAULT	40	1.032 V																																																																																																																																									
				01	Reserved	41	1.040 V																																																																																																																																									
				02	Reserved	42	1.048 V																																																																																																																																									
				03	Reserved	43	1.056 V																																																																																																																																									
				04	Reserved	44	1.064 V																																																																																																																																									
				05	Reserved	45	1.072 V																																																																																																																																									
				06	Reserved	46	1.080 V																																																																																																																																									
				07	Reserved	47	1.088 V																																																																																																																																									
				08	Reserved	48	1.096 V																																																																																																																																									
				09	Reserved	49	1.104 V																																																																																																																																									
				0A	Reserved	4A	1.112 V																																																																																																																																									
				0B	Reserved	4B	1.120 V																																																																																																																																									
				0C	Reserved	4C	1.128 V																																																																																																																																									
				0D	Reserved	4D	1.136 V																																																																																																																																									
				0E	Reserved	4E	1.144 V																																																																																																																																									
				0F	Reserved	4F	1.152 V																																																																																																																																									
				10	Reserved	50	1.160 V																																																																																																																																									
				11	Reserved	51	1.168 V																																																																																																																																									
				12	Reserved	52	1.176 V																																																																																																																																									
13	Reserved	53	1.184 V																																																																																																																																													
14	Reserved	54	1.192 V																																																																																																																																													
15	Reserved	55	1.200 V																																																																																																																																													
16	Reserved	56	1.208 V																																																																																																																																													
17	Reserved	57	1.216 V																																																																																																																																													
18	Reserved	58	1.224 V																																																																																																																																													
19	Reserved	59	1.232 V																																																																																																																																													
1A	Reserved	5A	1.240 V																																																																																																																																													
1B	Reserved	5B	1.248 V																																																																																																																																													
1C	Reserved	5C	1.256 V																																																																																																																																													
1D	Reserved	5D	1.264 V																																																																																																																																													
1E	Reserved	5E	1.272 V																																																																																																																																													
1F	Reserved	5F	1.280 V																																																																																																																																													
20	Reserved	60	1.288 V																																																																																																																																													
21	Reserved	61	1.296 V																																																																																																																																													

FAN53840, FAN53841

Table 7. REGISTER DETAILS – 0X03 CHAN1 (continued)

0x03 CHAN1				Default = 0000000			
Bit	Name	Default	Type	Description			
6:0	LDO1_VOUT	0000000	R/W	22	Reserved	62	1.304 V
				23	0.800 V	63	1.312 V
				24	0.808 V	64	1.320 V
				25	0.816 V	65	1.328 V
				26	0.824 V	66	1.336 V
				27	0.832 V	67	1.344 V
				28	0.840 V	68	1.352 V
				29	0.848 V	69	1.360 V
				2A	0.856 V	6A	1.368 V
				2B	0.864 V	6B	1.376 V
				2C	0.872 V	6C	1.384 V
				2D	0.880 V	6D	1.392 V
				2E	0.888 V	6E	1.400 V
				2F	0.896 V	6F	1.408 V
				30	0.904 V	70	1.416 V
				31	0.912 V	71	1.424 V
				32	0.920 V	72	1.432 V
				33	0.928 V	73	1.440 V
				34	0.936 V	74	1.448 V
				35	0.944 V	75	1.456 V
				36	0.952 V	76	1.464 V
				37	0.960 V	77	1.472 V
				38	0.968 V	78	1.480 V
				39	0.976 V	79	1.488 V
				3A	0.984 V	7A	1.496 V
				3B	0.992 V	7B	1.504 V
				3C	1.000 V	7C	Reserved
				3D	1.008 V	7D	Reserved
				3E	1.016 V	7E	Reserved
				3F	1.024 V	7F	Reserved

FAN53840, FAN53841

Table 8. REGISTER DETAILS – 0X04 CHAN2

0x04 CHAN2				Default = 00000000							
Bit	Name	Default	Type	Description							
7:0	LDO2_VOUT	00000000	R/W	When LDO_LS2_SELECT bit is set to "0", these register bits sets LDO2 regulation target voltage. Equation: $V_{out} = 1.500\text{ V} + [(d - 16) * 8\text{ mV}]$; where d is the decimal value of the register. The Default (00h) points to the OTP programmed default value. If this register is not reprogrammed, a read of the register will return 00h.							
				Hex	VOUT	Hex	VOUT	Hex	VOUT	Hex	VOUT
				00	DEFAULT	40	1.884 V	80	2.396 V	C0	2.908 V
				01	Reserved	41	1.892 V	81	2.404 V	C1	2.916 V
				02	Reserved	42	1.900 V	82	2.412 V	C2	2.924 V
				03	Reserved	43	1.908 V	83	2.420 V	C3	2.932 V
				04	Reserved	44	1.916 V	84	2.428 V	C4	2.940 V
				05	Reserved	45	1.924 V	85	2.436 V	C5	2.948 V
				06	Reserved	46	1.932 V	86	2.444 V	C6	2.956 V
				07	Reserved	47	1.940 V	87	2.452 V	C7	2.964 V
				08	Reserved	48	1.948 V	88	2.460 V	C8	2.972 V
				09	Reserved	49	1.956 V	89	2.468 V	C9	2.980 V
				0A	Reserved	4A	1.964 V	8A	2.476 V	CA	2.988 V
				0B	Reserved	4B	1.972 V	8B	2.484 V	CB	2.996 V
				0C	Reserved	4C	1.980 V	8C	2.492 V	CC	3.004 V
				0D	Reserved	4D	1.988 V	8D	2.500 V	CD	3.012 V
				0E	Reserved	4E	1.996 V	8E	2.508 V	CE	3.020 V
				0F	Reserved	4F	2.004 V	8F	2.516 V	CF	3.028 V
				10	1.500 V	50	2.012 V	90	2.524 V	D0	3.036 V
				11	1.508 V	51	2.020 V	91	2.532 V	D1	3.044 V
				12	1.516 V	52	2.028 V	92	2.540 V	D2	3.052 V
				13	1.524 V	53	2.036 V	93	2.548 V	D3	3.060 V
				14	1.532 V	54	2.044 V	94	2.556 V	D4	3.068 V
				15	1.540 V	55	2.052 V	95	2.564 V	D5	3.076 V
				16	1.548 V	56	2.060 V	96	2.572 V	D6	3.084 V
				17	1.556 V	57	2.068 V	97	2.580 V	D7	3.092 V
				18	1.564 V	58	2.076 V	98	2.588 V	D8	3.100 V
				19	1.572 V	59	2.084 V	99	2.596 V	D9	3.108 V
				1A	1.580 V	5A	2.092 V	9A	2.604 V	DA	3.116 V
				1B	1.588 V	5B	2.100 V	9B	2.612 V	DB	3.124 V
				1C	1.596 V	5C	2.108 V	9C	2.620 V	DC	3.132 V
				1D	1.604 V	5D	2.116 V	9D	2.628 V	DD	3.140 V
				1E	1.612 V	5E	2.124 V	9E	2.636 V	DE	3.148 V
				1F	1.620 V	5F	2.132 V	9F	2.644 V	DF	3.156 V
				20	1.628 V	60	2.140 V	A0	2.652 V	E0	3.164 V
				21	1.636 V	61	2.148 V	A1	2.660 V	E1	3.172 V
				22	1.644 V	62	2.156 V	A2	2.668 V	E2	3.180 V
				23	1.652 V	63	2.164 V	A3	2.676 V	E3	3.188 V
				24	1.660 V	64	2.172 V	A4	2.684 V	E4	3.196 V
				25	1.668 V	65	2.180 V	A5	2.692 V	E5	3.204 V

FAN53840, FAN53841

Table 8. REGISTER DETAILS – 0X04 CHAN2 (continued)

0x04 CHAN2				Default = 0000000							
Bit	Name	Default	Type	Description							
				26	1.676 V	66	2.188 V	A6	2.700 V	E6	3.212 V
				27	1.684 V	67	2.196 V	A7	2.708 V	E7	3.220 V
				28	1.692 V	68	2.204 V	A8	2.716 V	E8	3.228 V
				29	1.700 V	69	2.212 V	A9	2.724 V	E9	3.236 V
				2A	1.708 V	6A	2.220 V	AA	2.732 V	EA	3.244 V
				2B	1.716 V	6B	2.228 V	AB	2.740 V	EB	3.252 V
				2C	1.724 V	6C	2.236 V	AC	2.748 V	EC	3.260 V
				2D	1.732 V	6D	2.244 V	AD	2.756 V	ED	3.268 V
				2E	1.740 V	6E	2.252 V	AE	2.764 V	EE	3.276 V
				2F	1.748 V	6F	2.260 V	AF	2.772 V	EF	3.284 V
				30	1.756 V	70	2.268 V	B0	2.780 V	F0	3.292 V
				31	1.764 V	71	2.276 V	B1	2.788 V	F1	3.300 V
				32	1.772 V	72	2.284 V	B2	2.796 V	F2	3.308 V
				33	1.780 V	73	2.292 V	B3	2.804 V	F3	3.316 V
				34	1.788 V	74	2.300 V	B4	2.812 V	F4	3.324 V
				35	1.796 V	75	2.308 V	B5	2.820 V	F5	3.332 V
				36	1.804 V	76	2.316 V	B6	2.828 V	F6	3.340 V
				37	1.812 V	77	2.324 V	B7	2.836 V	F7	3.348 V
				38	1.820 V	78	2.332 V	B8	2.844 V	F8	3.356 V
				39	1.828 V	79	2.340 V	B9	2.852 V	F9	3.364 V
				3A	1.836 V	7A	2.348 V	BA	2.860 V	FA	3.372 V
				3B	1.844 V	7B	2.356 V	BB	2.868 V	FB	3.380 V
				3C	1.852 V	7C	2.364 V	BC	2.876 V	FC	3.388 V
				3D	1.860 V	7D	2.372 V	BD	2.884 V	FD	3.396 V
				3E	1.868 V	7E	2.380 V	BE	2.892 V	FE	3.404 V
				3F	1.876 V	7F	2.388 V	BF	2.900 V	FF	3.412 V

FAN53840, FAN53841

Table 9. REGISTER DETAILS – 0X05 CHAN3

0x05 CHAN3				Default = 00000000							
Bit	Name	Default	Type	Description							
7:0	LDO3_VOUT	00000000	R/W	When LDO_LS3_SELECT bit is set to "0", these register bits sets LDO3 regulation target voltage. Equation: $V_{out} = 1.500\text{ V} + [(d - 16) * 8\text{ mV}]$; where d is the decimal value of the register. The Default (00h) points to the OTP programmed default value. If this register is not reprogrammed, a read of the register will return 00h.							
				Hex	VOUT	Hex	VOUT	Hex	VOUT	Hex	VOUT
				00	DEFAULT	40	1.884 V	80	2.396 V	C0	2.908 V
				01	Reserved	41	1.892 V	81	2.404 V	C1	2.916 V
				02	Reserved	42	1.900 V	82	2.412 V	C2	2.924 V
				03	Reserved	43	1.908 V	83	2.420 V	C3	2.932 V
				04	Reserved	44	1.916 V	84	2.428 V	C4	2.940 V
				05	Reserved	45	1.924 V	85	2.436 V	C5	2.948 V
				06	Reserved	46	1.932 V	86	2.444 V	C6	2.956 V
				07	Reserved	47	1.940 V	87	2.452 V	C7	2.964 V
				08	Reserved	48	1.948 V	88	2.460 V	C8	2.972 V
				09	Reserved	49	1.956 V	89	2.468 V	C9	2.980 V
				0A	Reserved	4A	1.964 V	8A	2.476 V	CA	2.988 V
				0B	Reserved	4B	1.972 V	8B	2.484 V	CB	2.996 V
				0C	Reserved	4C	1.980 V	8C	2.492 V	CC	3.004 V
				0D	Reserved	4D	1.988 V	8D	2.500 V	CD	3.012 V
				0E	Reserved	4E	1.996 V	8E	2.508 V	CE	3.020 V
				0F	Reserved	4F	2.004 V	8F	2.516 V	CF	3.028 V
				10	1.500 V	50	2.012 V	90	2.524 V	D0	3.036 V
				11	1.508 V	51	2.020 V	91	2.532 V	D1	3.044 V
				12	1.516 V	52	2.028 V	92	2.540 V	D2	3.052 V
				13	1.524 V	53	2.036 V	93	2.548 V	D3	3.060 V
				14	1.532 V	54	2.044 V	94	2.556 V	D4	3.068 V
				15	1.540 V	55	2.052 V	95	2.564 V	D5	3.076 V
				16	1.548 V	56	2.060 V	96	2.572 V	D6	3.084 V
				17	1.556 V	57	2.068 V	97	2.580 V	D7	3.092 V
				18	1.564 V	58	2.076 V	98	2.588 V	D8	3.100 V
				19	1.572 V	59	2.084 V	99	2.596 V	D9	3.108 V
				1A	1.580 V	5A	2.092 V	9A	2.604 V	DA	3.116 V
				1B	1.588 V	5B	2.100 V	9B	2.612 V	DB	3.124 V
				1C	1.596 V	5C	2.108 V	9C	2.620 V	DC	3.132 V
				1D	1.604 V	5D	2.116 V	9D	2.628 V	DD	3.140 V
				1E	1.612 V	5E	2.124 V	9E	2.636 V	DE	3.148 V
				1F	1.620 V	5F	2.132 V	9F	2.644 V	DF	3.156 V
				20	1.628 V	60	2.140 V	A0	2.652 V	E0	3.164 V
				21	1.636 V	61	2.148 V	A1	2.660 V	E1	3.172 V
				22	1.644 V	62	2.156 V	A2	2.668 V	E2	3.180 V
				23	1.652 V	63	2.164 V	A3	2.676 V	E3	3.188 V
				24	1.660 V	64	2.172 V	A4	2.684 V	E4	3.196 V
				25	1.668 V	65	2.180 V	A5	2.692 V	E5	3.204 V

FAN53840, FAN53841

Table 9. REGISTER DETAILS – 0X05 CHAN3 (continued)

0x05 CHAN3				Default = 0000000							
Bit	Name	Default	Type	Description							
				26	1.676 V	66	2.188 V	A6	2.700 V	E6	3.212 V
				27	1.684 V	67	2.196 V	A7	2.708 V	E7	3.220 V
				28	1.692 V	68	2.204 V	A8	2.716 V	E8	3.228 V
				29	1.700 V	69	2.212 V	A9	2.724 V	E9	3.236 V
				2A	1.708 V	6A	2.220 V	AA	2.732 V	EA	3.244 V
				2B	1.716 V	6B	2.228 V	AB	2.740 V	EB	3.252 V
				2C	1.724 V	6C	2.236 V	AC	2.748 V	EC	3.260 V
				2D	1.732 V	6D	2.244 V	AD	2.756 V	ED	3.268 V
				2E	1.740 V	6E	2.252 V	AE	2.764 V	EE	3.276 V
				2F	1.748 V	6F	2.260 V	AF	2.772 V	EF	3.284 V
				30	1.756 V	70	2.268 V	B0	2.780 V	F0	3.292 V
				31	1.764 V	71	2.276 V	B1	2.788 V	F1	3.300 V
				32	1.772 V	72	2.284 V	B2	2.796 V	F2	3.308 V
				33	1.780 V	73	2.292 V	B3	2.804 V	F3	3.316 V
				34	1.788 V	74	2.300 V	B4	2.812 V	F4	3.324 V
				35	1.796 V	75	2.308 V	B5	2.820 V	F5	3.332 V
				36	1.804 V	76	2.316 V	B6	2.828 V	F6	3.340 V
				37	1.812 V	77	2.324 V	B7	2.836 V	F7	3.348 V
				38	1.820 V	78	2.332 V	B8	2.844 V	F8	3.356 V
				39	1.828 V	79	2.340 V	B9	2.852 V	F9	3.364 V
				3A	1.836 V	7A	2.348 V	BA	2.860 V	FA	3.372 V
				3B	1.844 V	7B	2.356 V	BB	2.868 V	FB	3.380 V
				3C	1.852 V	7C	2.364 V	BC	2.876 V	FC	3.388 V
				3D	1.860 V	7D	2.372 V	BD	2.884 V	FD	3.396 V
				3E	1.868 V	7E	2.380 V	BE	2.892 V	FE	3.404 V
				3F	1.876 V	7F	2.388 V	BF	2.900 V	FF	3.412 V

FAN53840, FAN53841

Table 10. REGISTER DETAILS – 0X06 CHAN4

0x06 CHAN4				Default = 00000000							
Bit	Name	Default	Type	Description							
7:0	LDO4_VOUT	00000000	R/W	When LDO_LS4_SELECT bit is set to "0", these register bits sets LDO4 regulation target voltage. Equation: $V_{out} = 1.500\text{ V} + [(d - 16) * 8\text{ mV}]$, where d is the decimal value of the register. The Default (00h) points to the OTP programmed default value. If this register is not reprogrammed, a read of the register will return 00h.							
				Hex	VOUT	Hex	VOUT	Hex	VOUT	Hex	VOUT
				00	DEFAULT	40	1.884 V	80	2.396 V	C0	2.908 V
				01	Reserved	41	1.892 V	81	2.404 V	C1	2.916 V
				02	Reserved	42	1.900 V	82	2.412 V	C2	2.924 V
				03	Reserved	43	1.908 V	83	2.420 V	C3	2.932 V
				04	Reserved	44	1.916 V	84	2.428 V	C4	2.940 V
				05	Reserved	45	1.924 V	85	2.436 V	C5	2.948 V
				06	Reserved	46	1.932 V	86	2.444 V	C6	2.956 V
				07	Reserved	47	1.940 V	87	2.452 V	C7	2.964 V
				08	Reserved	48	1.948 V	88	2.460 V	C8	2.972 V
				09	Reserved	49	1.956 V	89	2.468 V	C9	2.980 V
				0A	Reserved	4A	1.964 V	8A	2.476 V	CA	2.988 V
				0B	Reserved	4B	1.972 V	8B	2.484 V	CB	2.996 V
				0C	Reserved	4C	1.980 V	8C	2.492 V	CC	3.004 V
				0D	Reserved	4D	1.988 V	8D	2.500 V	CD	3.012 V
				0E	Reserved	4E	1.996 V	8E	2.508 V	CE	3.020 V
				0F	Reserved	4F	2.004 V	8F	2.516 V	CF	3.028 V
				10	1.500 V	50	2.012 V	90	2.524 V	D0	3.036 V
				11	1.508 V	51	2.020 V	91	2.532 V	D1	3.044 V
				12	1.516 V	52	2.028 V	92	2.540 V	D2	3.052 V
				13	1.524 V	53	2.036 V	93	2.548 V	D3	3.060 V
				14	1.532 V	54	2.044 V	94	2.556 V	D4	3.068 V
				15	1.540 V	55	2.052 V	95	2.564 V	D5	3.076 V
				16	1.548 V	56	2.060 V	96	2.572 V	D6	3.084 V
				17	1.556 V	57	2.068 V	97	2.580 V	D7	3.092 V
				18	1.564 V	58	2.076 V	98	2.588 V	D8	3.100 V
				19	1.572 V	59	2.084 V	99	2.596 V	D9	3.108 V
				1A	1.580 V	5A	2.092 V	9A	2.604 V	DA	3.116 V
				1B	1.588 V	5B	2.100 V	9B	2.612 V	DB	3.124 V
				1C	1.596 V	5C	2.108 V	9C	2.620 V	DC	3.132 V
				1D	1.604 V	5D	2.116 V	9D	2.628 V	DD	3.140 V
				1E	1.612 V	5E	2.124 V	9E	2.636 V	DE	3.148 V
				1F	1.620 V	5F	2.132 V	9F	2.644 V	DF	3.156 V
				20	1.628 V	60	2.140 V	A0	2.652 V	E0	3.164 V
				21	1.636 V	61	2.148 V	A1	2.660 V	E1	3.172 V
				22	1.644 V	62	2.156 V	A2	2.668 V	E2	3.180 V
				23	1.652 V	63	2.164 V	A3	2.676 V	E3	3.188 V
				24	1.660 V	64	2.172 V	A4	2.684 V	E4	3.196 V
				25	1.668 V	65	2.180 V	A5	2.692 V	E5	3.204 V

FAN53840, FAN53841

Table 10. REGISTER DETAILS – 0X06 CHAN4 (continued)

0x06 CHAN4				Default = 0000000							
Bit	Name	Default	Type	Description							
				26	1.676 V	66	2.188 V	A6	2.700 V	E6	3.212 V
				27	1.684 V	67	2.196 V	A7	2.708 V	E7	3.220 V
				28	1.692 V	68	2.204 V	A8	2.716 V	E8	3.228 V
				29	1.700 V	69	2.212 V	A9	2.724 V	E9	3.236 V
				2A	1.708 V	6A	2.220 V	AA	2.732 V	EA	3.244 V
				2B	1.716 V	6B	2.228 V	AB	2.740 V	EB	3.252 V
				2C	1.724 V	6C	2.236 V	AC	2.748 V	EC	3.260 V
				2D	1.732 V	6D	2.244 V	AD	2.756 V	ED	3.268 V
				2E	1.740 V	6E	2.252 V	AE	2.764 V	EE	3.276 V
				2F	1.748 V	6F	2.260 V	AF	2.772 V	EF	3.284 V
				30	1.756 V	70	2.268 V	B0	2.780 V	F0	3.292 V
				31	1.764 V	71	2.276 V	B1	2.788 V	F1	3.300 V
				32	1.772 V	72	2.284 V	B2	2.796 V	F2	3.308 V
				33	1.780 V	73	2.292 V	B3	2.804 V	F3	3.316 V
				34	1.788 V	74	2.300 V	B4	2.812 V	F4	3.324 V
				35	1.796 V	75	2.308 V	B5	2.820 V	F5	3.332 V
				36	1.804 V	76	2.316 V	B6	2.828 V	F6	3.340 V
				37	1.812 V	77	2.324 V	B7	2.836 V	F7	3.348 V
				38	1.820 V	78	2.332 V	B8	2.844 V	F8	3.356 V
				39	1.828 V	79	2.340 V	B9	2.852 V	F9	3.364 V
				3A	1.836 V	7A	2.348 V	BA	2.860 V	FA	3.372 V
				3B	1.844 V	7B	2.356 V	BB	2.868 V	FB	3.380 V
				3C	1.852 V	7C	2.364 V	BC	2.876 V	FC	3.388 V
				3D	1.860 V	7D	2.372 V	BD	2.884 V	FD	3.396 V
				3E	1.868 V	7E	2.380 V	BE	2.892 V	FE	3.404 V
				3F	1.876 V	7F	2.388 V	BF	2.900 V	FF	3.412 V

FAN53840, FAN53841

Table 11. REGISTER DETAILS – 0X07 RESET

0X07 RESET				Default = 0000110	
Bit	Name	Default	Type	Description	
7:4	SOFT_RESET	0000	Write	Code	Software Reset
				1011	Writing a “1011” begins a soft reset of the device I ² C registers to their default values. These bits are cleared upon execution of the Reset function.
					Any other value than “1011” will be ignored.
3	UNUSED	0	Read		
2:1	OCP_TIMER	11	R/W	Option bits to control the length of the deglitch timer for current limit on all LDOs before a fault is triggered.	
				Code	Deglitch Timer
				00	125 μ s
				01	250 μ s
				10	500 μ s
11	1 ms				
0	FLT_SD_B	0	R/W	Code	Prevents Shutdown When a Fault Occurs
				0	LDO is shutdown if a OCP event occurs or if the LDO's input VIN1, VIN2, VIN3, or VIN4 have a UVLO event.
				1	LDO is not shutdown if a OCP event occurs. If the LDO's input VIN1, VIN2, VIN3, or VIN4 have a UVLO event, the associated LDO will be shutdown until the supply returns, but the fault will not be counted.
				Note: If this bit function is desired, FLT_SD_B should be set to “1” prior to enabling any LDOs after a Power-On-Reset.	

FAN53840, FAN53841

Table 12. REGISTER DETAILS – 0x08 LDO_COMP0

0x08 LDO_COMP0				Default = 0000001		
Bit	Name	Default	Type	Description		
7:6	LDO4_COMP_SEL	00	R/W	The LDO4 Compensation is selected by modifying these bits to account for different COUT values. The Cout_min and Cout_max values are nominal 0DCV bias capacitance values utilized with the following DC de-rating:		
				Code	Cout_min	Cout_max
				00	1.0 μ F	< 4.7 μ F
				01	4.7 μ F	< 15 μ F
				10	15 μ F	< 47 μ F
11	NA	NA				
5:4	LDO3_COMP_SEL	00	R/W	The LDO3 Compensation is selected by modifying these bits to account for different COUT value. The Cout_min and Cout_max values are nominal 0DCV bias capacitance values utilized with the following DC de-rating:		
				Code	Cout_min	Cout_max
				00	1.0 μ F	< 4.7 μ F
				01	4.7 μ F	< 15 μ F
				10	15 μ F	< 47 μ F
11	NA	NA				
3:2	LDO2_COMP_SEL	00	R/W	The LDO2 Compensation is selected by modifying these bits to account for different COUT value.		
				Code	Cout_min	Cout_max
				00	1.0 μ F	< 4.7 μ F
				01	4.7 μ F	< 15 μ F
				10	15 μ F	< 47 μ F
11	NA	NA				
1:0	LDO1_COMP_SEL	01	R/W	The LDO1 Compensation is selected by modifying these bits to account for different COUT value.		
				Code	Cout_min	Cout_max
				00	–	< 5.5 μ F
				01	5.5 μ F	17 μ F
				10	17 μ F	34 μ F
11	–	> 34 μ F				

Table 13. REGISTER DETAILS – 0X09 INTERRUPT1

0X09 INTERRUPT1				Default = 00000000	
Bit	Name	Default	Type	Description	
7	UNUSED	0	Read		
6	UNUSED	0	Read		
5	UNUSED	0	Read		
4	UNUSED	0	Read		
3	LDO4_OCP_INT	0	R/CLR	Code	LDO4 OCP Interrupt
				0	Clear
				1	Over-Current event detected on LDO4 output or that a successful restart has occurred after an OCP event.
2	LDO3_OCP_INT	0	R/CLR	Code	LDO3 OCP Interrupt
				0	Clear
				1	Over-Current event detected on LDO3 output or that a successful restart has occurred after an OCP event.
1	LDO2_OCP_INT	0	R/CLR	Code	LDO2 OCP Interrupt
				0	Clear
				1	Over-Current event detected on LDO2 output or that a successful restart has occurred after an OCP event.
0	LDO1_OCP_INT	0	R/CLR	Code	LDO1 OCP Interrupt
				0	Clear
				1	Over-Current event detected on LDO1 output or that a successful restart has occurred after an OCP event.

Table 14. REGISTER DETAILS – 0X0A INTERRUPT2

0X0A INTERRUPT2				Default = 00000000	
Bit	Name	Default	Type	Description	
7	UNUSED	0	Read		
6	TSD_INT	0	R/CLR	Code	Thermal Shutdown Interrupt
				0	Clear
				1	A Thermal Shutdown event detected or that the temperature has fallen below the hysteresis level.
5	TSD_WRN_INT	0	R/CLR	Code	Thermal Warning Interrupt
				0	Clear
				1	Thermal Shutdown Warning threshold was surpassed or that the temperature has fallen below the hysteresis level.
4	VSYS_UVLO_INT	0	R/CLR	Code	VSYS Under-Voltage-Lock-Out Interrupt
				0	Normal operation
				1	Indicates that the VSYS power fell below the UVLO input threshold or that the supplies have risen above the rising thresholds after a UVLO fault.
				Reading the the associated status bit provides present state of the input voltage.	

FAN53840, FAN53841

Table 14. REGISTER DETAILS – 0X0A INTERRUPT2 (continued)

0X0A INTERRUPT2				Default = 00000000	
Bit	Name	Default	Type	Description	
3	CHAN4_UVLO_INT	0	R/CLR	Code	VIN4 Under-Voltage-Lock-Out Interrupt
				0	Normal Operation
				1	Indicates VIN4 fell below the UVLO threshold while CHAN4 was enabled or that the supply has risen above the rising thresholds after a UVLO fault.
					Reading the associated status bit provides present state of the input voltage.
2	CHAN3_UVLO_INT	0	R/CLR	Code	VIN3 Under-Voltage-Lock-Out Interrupt
				0	Normal Operation
				1	Indicates VIN3 fell below the UVLO threshold while CHAN3 was enabled or that the supply has risen above the rising thresholds after a UVLO fault.
					Reading the associated status bit provides present state of the input voltage.
1	CHAN2_UVLO_INT	0	R/CLR	Code	VIN2 Under-Voltage-Lock-Out Interrupt
				0	Normal Operation
				1	Indicates that the VIN2 fell below the UVLO threshold while CHAN2 was enabled or that the supply has risen above the rising thresholds after a UVLO fault.
					Reading the associated status bit provides present state of the input voltage.
0	CHAN1_UVLO_INT	0	R/CLR	Code	VIN1 Under-Voltage-Lock-Out Interrupt
				0	Normal operation
				1	Indicates VIN1 fell below the UVLO threshold while CHAN1 is enabled or that the supply has risen above the rising thresholds after a UVLO fault.
					Reading the associated status bit provides present state of the input voltage.

FAN53840, FAN53841

Table 15. REGISTER DETAILS – 0X0B STATUS1

0X0B STATUS1				Default = 00000000	
Bit	Name	Default	Type	Description	
7	UNUSED	0	Read		
6	UNUSED	0	Read		
5	UNUSED	0	Read		
4	UNUSED	0	Read		
3	LDO4_OCP_STAT	0	Read	Code	LDO4 OCP Status
				0	Clear
				1	An Over-Current condition exists on LDO4 output
2	LDO3_OCP_STAT	0	Read	Code	LDO3 OCP Status
				0	Clear
				1	An Over-Current condition exists on LDO3 output
1	LDO2_OCP_STAT	0	Read	Code	LDO2 OCP Status
				0	Clear
				1	An Over-Current condition exists on LDO2 output
0	LDO1_OCP_STAT	0	Read	Code	LDO1 OCP Status
				0	Clear
				1	An Over-Current condition exists on LDO1 output

Table 16. REGISTER DETAILS – 0X0C STATUS2

0X0C STATUS2				Default = 00000000	
Bit	Name	Default	Type	Description	
7	UNUSED	0	Read		
6	TSD_STAT	0	Read	Code	Temperature Shutdown Status
				0	Normal Operation
				1	Device is in Thermal Shutdown
5	TSD_WRN_STAT	0	Read	Code	Temperature Warning Status
				0	Normal Operation
				1	The temperature is above the thermal warning level and shutdown is impending.
4	VSYS_UVLO_STAT	0	Read	Code	VSYS Under-Voltage-Lock-Out Status
				0	Normal Operation
				1	VSYS is below the UVLO threshold.
3	CHAN4_UVLO_STAT	0	Read	Code	VIN4 Under-Voltage-Lock-Out Status
				0	Normal Operation
				1	Indicates VIN4 is below the UVLO threshold while LDO4 is enabled.
2	CHAN3_UVLO_STAT	0	Read	Code	VIN3 Under-Voltage-Lock-Out Status
				0	Normal Operation
				1	Indicates VIN3 is below the UVLO threshold while LDO3 is enabled.

FAN53840, FAN53841

Table 16. REGISTER DETAILS – 0X0C STATUS2 (continued)

0X0C STATUS2				Default = 00000000	
Bit	Name	Default	Type	Description	
1	CHAN2_UVLO_STAT	0	Read	Code	VIN2 Under-Voltage-Lock-Out Status
				0	Normal Operation
				1	Indicates VIN2 power rail is below the UVLO threshold while LDO2 is enabled.
0	CHAN1_UVLO_STAT	0	Read	Code	VIN1 Under-Voltage-Lock-Out Status
				0	Normal Operation
				1	Indicates VIN1 is below the UVLO threshold while LDO1 is enabled.

Table 17. REGISTER DETAILS – 0X0D STATUS3

0X0D STATUS3				Default = 00000000	
Bit	Name	Default	Type	Description	
7	UNUSED	0	Read		
6	UNUSED	0	Read		
5	UNUSED	0	Read		
4	CHIP_SUSP	0	Read	Code	Chip Suspension
				0	Chip normal state
				1	The entire chip has been suspended due to a global fault condition.
3	CHAN4_SUSP	0	Read	Code	CHAN4 Output Suspended
				0	CHAN4 in normal state.
				1	CHAN4 has been suspended due to a fault condition.
2	CHAN3_SUSP	0	Read	Code	CHAN3 Output Suspended
				0	CHAN3 in a normal state
				1	CHAN3 has been suspended due to a fault condition.
1	CHAN2_SUSP	0	Read	Code	CHAN2 Output Suspended
				0	CHAN2 in normal state
				1	CHAN2 has been suspended due to a fault condition.
0	CHAN1_SUSP	0	Read	Code	CHAN1 Output Suspended
				0	CHAN1 is in normal state
				1	CHAN1 has been suspended due to a fault condition.

FAN53840, FAN53841

Table 18. REGISTER DETAILS – 0X0E MINT1

0X0E MINT1				Default = 00000000	
Bit	Name	Default	Type	Description	
7	UNUSED	0	Read		
6	UNUSED	0	Read		
5	UNUSED	0	Read		
4	UNUSED	0	Read		
3	MASK_LDO4_OCP	0	R/W	Code	LDO4 OCP MASK
				0	No masking of interrupt.
				1	INT(B) pin will not change states when LDO4 Over-Current interrupt occurs.
2	MASK_LDO3_OCP	0	R/W	Code	LDO3 OCP MASK
				0	No masking of interrupt.
				1	INT(B) pin will not change states when LDO3 Over-Current interrupt occurs.
1	MASK_LDO2_OCP	0	R/W	Code	LDO2 OCP MASK
				0	No masking of interrupt.
				1	INT(B) pin will not change states when LDO2 Over-Current interrupt occurs.
0	MASK_LDO1_OCP	0	R/W	Code	LDO1 OCP MASK
				0	No masking of interrupt.
				1	INT(B) pin will not change states when LDO1 Over-Current interrupt occurs.

Table 19. REGISTER DETAILS – 0X0F MINT2

0X0F MINT2				Default = 00000000	
Bit	Name	Default	Type	Description	
7	UNUSED	0	Read		
6	MASK_TSD	0	R/W	Code	Thermal Shutdown MASK
				0	No masking of interrupt.
				1	INT(B) pin will not change states when a Thermal Shutdown interrupt occurs.
5	MASK_TSD_WRN	0	R/W	Code	Thermal Warning MASK
				0	No masking of interrupt.
				1	INT(B) pin will not change states when LDO7 Over-Current interrupt occurs.
4	MASK_VSYS_UVLO	0	R/W	Code	VSYS UVLO MASK
				0	No masking of interrupt.
				1	INT(B) pin will not change states when VSYS Input Power Under Voltage interrupt occurs.
3	MASK_CHAN4_UVLO	0	R/W	Code	VIN4 UVLO MASK
				0	No masking of interrupt.
				1	INT(B) pin will not change states when VIN4 Input Power Under Voltage interrupt occurs

FAN53840, FAN53841

Table 19. REGISTER DETAILS – 0X0F MINT2 (continued)

0X0F MINT2				Default = 00000000	
Bit	Name	Default	Type	Description	
2	MASK_CHAN3_UVLO	0	R/W	Code	VIN3 UVLO MASK
				0	No masking of interrupt.
				1	INT(B) pin will not change states when VIN3 Input Power Under Voltage interrupt occurs.
1	MASK_CHAN2_UVLO	0	R/W	Code	VIN2 UVLO MASK
				0	No masking of interrupt.
				1	INT(B) pin will not change states when VIN2 Input Power Under Voltage interrupt occurs.
0	MASK_CHAN1_UVLO	0	R/W	Code	VIN1 UVLO MASK
				0	No masking of interrupt.
				1	INT(B) pin will not change states when VIN1 Input Power Under Voltage interrupt occurs.

Table 20. REGISTER DETAILS – 0X10 LDO_LS_SELECT

0X10 LDO_LS_SELECT				Default = 00000000	
Bit	Name	Default	Type	Description	
7	UNUSED	0	Read		
6	UNUSED	0	Read		
5	UNUSED	0	Read		
4	UNUSED	0	Read		
3	LDO_LS4_SELECT	0	R/W	Configuration of Output 4	
				Code	Configuration
				0	Configured to operate as an LDO
				1	Configured to operate as a Load Switch
2	LDO_LS3_SELECT	0	R/W	Configuration of Output 3	
				Code	Configuration
				0	Configured to operate as an LDO
				1	Configured to operate as a Load Switch
1	LDO_LS2_SELECT	0	R/W	Configuration of Output 2	
				Code	Configuration
				0	Configured to operate as an LDO
				1	Configured to operate as a Load Switch
0	LDO_LS1_SELECT	0	R/W	Configuration of Output 1	
				Code	Configuration
				0	Configured to operate as an LDO
				1	Configured to operate as a Load Switch

APPLICATION GUIDELINES

LDO Input Capacitor Considerations

If long wires are used to bring power to an evaluation board, additional “bulk” capacitance should be placed on the evaluation board between the local input capacitor(s) and the power source lead(s) to reduce ringing caused by inductance lead length. Use only X5R and X7R ceramic capacitors with adequate voltage rating for local input capacitors.

The effective capacitance value decreases as the voltage across the capacitor increases due to DC bias effects. Adding additional capacitance to the minimum recommended ensures reliable operation.

LDO Output Capacitor Considerations

FAN53840 LDOs are initially set at the factory for a range of 4.7 μ F to 10 μ F (unbiased) on LDO1. LDO2/3/4 are initially set for a range of 1 μ F to 4.7 μ F (unbiased). All LDOs can be trimmed at the factory for up to 47 μ F total (unbiased) capacitance. When evaluating and ordering the

FAN53840, to ensure optimum performance and stability, specify the amount of capacitance each LDO output will have with an **onsemi** representative.

Use only X5R and X7R ceramic capacitors with adequate voltage rating for the output capacitors.

PCB Layout Recommendations

Local input and output capacitors should be placed close to the corresponding input and output pins. The ground terminal of the capacitors should be connected to a good ground plane – preferably on the surface of the board. Input power should be routed to the input capacitor first, then to the input pin(s) of the IC. Power from layers other than the layer on which a capacitor sits, should be routed to the capacitor layer with vias close to the positive terminal of the capacitor. Power traces from outputs should be routed to the output capacitor first, then to other layers if necessary.

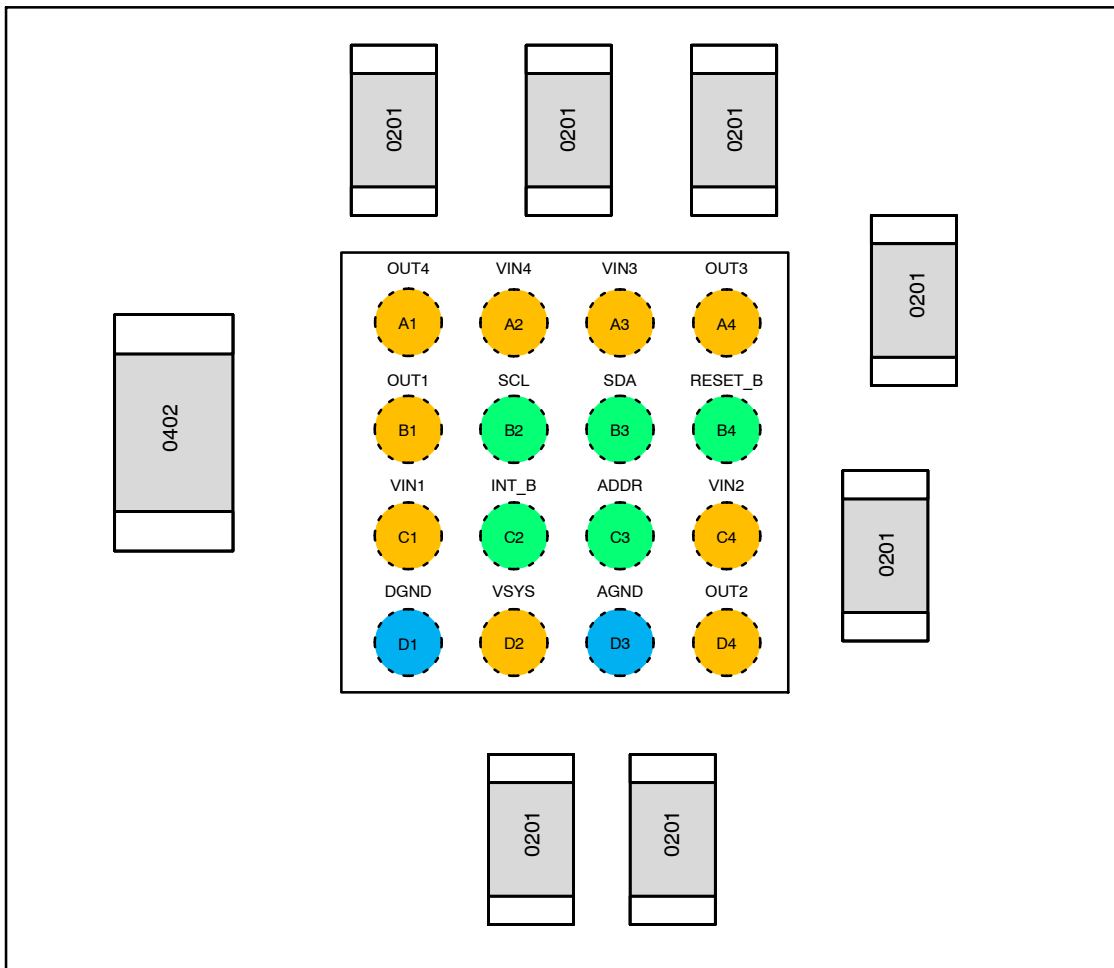

Figure 31. Recommended PCB Assembly (Top View)

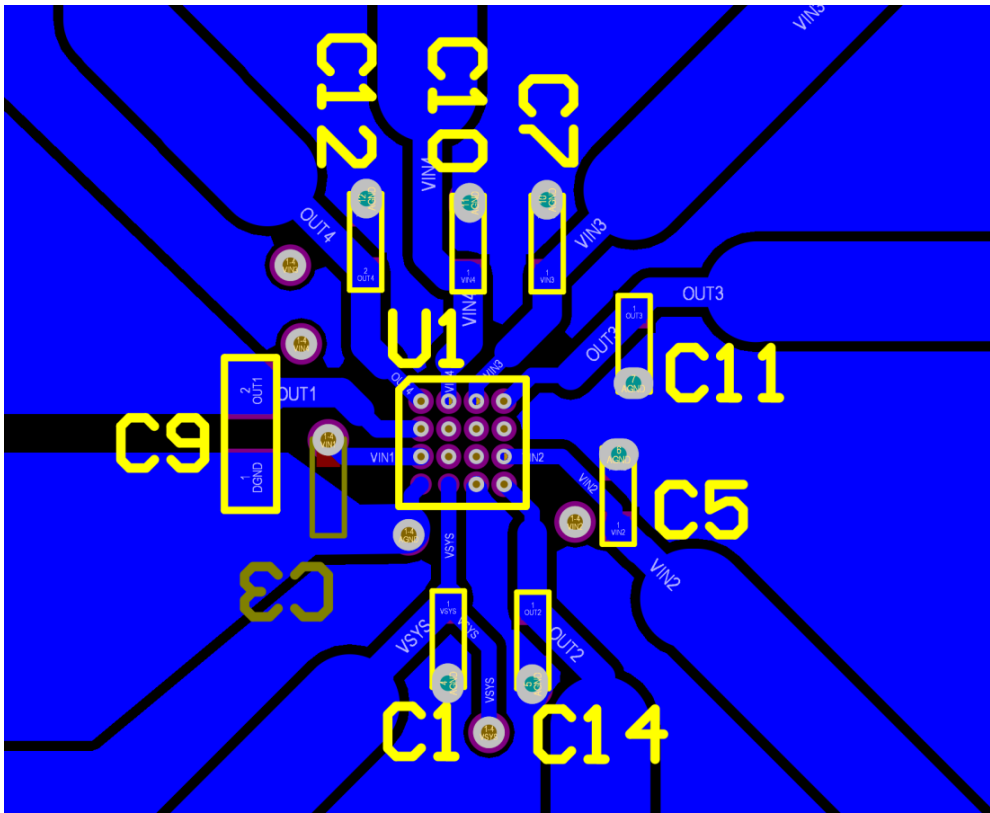

Figure 32. Recommended PCB Layout

MECHANICAL CASE OUTLINE

PACKAGE DIMENSIONS

ON Semiconductor®



WLCSP16 1.52x1.52x0.432
CASE 567ZM
ISSUE O

DATE 14 SEP 2020

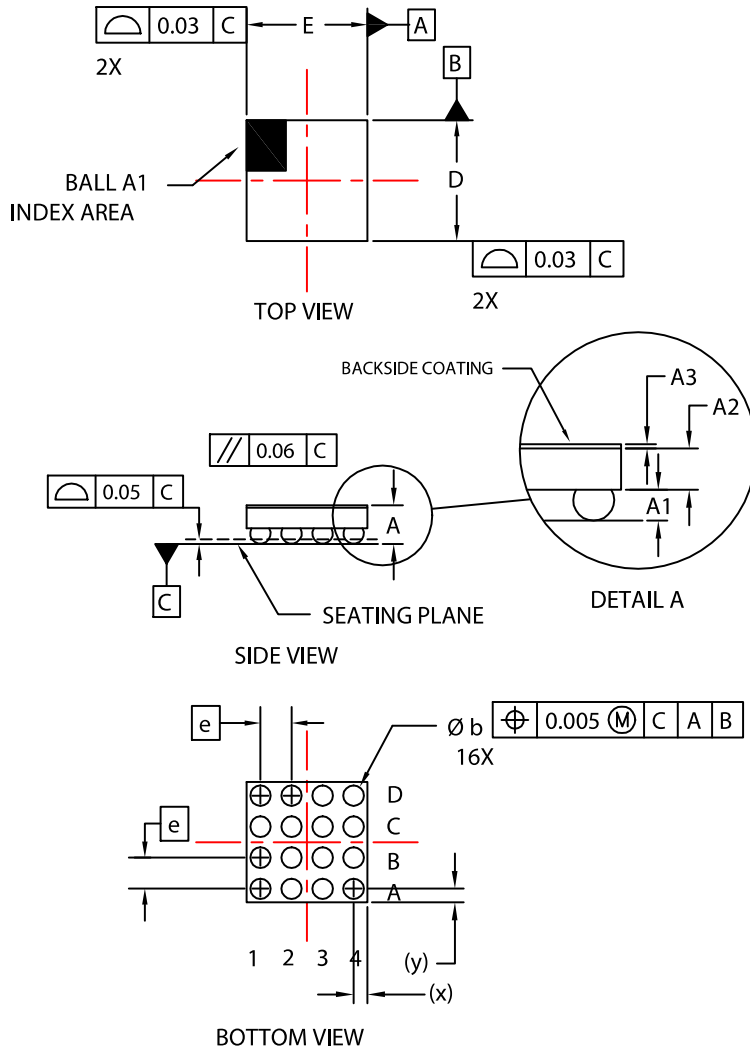

NOTES:

1. DIMENSIONING AND TOLERANCING PER ASME Y14.5M, 2009.
2. CONTROLLING DIMENSION: MILLIMETERS
3. DATUM C IS DEFINED BY THE SPHERICAL CROWNS OF THE SOLDER BALLS

DIM	MILLIMETERS		
	MIN.	NOM.	MAX.
A	0.391	0.432	0.473
A1	0.154	0.174	0.194
A2	0.215	0.233	0.251
A3	0.022	0.025	0.028
b	0.211	0.231	0.251
D	1.49	1.52	1.55
E	1.49	1.52	1.55
e	0.35 BSC		
x	0.220	0.235	0.250
y	0.220	0.235	0.250

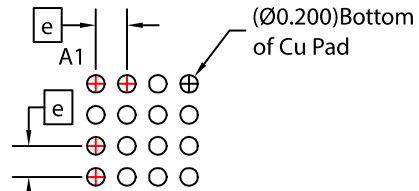

RECOMMENDED MOUNTING FOOTPRINT* (NSMD PAD TYPE)

*FOR ADDITIONAL INFORMATION ON OUR Pb-FREE STRATEGY AND SOLDERING DETAILS, PLEASE DOWNLOAD THE ON SEMICONDUCTOR SOLDERING AND MOUNTING TECHNIQUES REFERENCE MANUAL, SOLDERRM/D.

DOCUMENT NUMBER:	98AON22197H	Electronic versions are uncontrolled except when accessed directly from the Document Repository. Printed versions are uncontrolled except when stamped "CONTROLLED COPY" in red.
DESCRIPTION:	WLCSP16 1.52x1.52x0.432	PAGE 1 OF 1

ON Semiconductor and ON are trademarks of Semiconductor Components Industries, LLC dba ON Semiconductor or its subsidiaries in the United States and/or other countries. ON Semiconductor reserves the right to make changes without further notice to any products herein. ON Semiconductor makes no warranty, representation or guarantee regarding the suitability of its products for any particular purpose, nor does ON Semiconductor assume any liability arising out of the application or use of any product or circuit, and specifically disclaims any and all liability, including without limitation special, consequential or incidental damages. ON Semiconductor does not convey any license under its patent rights nor the rights of others.

onsemi, **Onsemi**, and other names, marks, and brands are registered and/or common law trademarks of Semiconductor Components Industries, LLC dba "**onsemi**" or its affiliates and/or subsidiaries in the United States and/or other countries. **onsemi** owns the rights to a number of patents, trademarks, copyrights, trade secrets, and other intellectual property. A listing of **onsemi**'s product/patent coverage may be accessed at www.onsemi.com/site/pdf/Patent-Marking.pdf. **onsemi** reserves the right to make changes at any time to any products or information herein, without notice. The information herein is provided "as-is" and **onsemi** makes no warranty, representation or guarantee regarding the accuracy of the information, product features, availability, functionality, or suitability of its products for any particular purpose, nor does **onsemi** assume any liability arising out of the application or use of any product or circuit, and specifically disclaims any and all liability, including without limitation special, consequential or incidental damages. Buyer is responsible for its products and applications using **onsemi** products, including compliance with all laws, regulations and safety requirements or standards, regardless of any support or applications information provided by **onsemi**. "Typical" parameters which may be provided in **onsemi** data sheets and/or specifications can and do vary in different applications and actual performance may vary over time. All operating parameters, including "Typicals" must be validated for each customer application by customer's technical experts. **onsemi** does not convey any license under any of its intellectual property rights nor the rights of others. **onsemi** products are not designed, intended, or authorized for use as a critical component in life support systems or any FDA Class 3 medical devices or medical devices with a same or similar classification in a foreign jurisdiction or any devices intended for implantation in the human body. Should Buyer purchase or use **onsemi** products for any such unintended or unauthorized application, Buyer shall indemnify and hold **onsemi** and its officers, employees, subsidiaries, affiliates, and distributors harmless against all claims, costs, damages, and expenses, and reasonable attorney fees arising out of, directly or indirectly, any claim of personal injury or death associated with such unintended or unauthorized use, even if such claim alleges that **onsemi** was negligent regarding the design or manufacture of the part. **onsemi** is an Equal Opportunity/Affirmative Action Employer. This literature is subject to all applicable copyright laws and is not for resale in any manner.

PUBLICATION ORDERING INFORMATION

LITERATURE FULFILLMENT:

Email Requests to: orderlit@onsemi.com

onsemi Website: www.onsemi.com

TECHNICAL SUPPORT

North American Technical Support:

Voice Mail: 1 800-282-9855 Toll Free USA/Canada

Phone: 011 421 33 790 2910

Europe, Middle East and Africa Technical Support:

Phone: 00421 33 790 2910

For additional information, please contact your local Sales Representative