

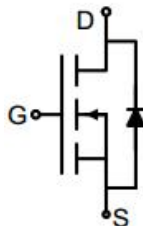

N-Channel Enhancement Mode Power MOSFET

<p>Description</p> <p>The GC20N65Q uses advanced trench technology to provide excellent $R_{DS(ON)}$, low gate charge. It can be used in a wide variety of applications.</p> <p>General Features</p> <ul style="list-style-type: none"> ● V_{DS} 650V ● I_D (at $V_{GS} = 10V$) 20A ● $R_{DS(ON)}$ (at $V_{GS} = 10V$) < 170mΩ ● 100% Avalanche Tested ● RoHS Compliant <p>Application</p> <ul style="list-style-type: none"> ● Power switch ● DC/DC converters 	 <p>Schematic diagram</p>  <p>TO-247</p>
--	--

Ordering Information

Device	Package	Marking	Packaging
GC20N65Q	TO-247	GC20N65	50psc/Tube

Absolute Maximum Ratings $T_C = 25^\circ C$, unless otherwise noted

Parameter	Symbol	Value	Unit
Drain-Source Voltage	V_{DS}	650	V
Continuous Drain Current	I_D	20	A
Pulsed Drain Current (note1)	I_{DM}	60	A
Gate-Source Voltage	V_{GS}	± 30	V
Power Dissipation	P_D	151	W
Single pulse avalanche energy (note2)	E_{AS}	484	mJ
Operating Junction and Storage Temperature Range	T_J, T_{stg}	-55 To 150	$^\circ C$

Thermal Resistance

Parameter	Symbol	Value	Unit
Thermal Resistance, Junction-to-Ambient	R_{thJA}	62	$^\circ C/W$
Maximum Junction-to-Case	R_{thJC}	0.83	$^\circ C/W$

Specifications $T_J = 25^\circ\text{C}$, unless otherwise noted						
Parameter	Symbol	Test Conditions	Value			Unit
			Min.	Typ.	Max.	
Static Parameters						
Drain-Source Breakdown Voltage	$V_{(BR)DSS}$	$V_{GS} = 0V, I_D = 250\mu A$	650	--	--	V
Zero Gate Voltage Drain Current	I_{DSS}	$V_{DS} = 650V, V_{GS} = 0V$	--	--	1	μA
Gate-Source Leakage	I_{GSS}	$V_{GS} = \pm 30V$	--	--	± 100	nA
Gate-Source Threshold Voltage	$V_{GS(th)}$	$V_{DS} = V_{GS}, I_D = 250\mu A$	2.5	--	4.5	V
Drain-Source On-Resistance	$R_{DS(on)}$	$V_{GS} = 10V, I_D = 10A$	--	150	170	m Ω
Dynamic Parameters						
Input Capacitance	C_{iss}	$V_{GS} = 0V,$ $V_{DS} = 100V,$ $f = 1.0\text{MHz}$	--	1724	--	pF
Output Capacitance	C_{oss}		--	61	--	
Reverse Transfer Capacitance	C_{rss}		--	6	--	
Total Gate Charge	Q_g	$V_{DD} = 520V,$ $I_D = 20A,$ $V_{GS} = 10V$	--	39	--	nC
Gate-Source Charge	Q_{gs}		--	8	--	
Gate-Drain Charge	Q_{gd}		--	15	--	
Turn-on Delay Time	$t_{d(on)}$	$V_{DD} = 400V,$ $I_D = 20A,$ $R_G = 25\Omega$	--	15	--	ns
Turn-on Rise Time	t_r		--	59	--	
Turn-off Delay Time	$t_{d(off)}$		--	121	--	
Turn-off Fall Time	t_f		--	44	--	
Drain-Source Body Diode Characteristics						
Continuous Body Diode Current	I_S	$T_C = 25^\circ\text{C}$	--	--	20	A
Body Diode Voltage	V_{SD}	$T_J = 25^\circ\text{C}, I_{SD} = 10A, V_{GS} = 0V$	--	--	1.2	V
Reverse Recovery Charge	Q_{rr}	$I_F = 20A, V_{GS} = 0V$ $di/dt = 100A/\mu s$	--	5.3	--	nC
Reverse Recovery Time	T_{rr}		--	423	--	ns

Notes

1. Repetitive Rating: Pulse width limited by maximum junction temperature
2. EAS condition : $T_J = 25^\circ\text{C}, V_{DD} = 50V, V_{GS} = 10V, L = 0.5\text{mH}, R_G = 25\Omega$
3. Identical low side and high side switch with identical R_G

Gate Charge Test Circuit



Switch Time Test Circuit



EAS Test Circuit



Typical Characteristics $T_J = 25^\circ\text{C}$, unless otherwise noted

Figure 1. Output Characteristics

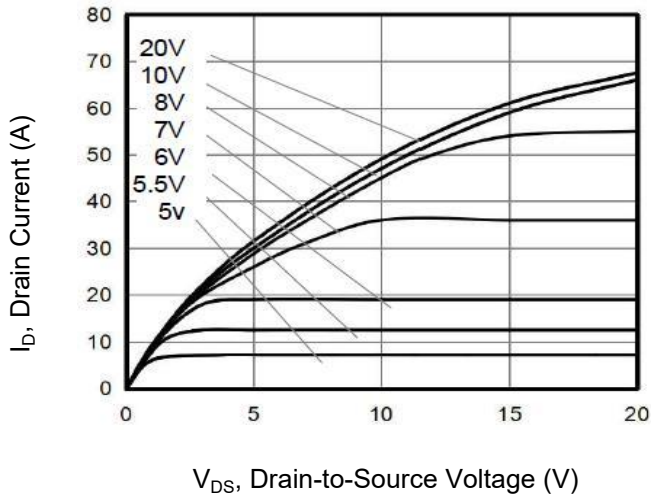

Figure 2. Transfer Characteristics

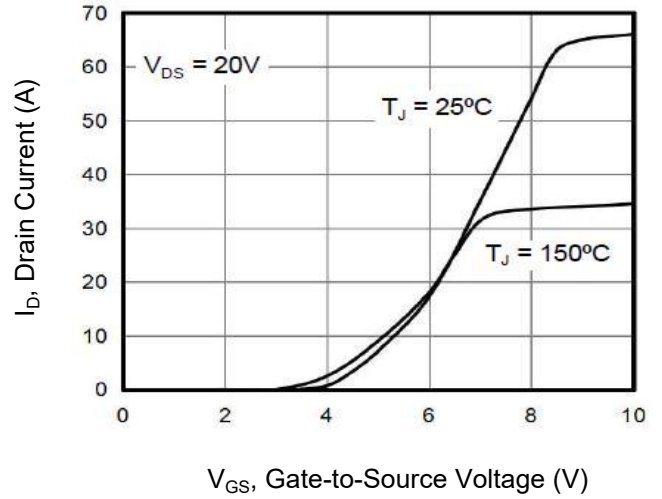

Figure 3. Drain Source On Resistance

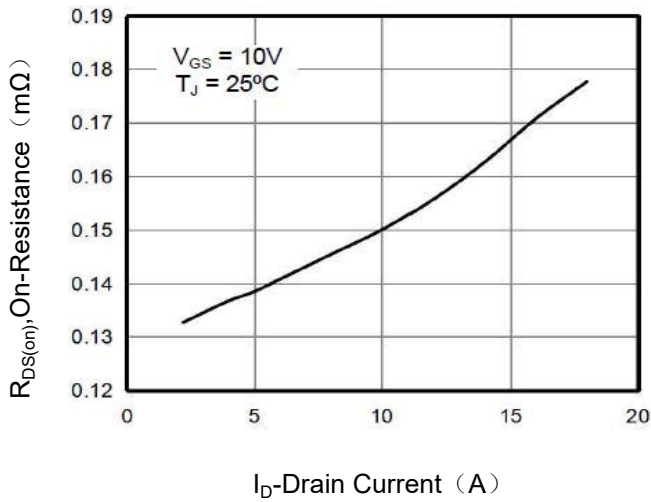

Figure 4. Gate Charge

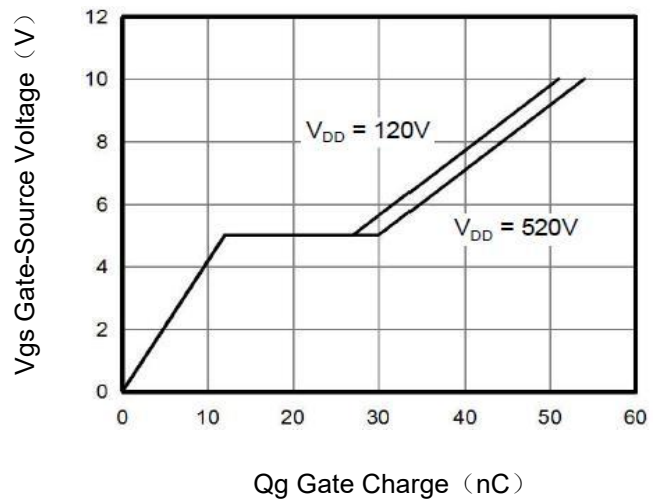

Figure 5. Capacitance

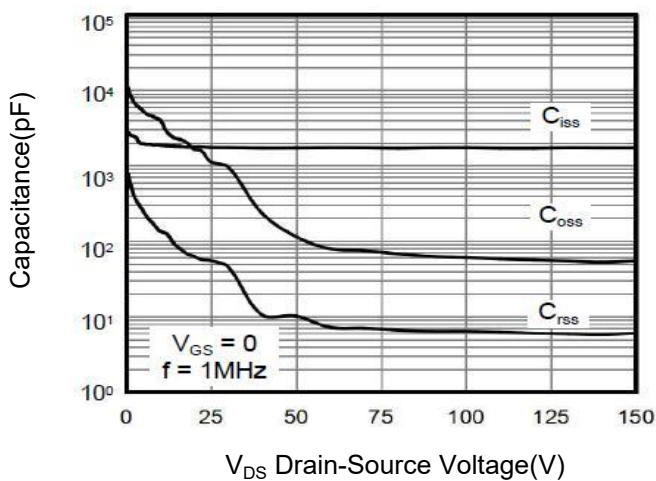
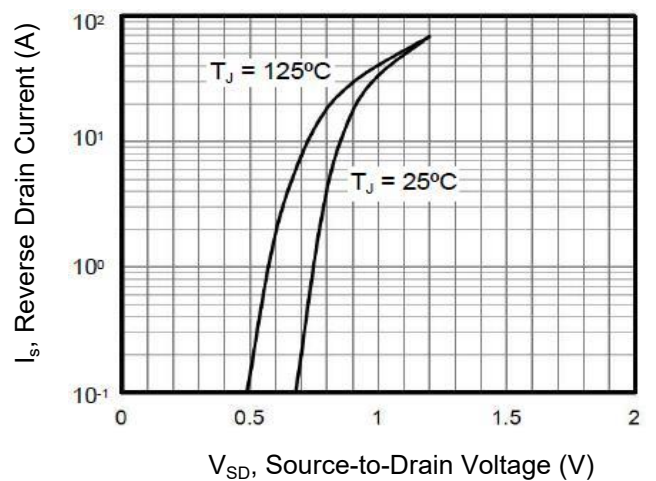

Figure 6. Source-Drain Diode Forward



Typical Characteristics $T_J = 25^\circ\text{C}$, unless otherwise noted

Figure 7. Drain-Source On-Resistance

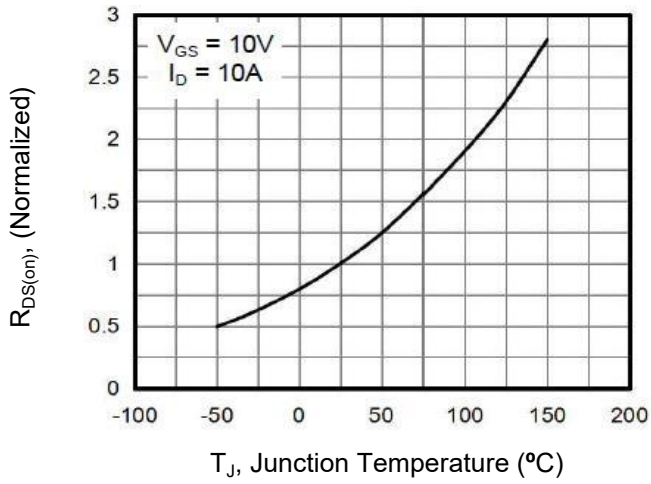

Figure 8. Safe Operation Area

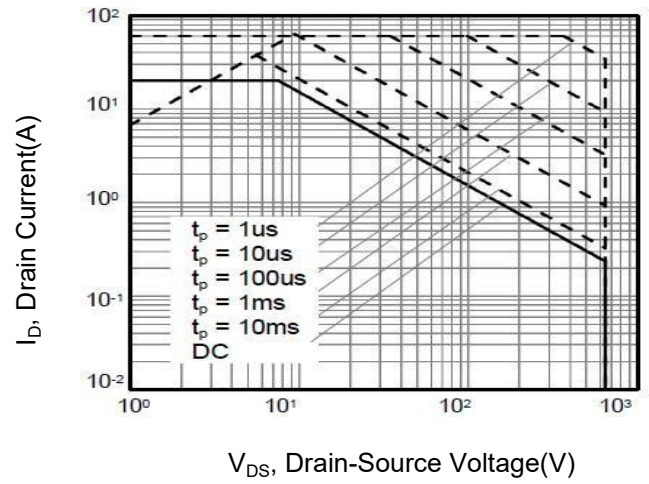
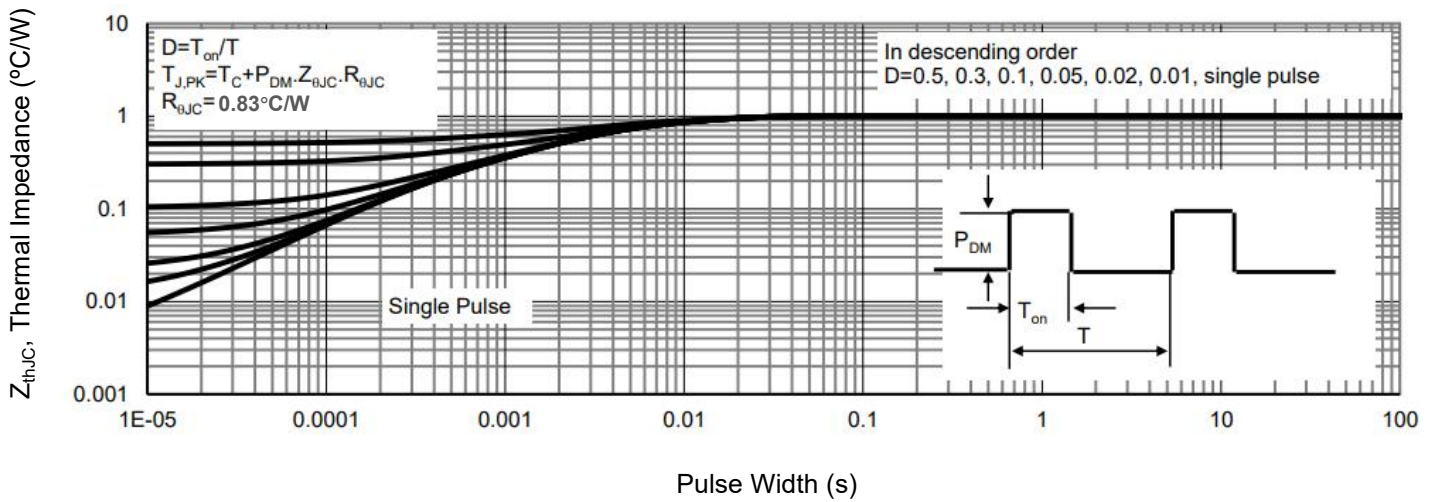
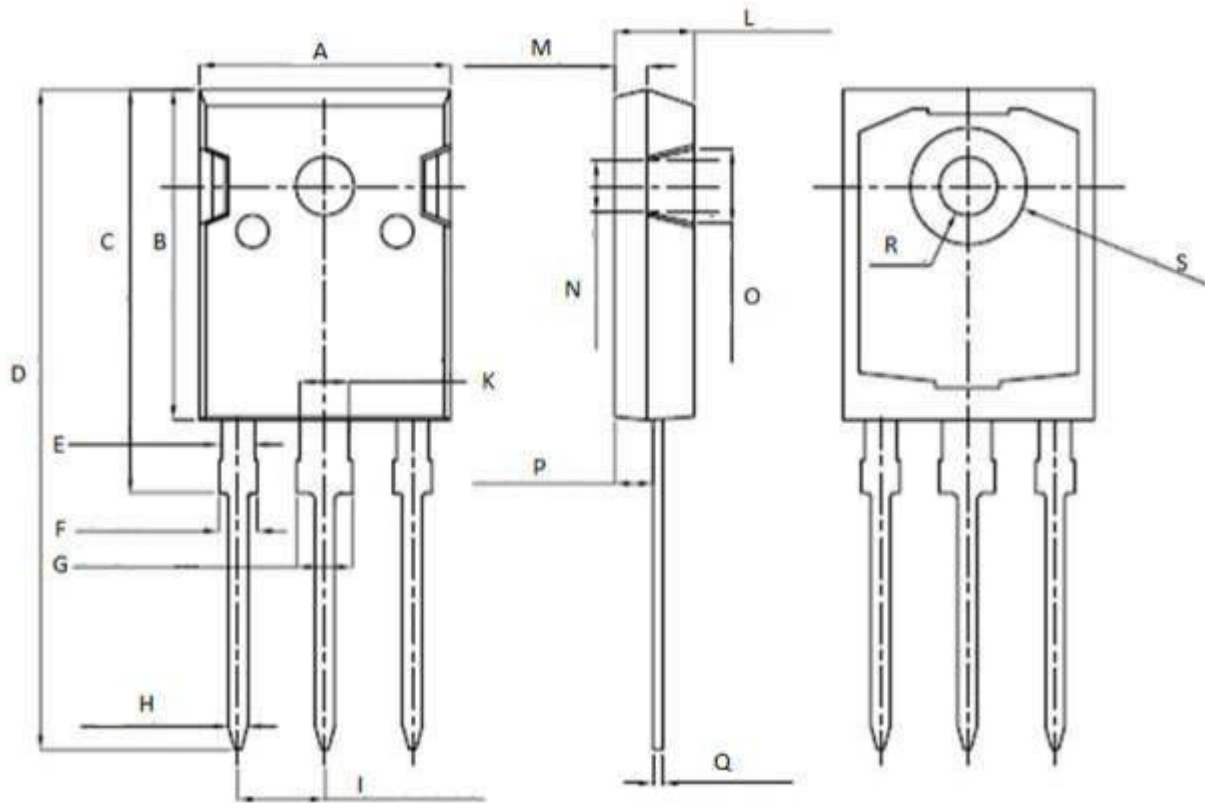

Figure 9. Normalized Maximum Transient Thermal Impedance



TO-247 Package Information



Unit: mm		
Symbol	Min.	Max.
A	15.95	16.25
B	20.85	21.25
C	20.95	21.35
D	40.5	40.9
E	1.9	2.1
F	2.1	2.25
G	3.1	3.25
H	1.1	1.3
I	5.40	5.50

Unit: mm		
Symbol	Min.	Max.
K	2.90	3.10
L	4.90	5.30
M	1.90	2.10
N	4.50	4.70
O	5.40	5.60
P	2.29	2.49
Q	0.51	0.71
R	Φ3.5	Φ3.7
S	Φ7.1	Φ7.3