

MCP809/MCP810 3-Pin Microprocessor Reset Circuits

Check for Samples: [MCP809](#), [MCP810](#)

FEATURES

- Precise Monitoring of 3V, 3.3V, and 5V Supply Voltages
- Fully specified over temperature
- 140ms min. Power-On Reset Pulse Width, 240ms Typical
 - Active-low $\overline{\text{RESET}}$ Output (MCP809)
 - Active-high RESET Output (MCP810)
- Specified RESET Output Valid for $V_{CC} \geq 1V$
- Low Supply Current, 15 μA typical
- Power supply transient immunity

APPLICATIONS

- Microprocessor Systems
- Computers
- Controllers
- Intelligent Instruments
- Portable/Battery-Powered Equipment
- Automotive

Typical Application Circuit

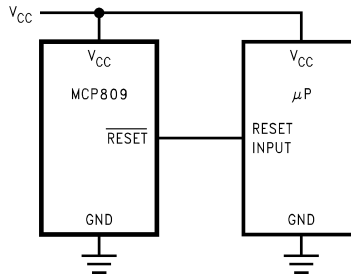
Figure 1. Typical Application Circuit

Connection Diagram

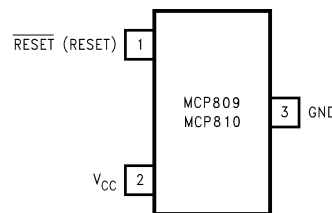
Figure 2. () are for MCP810

Please be aware that an important notice concerning availability, standard warranty, and use in critical applications of Texas Instruments semiconductor products and disclaimers thereto appears at the end of this data sheet.

All trademarks are the property of their respective owners.

Pin Description

PIN	NAME	FUNCTION
3	GND	Ground reference
1	$\overline{\text{RESET}}$ (MCP809)	Active-low output. $\overline{\text{RESET}}$ remains low while V_{CC} is below the reset threshold, and for 240ms after V_{CC} rises above the reset threshold.
	RESET (MCP810)	Active-high output. RESET remains high while V_{CC} is below the reset threshold, and for 240ms after V_{CC} rises above the reset threshold.
2	V_{CC}	Supply Voltage (+5V, +3.3V, or +3.0V)



These devices have limited built-in ESD protection. The leads should be shorted together or the device placed in conductive foam during storage or handling to prevent electrostatic damage to the MOS gates.

Absolute Maximum Ratings ⁽¹⁾

V_{CC}	-0.3V to 6.0V
RESET, $\overline{\text{RESET}}$	-0.3V to ($V_{CC} + 0.3V$)
Input Current, V_{CC} Pin	20mA
Output Current, RESET, $\overline{\text{RESET}}$ Pin	20mA
Rate of Rise, V_{CC}	100V/ μ s
ESD Rating ⁽²⁾	2kV
Continuous Power Dissipation ($T_A = +70^\circ\text{C}$)	
SOT-23 ⁽³⁾	320mW
Ambient Temperature Range	-40°C to +105°C
Maximum Junction Temperature	125°C
Storage Temperature Range	-65°C to +160°C
Lead Temperature (soldering, 10sec)	+300°C

(1) Absolute Maximum Ratings are limits beyond which damage to the device may occur. Operating Ratings are conditions under which the device operates correctly. Operating ratings do not imply specified performance limits. For specified performance limits and associated test conditions, see the Electrical Characteristics.

(2) The human body model is a 100pF capacitor discharged through a 1.5k Ω resistor into each pin.

(3) Production testing done at $T_A = +25^\circ\text{C}$, over temperature limits specified by design only.

Electrical Characteristics

V_{CC} = full range, T_A = -40°C to $+105^{\circ}\text{C}$, unless otherwise noted. Typical values are at T_A = $+25^{\circ}\text{C}$, V_{CC} = 5V for 4.63/4.38/4.00 versions, V_{CC} = 3.3V for 3.08/2.93 versions, and V_{CC} = 3V for 2.63 version. ⁽¹⁾

Symbol	Parameter	Conditions	Min	Typ	Max	Units			
	V_{CC} Range	T_A = 0°C to $+70^{\circ}\text{C}$	1.0		5.5	V			
		T_A = -40°C to $+105^{\circ}\text{C}$	1.2		5.5				
I_{CC}	Supply Current	T_A = -40°C to $+85^{\circ}\text{C}$	$V_{CC} < 5.5\text{V}$, MCP8__ - 4.63/4.38/4.00		18	60	μA		
			$V_{CC} < 3.6\text{V}$, MCP8__ - 3.08/2.93/2.63		15	50			
		T_A = $+85^{\circ}\text{C}$ to $+105^{\circ}\text{C}$	$V_{CC} < 5.5\text{V}$, MCP8__ - 4.63/4.38/4.00			100			
			$V_{CC} < 3.6\text{V}$, MCP8__ - 3.08/2.93/2.63			100			
V_{TH}	Reset Threshold ⁽²⁾	MCP8__ -4.63	T_A = $+25^{\circ}\text{C}$	4.56	4.63	4.70	V		
			T_A = -40°C to $+85^{\circ}\text{C}$	4.50		4.75			
			T_A = $+85^{\circ}\text{C}$ to $+105^{\circ}\text{C}$	4.40		4.86			
		MCP8__ -4.38	T_A = $+25^{\circ}\text{C}$	4.31	4.38	4.45			
			T_A = -40°C to $+85^{\circ}\text{C}$	4.25		4.50			
			T_A = $+85^{\circ}\text{C}$ to $+105^{\circ}\text{C}$	4.16		4.56			
		MCP8__ -4.00	T_A = $+25^{\circ}\text{C}$	3.93	4.00	4.06			
			T_A = -40°C to $+85^{\circ}\text{C}$	3.89		4.10			
			T_A = $+85^{\circ}\text{C}$ to $+105^{\circ}\text{C}$	3.80		4.20			
		MCP8__ -3.08	T_A = $+25^{\circ}\text{C}$	3.04	3.08	3.11			
			T_A = -40°C to $+85^{\circ}\text{C}$	3.00		3.15			
			T_A = $+85^{\circ}\text{C}$ to $+105^{\circ}\text{C}$	2.92		3.23			
		MCP8__ -2.93	T_A = $+25^{\circ}\text{C}$	2.89	2.93	2.96			
			T_A = -40°C to $+85^{\circ}\text{C}$	2.85		3.00			
			T_A = $+85^{\circ}\text{C}$ to $+105^{\circ}\text{C}$	2.78		3.08			
		MCP8__ -2.63	T_A = $+25^{\circ}\text{C}$	2.59	2.63	2.66			
			T_A = -40°C to $+85^{\circ}\text{C}$	2.55		2.70			
			T_A = $+85^{\circ}\text{C}$ to $+105^{\circ}\text{C}$	2.50		2.76			
			Reset Threshold Temperature Coefficient			30			ppm/ $^{\circ}\text{C}$
			V_{CC} to Reset Delay ⁽²⁾	$V_{CC} = V_{TH}$ to $(V_{TH} - 100\text{mV})$		20			μs
			Reset Active Timeout Period	T_A = -40°C to $+85^{\circ}\text{C}$	140	240		560	ms
				T_A = $+85^{\circ}\text{C}$ to $+105^{\circ}\text{C}$	100			840	

(1) At elevated temperatures, devices must be derated based on package thermal resistance. The device in the SOT23-3 package must be derated at 4mW/ $^{\circ}\text{C}$ at ambient temperatures above 70°C . The device has internal thermal protection.

(2) RESET Output for MCP809, RESET output for MCP810.

Electrical Characteristics (continued)

V_{CC} = full range, T_A = -40°C to $+105^{\circ}\text{C}$, unless otherwise noted. Typical values are at T_A = $+25^{\circ}\text{C}$, V_{CC} = 5V for 4.63/4.38/4.00 versions, V_{CC} = 3.3V for 3.08/2.93 versions, and V_{CC} = 3V for 2.63 version. ⁽¹⁾

Symbol	Parameter	Conditions	Min	Typ	Max	Units
V_{OL}	$\overline{\text{RESET}}$ Output Voltage Low (MCP809)	$V_{CC} = V_{TH \text{ min}}$, $I_{SINK} = 1.2\text{mA}$, MCP809-2.63/2.93/3.08			0.3	V
		$V_{CC} = V_{TH \text{ min}}$, $I_{SINK} = 3.2\text{mA}$, MCP809-4.63/4.38/4.00			0.4	
		$V_{CC} > 1.0\text{V}$, $I_{SINK} = 50\mu\text{A}$			0.3	
V_{OH}	$\overline{\text{RESET}}$ Output Voltage High (MCP809)	$V_{CC} > V_{TH \text{ max}}$, $I_{SOURCE} = 500\mu\text{A}$, MCP809-2.63/2.93/3.08	$0.8V_{CC}$			V
		$V_{CC} > V_{TH \text{ max}}$, $I_{SOURCE} = 800\mu\text{A}$, MCP809-4.63/4.38/4.00	$V_{CC}-1.5$			
V_{OL}	RESET Output Voltage Low (MCP810)	$V_{CC} = V_{TH \text{ max}}$, $I_{SINK} = 1.2\text{mA}$, MCP810-2.63/2.93/3.08			0.3	V
		$V_{CC} = V_{TH \text{ max}}$, $I_{SINK} = 3.2\text{mA}$, MCP810-4.63/4.38/4.00			0.4	
V_{OH}	RESET Output Voltage High (MCP810)	$1.8\text{V} < V_{CC} < V_{TH \text{ min}}$, $I_{SOURCE} = 150\mu\text{A}$	$0.8V_{CC}$			V

TYPICAL PERFORMANCE CHARACTERISTICS

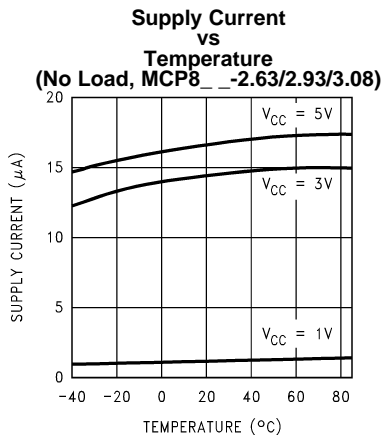

Figure 3.

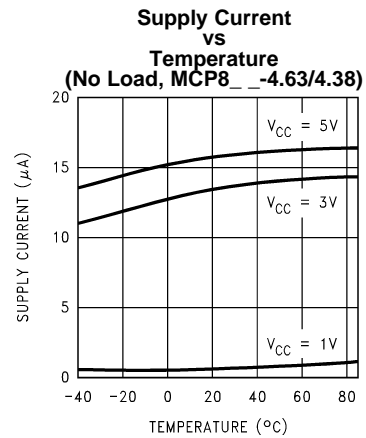

Figure 4.

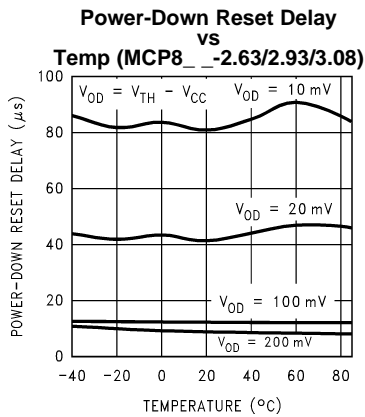

Figure 5.

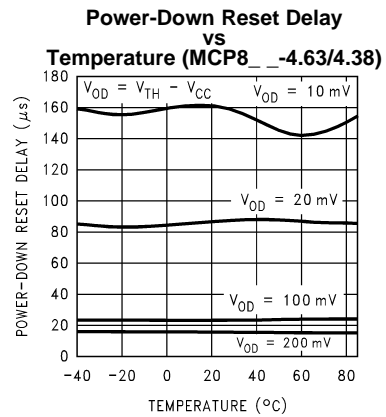

Figure 6.

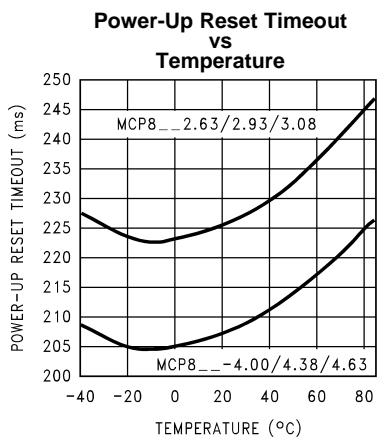

Figure 7.

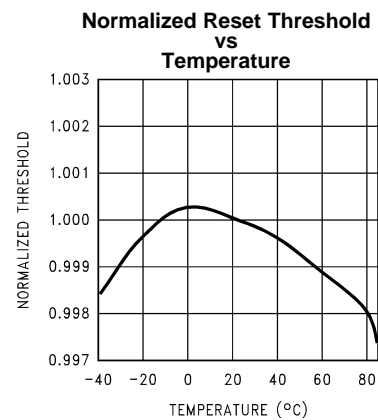

Figure 8.

APPLICATION INFORMATION

Benefits of Precision Reset Thresholds

A microprocessor supply supervisor must provide a reset output within a predictable range of the supply voltage. A common threshold range is between 5% and 10% below the nominal supply voltage. The 4.63V and 3.08V options of the MCP809/810 use highly accurate circuitry to ensure that the reset threshold occurs only within this range (for 5V and 3.3V supplies). The other voltage options have the same tight tolerance to ensure a reset signal for other narrow monitor ranges. See [Table 1](#) for examples of how the standard reset thresholds apply to 3V, 3.3V, and 5V nominal supply voltages.

Table 1. Reset Thresholds Related to Common Supply Voltages

Reset Threshold	3.0V	3.3V	5.0V
4.63 ± 3%			90 - 95%
4.38 ± 3%			85 - 90%
4.00 ± 3%			78 - 82%
3.08 ± 3%		90 - 95%	
2.93 ± 3%		86 - 90%	
2.63 ± 3%	85 - 90%	77 - 81%	

Ensuring a Valid Reset Output Down to $V_{CC} = 0V$

When V_{CC} falls below 1V, the MCP809 $\overline{\text{RESET}}$ output no longer sinks current. A high-impedance CMOS logic input connected to $\overline{\text{RESET}}$ can therefore drift to undetermined voltages. To prevent this situation, a 100k Ω resistor should be connected from the $\overline{\text{RESET}}$ output to ground, as shown in [Figure 9](#).

A 100k Ω pull-up resistor to V_{CC} is also recommended for the MCP810, if $\overline{\text{RESET}}$ is required to remain valid for $V_{CC} < 1V$.

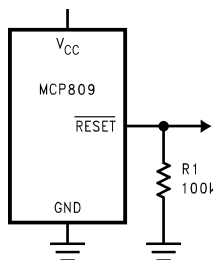

Figure 9. $\overline{\text{RESET}}$ Valid to $V_{CC} = \text{Ground}$ Circuit

Negative-Going V_{CC} Transients

The MCP809/810 are relatively immune to short negative-going transients or glitches on V_{CC} . [Figure 10](#) shows the maximum pulse width a negative-going V_{CC} transient can have without causing a reset pulse. In general, as the magnitude of the transient increases, going further below the threshold, the maximum allowable pulse width decreases. Typically, for the 4.63V and 4.38V version of the MCP809/810, a V_{CC} transient that goes 100mV below the reset threshold and lasts 20 μs or less will not cause a reset pulse. A 0.1 μF bypass capacitor mounted as close as possible to the V_{CC} pin will provide additional transient rejection.

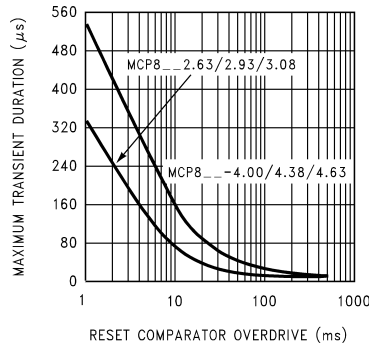

Figure 10. Maximum Transient Duration without Causing a Reset Pulse vs. Reset Comparator Overdrive

Interfacing to μ Ps with Bidirectional Reset Pins

Microprocessors with bidirectional reset pins, such as the Motorola 68HC11 series, can be connected to the MCP809 $\overline{\text{RESET}}$ output. To ensure a correct output on the MCP809 even when the microprocessor reset pin is in the opposite state, connect a 4.7k Ω resistor between the MCP809 $\overline{\text{RESET}}$ output and the μ P reset pin, as shown in Figure 11. Buffer the MCP809 $\overline{\text{RESET}}$ output to other system components.

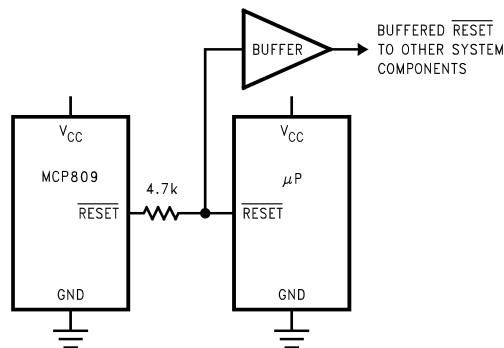

Figure 11. Interfacing to Microprocessors with Bidirectional Reset I/O

REVISION HISTORY

Changes from Original (May 2013) to Revision A	Page
• Changed layout of National Data Sheet to TI format	7

PACKAGING INFORMATION

Orderable Device	Status (1)	Package Type	Package Drawing	Pins	Package Qty	Eco Plan (2)	Lead finish/ Ball material (6)	MSL Peak Temp (3)	Op Temp (°C)	Device Marking (4/5)	Samples
MCP809M3-2.93/NOPB	ACTIVE	SOT-23	DBZ	3	1000	RoHS & Green	SN	Level-1-260C-UNLIM	-40 to 105	SRB	Samples

(1) The marketing status values are defined as follows:

ACTIVE: Product device recommended for new designs.

LIFEBUY: TI has announced that the device will be discontinued, and a lifetime-buy period is in effect.

NRND: Not recommended for new designs. Device is in production to support existing customers, but TI does not recommend using this part in a new design.

PREVIEW: Device has been announced but is not in production. Samples may or may not be available.

OBSOLETE: TI has discontinued the production of the device.

(2) **RoHS:** TI defines "RoHS" to mean semiconductor products that are compliant with the current EU RoHS requirements for all 10 RoHS substances, including the requirement that RoHS substance do not exceed 0.1% by weight in homogeneous materials. Where designed to be soldered at high temperatures, "RoHS" products are suitable for use in specified lead-free processes. TI may reference these types of products as "Pb-Free".

RoHS Exempt: TI defines "RoHS Exempt" to mean products that contain lead but are compliant with EU RoHS pursuant to a specific EU RoHS exemption.

Green: TI defines "Green" to mean the content of Chlorine (Cl) and Bromine (Br) based flame retardants meet JS709B low halogen requirements of <=1000ppm threshold. Antimony trioxide based flame retardants must also meet the <=1000ppm threshold requirement.

(3) MSL, Peak Temp. - The Moisture Sensitivity Level rating according to the JEDEC industry standard classifications, and peak solder temperature.

(4) There may be additional marking, which relates to the logo, the lot trace code information, or the environmental category on the device.

(5) Multiple Device Markings will be inside parentheses. Only one Device Marking contained in parentheses and separated by a "-" will appear on a device. If a line is indented then it is a continuation of the previous line and the two combined represent the entire Device Marking for that device.

(6) Lead finish/Ball material - Orderable Devices may have multiple material finish options. Finish options are separated by a vertical ruled line. Lead finish/Ball material values may wrap to two lines if the finish value exceeds the maximum column width.

Important Information and Disclaimer:The information provided on this page represents TI's knowledge and belief as of the date that it is provided. TI bases its knowledge and belief on information provided by third parties, and makes no representation or warranty as to the accuracy of such information. Efforts are underway to better integrate information from third parties. TI has taken and continues to take reasonable steps to provide representative and accurate information but may not have conducted destructive testing or chemical analysis on incoming materials and chemicals. TI and TI suppliers consider certain information to be proprietary, and thus CAS numbers and other limited information may not be available for release.

In no event shall TI's liability arising out of such information exceed the total purchase price of the TI part(s) at issue in this document sold by TI to Customer on an annual basis.

TAPE AND REEL INFORMATION

QUADRANT ASSIGNMENTS FOR PIN 1 ORIENTATION IN TAPE

*All dimensions are nominal

Device	Package Type	Package Drawing	Pins	SPQ	Reel Diameter (mm)	Reel Width W1 (mm)	A0 (mm)	B0 (mm)	K0 (mm)	P1 (mm)	W (mm)	Pin1 Quadrant
MCP809M3-2.93/NOPB	SOT-23	DBZ	3	1000	178.0	8.4	3.3	2.9	1.22	4.0	8.0	Q3

TAPE AND REEL BOX DIMENSIONS

*All dimensions are nominal

Device	Package Type	Package Drawing	Pins	SPQ	Length (mm)	Width (mm)	Height (mm)
MCP809M3-2.93/NOPB	SOT-23	DBZ	3	1000	208.0	191.0	35.0

GENERIC PACKAGE VIEW

DBZ 3

SOT-23 - 1.12 mm max height

SMALL OUTLINE TRANSISTOR

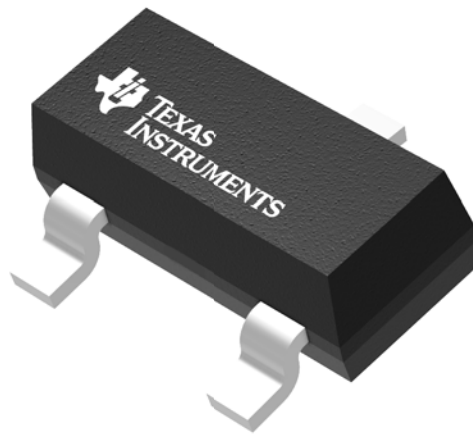

Images above are just a representation of the package family, actual package may vary.
Refer to the product data sheet for package details.

4203227/C

DBZ0003A

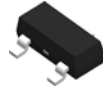

PACKAGE OUTLINE

SOT-23 - 1.12 mm max height

SMALL OUTLINE TRANSISTOR

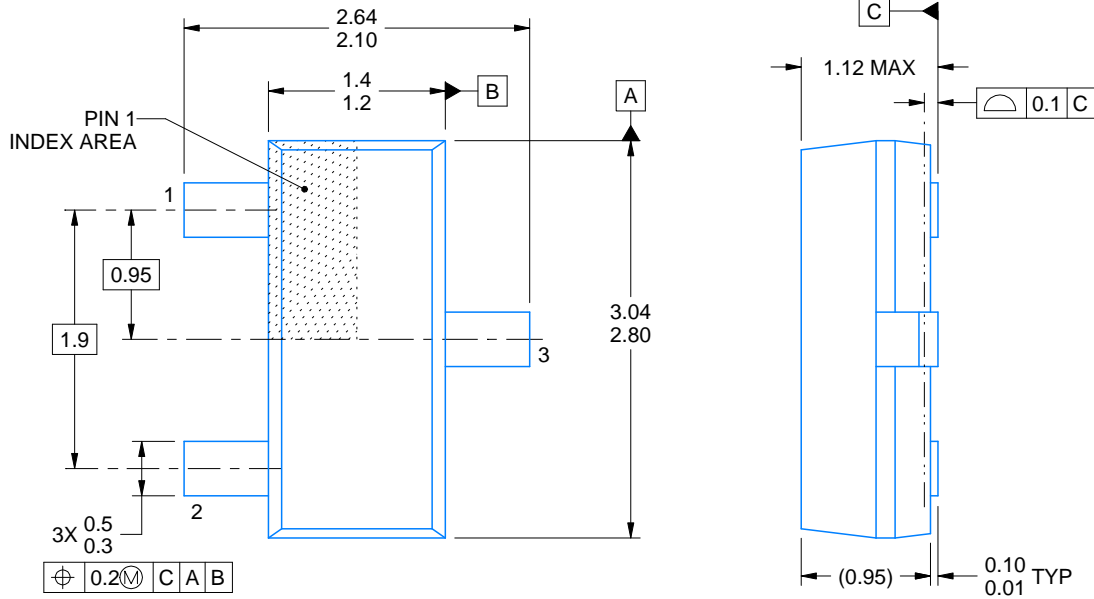

4214838/C 04/2017

NOTES:

1. All linear dimensions are in millimeters. Any dimensions in parenthesis are for reference only. Dimensioning and tolerancing per ASME Y14.5M.
2. This drawing is subject to change without notice.
3. Reference JEDEC registration TO-236, except minimum foot length.

EXAMPLE BOARD LAYOUT

DBZ0003A

SOT-23 - 1.12 mm max height

SMALL OUTLINE TRANSISTOR

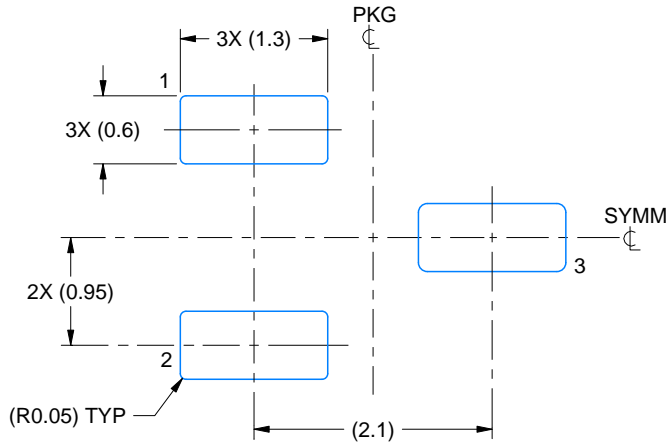

LAND PATTERN EXAMPLE
SCALE:15X

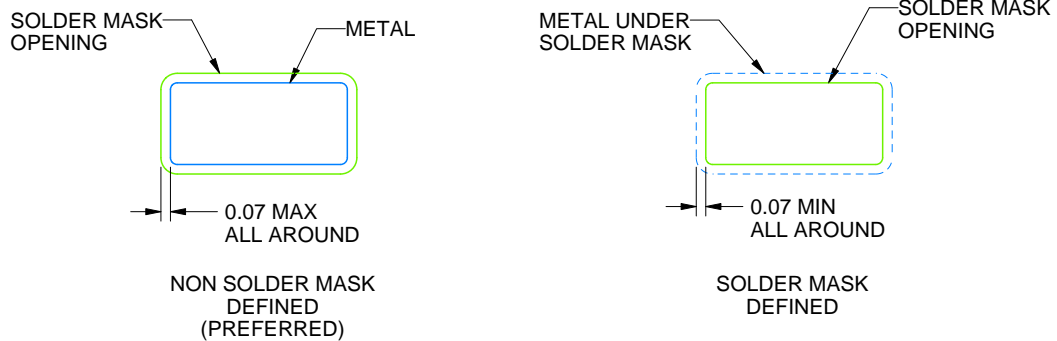

SOLDER MASK DETAILS

4214838/C 04/2017

NOTES: (continued)

4. Publication IPC-7351 may have alternate designs.
5. Solder mask tolerances between and around signal pads can vary based on board fabrication site.

EXAMPLE STENCIL DESIGN

DBZ0003A

SOT-23 - 1.12 mm max height

SMALL OUTLINE TRANSISTOR

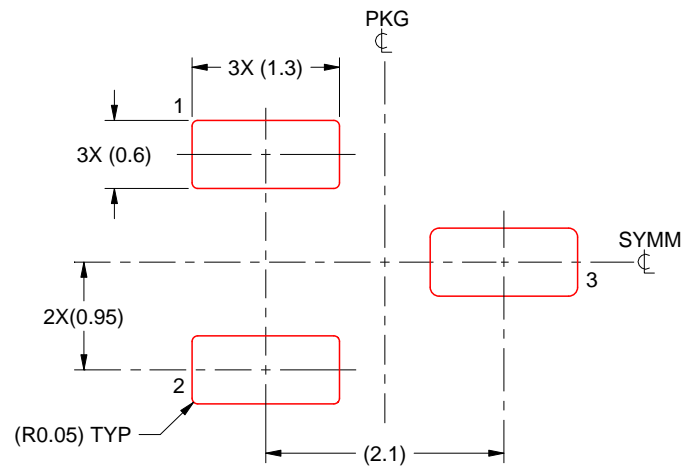

SOLDER PASTE EXAMPLE
BASED ON 0.125 THICK STENCIL
SCALE:15X

4214838/C 04/2017

NOTES: (continued)

6. Laser cutting apertures with trapezoidal walls and rounded corners may offer better paste release. IPC-7525 may have alternate design recommendations.
7. Board assembly site may have different recommendations for stencil design.

IMPORTANT NOTICE AND DISCLAIMER

TI PROVIDES TECHNICAL AND RELIABILITY DATA (INCLUDING DATA SHEETS), DESIGN RESOURCES (INCLUDING REFERENCE DESIGNS), APPLICATION OR OTHER DESIGN ADVICE, WEB TOOLS, SAFETY INFORMATION, AND OTHER RESOURCES "AS IS" AND WITH ALL FAULTS, AND DISCLAIMS ALL WARRANTIES, EXPRESS AND IMPLIED, INCLUDING WITHOUT LIMITATION ANY IMPLIED WARRANTIES OF MERCHANTABILITY, FITNESS FOR A PARTICULAR PURPOSE OR NON-INFRINGEMENT OF THIRD PARTY INTELLECTUAL PROPERTY RIGHTS.

These resources are intended for skilled developers designing with TI products. You are solely responsible for (1) selecting the appropriate TI products for your application, (2) designing, validating and testing your application, and (3) ensuring your application meets applicable standards, and any other safety, security, regulatory or other requirements.

These resources are subject to change without notice. TI grants you permission to use these resources only for development of an application that uses the TI products described in the resource. Other reproduction and display of these resources is prohibited. No license is granted to any other TI intellectual property right or to any third party intellectual property right. TI disclaims responsibility for, and you will fully indemnify TI and its representatives against, any claims, damages, costs, losses, and liabilities arising out of your use of these resources.

TI's products are provided subject to [TI's Terms of Sale](#) or other applicable terms available either on ti.com or provided in conjunction with such TI products. TI's provision of these resources does not expand or otherwise alter TI's applicable warranties or warranty disclaimers for TI products.

TI objects to and rejects any additional or different terms you may have proposed.

Mailing Address: Texas Instruments, Post Office Box 655303, Dallas, Texas 75265
Copyright © 2021, Texas Instruments Incorporated