

4 CIRCUIT SHOWN

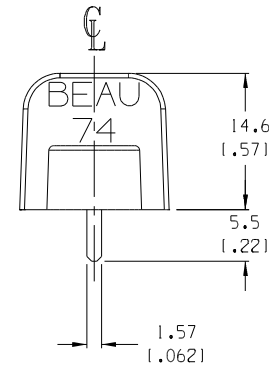

NOTES:

1. MATERIAL: SEE TABLE
2. FINISHES: SEE TABLE
3. PRODUCT SPECIFICATION: NOT REQUIRED
4. PACKAGING: NOT REQUIRED
5. MATES WITH: NONE
6. "XX" REFERS TO THE QUANTITY OF CIRCUITS.

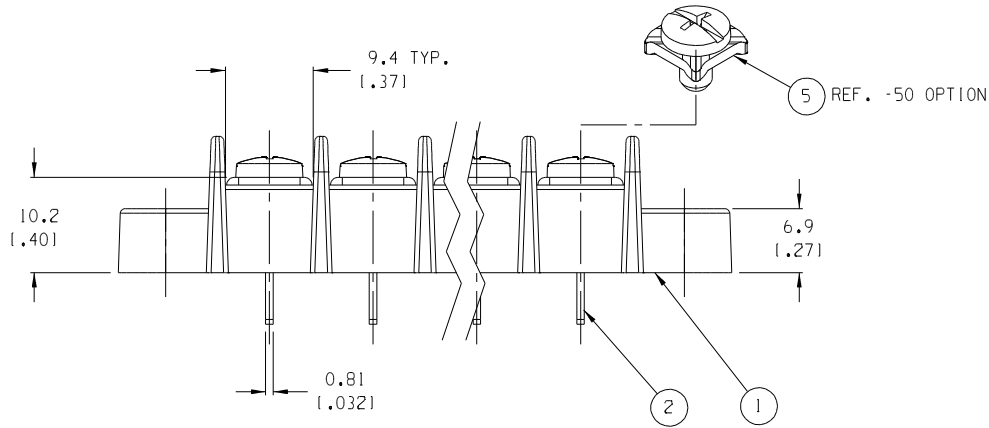



ITEM	QTY.	DESCRIPTION	MATERIAL	FINISH
5	XX	SCREW W/SH. WASHER, #6-32X.250,PAN HD,PHIL-SLOT, -50 OPT.	STEEL	ZN, CLEAR CHROMATE
4	XX	SCREW, #6-32X.250, BIND. HD, PHIL-SLOT, -49 OPT.	BRASS	NICKEL PLATE
3	XX	SCREW, #6-32X.250, BIND. HD, PHIL-SLOT, STANDARD	STEEL	ZN, CLEAR CHROMATE
2	XX	TERMINAL, PC	BRASS	TIN PLATE
1	I	INSULATOR, SINGLE ROW	VALOX	BLACK

EC NO. RELEASED DRW'G: CH'K: APPR:	MAJOR
	CRITICAL
DESCRIPTION	SPC
	REV

QUALITY SYMBOLS	GENERAL TOLERANCES: (UNLESS SPECIFIED)	SCALE 2:1	DESIGN UNITS <input type="checkbox"/> mm <input checked="" type="checkbox"/> INCH	THIRD ANGLE PROJECTION
	mm	INCH	DRAWN BY & DATE C. YORK 05-10-05	TITLE: 11.11 (1.438) SR BTS ASSY, LOW PROFILE
	4 PLACES ±.0015		CHECKED BY & DATE	MATERIAL NO. SEE CHART
	3 PLACES ±.038 ±.005		APPROVED BY & DATE	
	2 PLACES ±.13 ±.01		CAD FILENAME 745XX	DRAWING NO. SD-38740-002
	1 PLACE ±.3		ANGULAR: ±2°	SHEET NO. 1 OF 2
	DRAFT WHERE APPLICABLE MUST REMAIN WITHIN DIMENSIONS			THIS DRAWING CONTAINS INFORMATION THAT IS PROPRIETARY TO MOLEX INCORPORATED AND SHOULD NOT BE USED WITHOUT WRITTEN PERMISSION.

PROJECT NO. -	-	-
DIMENSIONS:	<input checked="" type="checkbox"/> mm	<input type="checkbox"/> INCH
	<input type="checkbox"/> mm	<input type="checkbox"/> INCH
	<input type="checkbox"/> mm ONLY	
	SHT	REV
		REVISE ON CAD ONLY

# OF CIRC. "XX"	DIM. "A"	DIM. "B"	DIM. "C"	DIM. "D"	ASSEMBLY MATERIAL NO. (STANDARD)	ASSEMBLY MATERIAL NO. (-49 OPTION)	ASSEMBLY MATERIAL NO. (-50 OPTION)
02	43.5 (1.711)	11.11 (.438)	33.34 (1.313)	24.5 (1.97)	387406102	387406702	387407302
03	54.6 (2.15)	22.23 (.875)	44.45 (1.750)	35.7 (1.401)	387406103	387406703	387407303
04	65.7 (2.59)	33.34 (1.313)	55.56 (2.188)	46.8 (1.84)	387406104	387406704	387407304
05	76.8 (3.03)	44.45 (1.750)	66.68 (2.625)	57.9 (2.281)	387406105	387406705	387407305
06	87.9 (3.46)	55.56 (2.188)	77.79 (3.063)	69.0 (2.72)	387406106	387406706	387407306
07	99.1 (3.90)	66.68 (2.625)	88.90 (3.500)	80.1 (3.15)	387406107	387406707	387407307
08	110.2 (4.34)	77.79 (3.063)	100.01 (3.938)	91.2 (3.59)	387406108	387406708	387407308
09	121.3 (4.78)	88.90 (3.500)	111.13 (4.375)	102.3 (4.03)	387406109	387406709	387407309
10	132.4 (5.21)	100.01 (3.938)	122.24 (4.813)	113.4 (4.47)	387406110	387406710	387407310
11	143.5 (5.65)	111.13 (4.375)	133.35 (5.250)	124.6 (4.90)	387406111	387406711	387407311
12	154.6 (6.09)	122.24 (4.813)	144.46 (5.688)	135.7 (5.34)	387406112	387406712	387407312
13	165.7 (6.53)	133.35 (5.250)	155.58 (6.125)	146.8 (5.78)	387406113	387406713	387407313
14	176.8 (6.96)	144.46 (5.688)	166.69 (6.563)	157.9 (6.22)	387406114	387406714	387407314
15	188.0 (7.40)	155.58 (6.125)	177.80 (7.000)	169.0 (6.65)	387406115	387406715	387407315
16	199.1 (7.84)	166.69 (6.563)	188.91 (7.438)	180.1 (7.09)	387406116	387406716	387407316
17	210.2 (8.28)	177.80 (7.000)	200.03 (7.875)	191.2 (7.53)	387406117	387406717	387407317
18	221.3 (8.71)	188.91 (7.438)	211.14 (8.313)	202.3 (7.97)	387406118	387406718	387407318
19	232.4 (9.15)	200.03 (7.875)	222.25 (8.750)	213.5 (8.40)	387406119	387406719	387407319
20	243.5 (9.59)	211.14 (8.313)	233.36 (9.188)	224.6 (8.84)	387406120	387406720	387407320
21	254.6 (10.03)	222.25 (8.750)	244.48 (9.625)	235.7 (9.28)	387406121	387406721	387407321
22	265.7 (10.46)	233.36 (9.188)	255.59 (10.063)	246.8 (9.72)	387406122	387406722	387407322
23	276.9 (10.90)	244.48 (9.625)	266.70 (10.500)	257.9 (10.15)	387406123	387406723	387407323
24	288.0 (11.34)	255.59 (10.063)	277.81 (10.938)	269.0 (10.59)	387406124	387406724	387407324
25	299.1 (11.78)	266.70 (10.500)	288.93 (11.375)	280.1 (11.03)	387406125	387406725	387407325
26	310.2 (12.21)	277.81 (10.938)	300.04 (11.813)	291.2 (11.47)	387406126	387406726	387407326
27	321.3 (12.65)	288.93 (11.375)	311.15 (12.250)	302.4 (11.90)	387406127	387406727	387407327
28	332.4 (13.09)	300.04 (11.813)	322.26 (12.688)	313.5 (12.34)	387406128	387406728	387407328
29	343.5 (13.53)	311.15 (12.250)	333.38 (13.125)	324.6 (12.78)	387406129	387406729	387407329
30	354.6 (13.96)	322.26 (12.688)	344.49 (13.563)	335.7 (13.22)	387406130	387406730	387407330

EC NO. _____ DRAWN: CH'K1 _____ APPR: _____ REV: _____	DESCRIPTION: _____ MAJOR:  CRITICAL:  SPC:  S: 	QUALITY SYMBOLS		GENERAL TOLERANCES: (UNLESS SPECIFIED)		SCALE: --	DESIGN UNITS: <input type="checkbox"/> mm <input checked="" type="checkbox"/> INCH	THIRD ANGLE PROJECTION: 	PROJECT NO.: - - -	DIMENSIONS: <input checked="" type="checkbox"/> mm <input type="checkbox"/> INCH <input type="checkbox"/> mm ONLY	SHT: - - REV: - -					
		4 PLACES: mm ±.0015 INCH ±.0015	3 PLACES: mm ±.038 INCH ±.005	2 PLACES: mm ±.13 INCH ±.01	1 PLACE: mm ±.3 INCH ±.01	ANGULAR: ±2°	DRAFT WHERE APPLICABLE MUST REMAIN WITHIN DIMENSIONS	DRAWN BY & DATE: C. YORK 05-10-05	CHECKED BY & DATE:	APPROVED BY & DATE:	TITLE: 11.11 (.438) SR BTS ASSY, LOW PROFILE	MOLEX INCORPORATED	CAD FILENAME: 745XX	MATERIAL NO.: SEE CHART	DRAWING NO.: SD-38740-002	SHEET NO.: 2 OF 2
		THIS DRAWING CONTAINS INFORMATION THAT IS PROPRIETARY TO MOLEX INCORPORATED AND SHOULD NOT BE USED WITHOUT WRITTEN PERMISSION.										SIZE: B				