

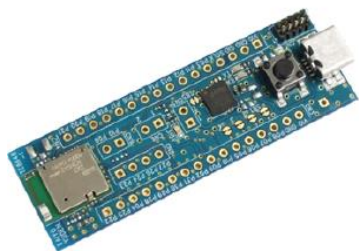

CONTiNECT

Wireless Solution

Bluetooth® low energy Sensing Evaluate Solution



1. Sensing Evaluate Solution Overview
2. Challenges for foretasting a sensor network
3. Benefits of Sensing Evaluate Solution
4. Contents of Solution
 1. Hardware
 2. Corresponding BLE evaluation kits and boards
 3. Three types of Firmware
 4. List of Firmware, Applications and Documents
5. Handling method of the sensor socket
6. Introduction of Bluetooth[®] low energy Development Tools
7. Power supply method for sensor socket
8. Bluetooth[®] low energy Module Reference

1. Sensing Evaluate Solution Overview

Easy startup of Internet-of-Things with low-power wireless technology

The operation has been checked with a combination of 2.4 GHz (802.15.1) BLE Evaluation Kit/Board, Sensor Socket, Three types of firmware and common sensors. So, it is the best suited for foretaste of IoT and your PoC or hypothesis verification.

<Contents of Sensing Evaluate Solution>

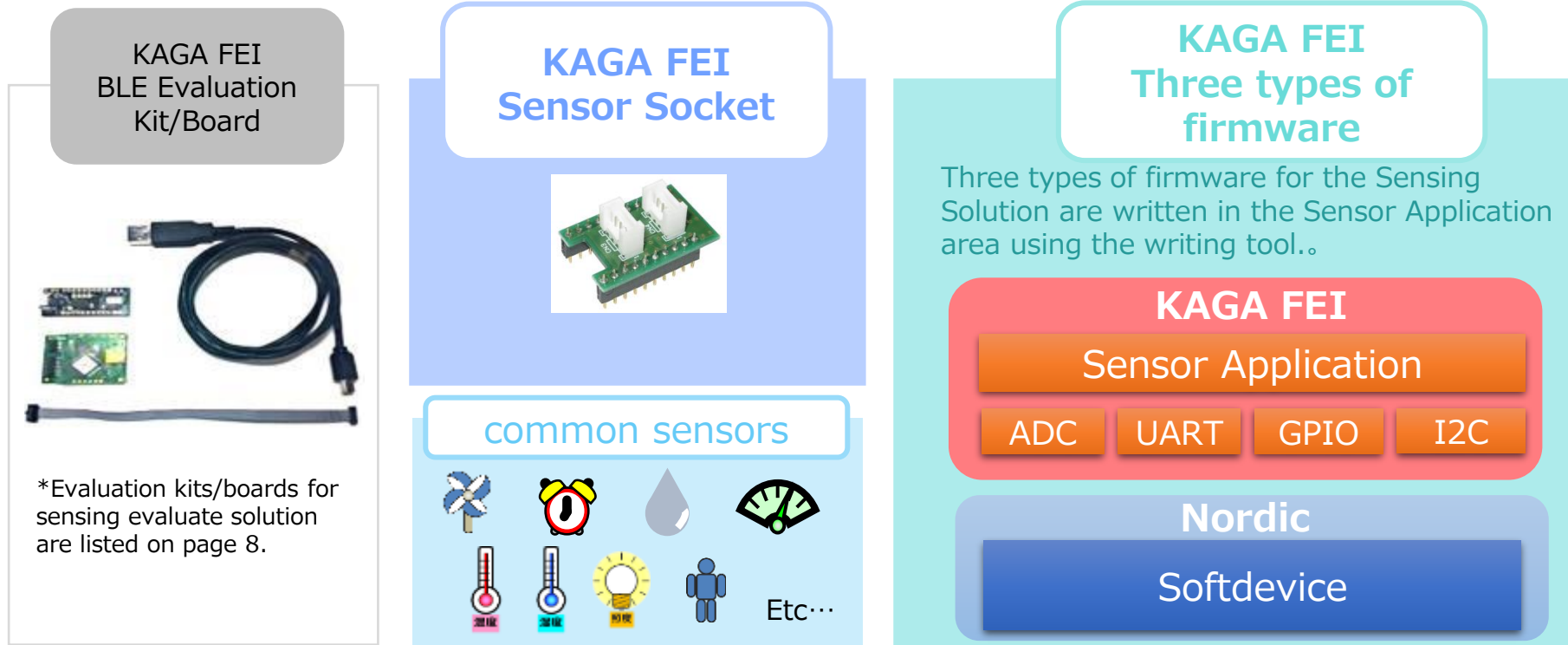

User issues



- System development is complicated (Development of source code and settings are required for each device)
 - => **Development man-hours are large and unpredictable.**
- The system configuration is large in the starter kit that is already on the market
 - => **Small degree of freedom in design.**

Conventional configuration example :

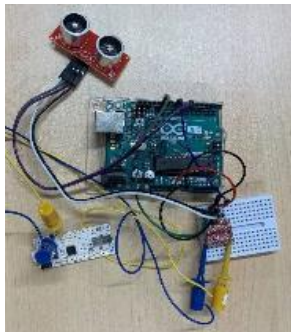

Microcomputer board (Raspberry Pi, etc.)
+
Wireless device
+
I/F board
+
Various sensors

- At the time of various evaluations (BLE communication, Sensor operation, etc.), it is necessary to prepare each evaluation environment.
 - **Several evaluation environments need to be prepared.**
- Since the design starts from the PoC stage, it may take time to move to a configuration close to a prototype (mass production product).
 - **Large number of man-hours for examination and evaluation.**

3 .Benefits of Sensing Evaluate Solution

In the case of using Sensing Evaluate Solution..

- Three types of firmware are prepared for each application and a socket for sensor connection suitable for common sensors. System development is easy, and you only need to write the firmware to the evaluation board. So, you can operate it without development. Source codes and various manuals are available.
→ **The initial development man-hours are small. Realize small start of verification.**

- Compact system configuration
→ **There is design flexibility and it is easy to handle.**

BLE Sensing Evaluate Solution configuration :



Nordic SoC built-in module (ARM)
+
Sensor Socket
+
Common sensors



- Dedicated applications which is required for various evaluations (BLE communication, sensor operation, etc.) can be provided. *Android OS、iOS application (TY’s Terminal, TYs SensorKit).
→ **Evaluation environment preparation is not required, and evaluation and verification can be performed immediately.**
- Since our standard evaluation board is used, it can be evaluated immediately with a configuration close to a prototype (mass production product).
→ **Evaluation man-hours can be reduced with no waste and small startup.**

Comparison summary with the conventional system

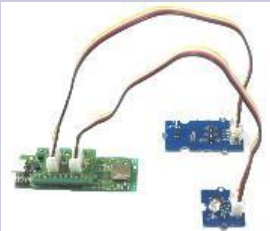
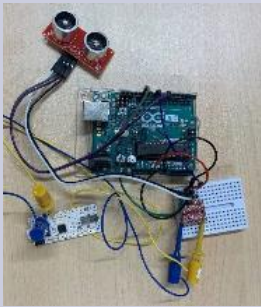
	KAGA FEI Sensing Evaluate Solution	Conventional system configuration
System overview	 <p>Nordic SoC Built-in Module (ARM) + Sensor Socket + common sensors</p> <p>✓ One package for Sensor Node Development</p>	 <p>Microcomputer board (Raspberry Pi etc.) + Wireless device + I/F board + Various sensors</p>
Selection and procurement of parts	<p>✓ one day As it has been evaluated, it can be procured without hesitation.</p>	<p>About a week Survey of each device, individual purchase.</p>
Software development on the device side	<p>✓ No development required Firmware ready for evaluation. Just download and write into the board.</p>	<p>one week ~ Needs development for microcomputers, wireless ICs, and sensors.</p>
Smartphone / tablet app	<p>✓ No development required Evaluation App. is available.</p>	<p>one week ~ one week for research and development</p>
Days to start verification	<p>✓ Start immediately after purchase</p>	<p>Three weeks ~</p>

Verification can be started immediately with the minimum required system. Realize small start. Since it uses a BLE device with a built-in CPU, it is possible to evaluate without waste because of the configuration close to a prototype (mass production product).

4. Contents of Solution –Hardware–

Evaluation Kit



EY1SENSOR-SKT (Socket)



Common Sensors



- This solution contains a sensor socket "EY1SENSOR-SKT", Bluetooth® low energy evaluation board/kit, common Sensors and firmware provided by our company.
- These can be purchased from online distributors.
- Supported sensors vary depending on the firmware that you use.
Please refer to P11, P14, and P15 for details on the sensors supported by each firmware.
- Supported firmware and documentation are available on our company website.
https://www.kagafei.com/jp/eng/wireless_modules/bluetooth/ey1sensor-kit.html
- If you have an evaluation board/kit that supports sensing evaluate solution, you do not need to purchase it again. Please refer to P8 for supported evaluation Kit/Board.

4. Contents of Solution

-List of corresponding evaluation kits / boards-

Corresponding evaluation board

Board Part No.	EBSKJNZWB	EBSHCNZWZ	EBSHJNZWZ	EBSHSNZWZ	EBSNCNZWW	EBSNSNZWW
SoC	nRF52840	nRF52832	nRF52832	nRF52832	nRF52811	nRF52811
Board Size[mm]	19.4x44.2x8.1	19.8x60.0x8.1	19.4x44.2x8.1	19.4x44.2x8.1	19.8x60.0x8.1	19.4x44.2x8.1
Module Size[mm]	5.1x11.3x1.3	9.6x12.9x2.0	5.1x11.3x1.3	3.25x8.55x0.85	9.6x12.9x2.0	3.25x8.55x1.00
Board I/F	UART	UART	UART	UART	UART	UART
Module I/O	UART, SPI, I2C, I2S, PDM	UART, SPI, I2C, I2S, PDM	UART, SPI, I2C, I2S, PDM	UART, SPI, I2C, I2S, PDM	UART, SPI, I2C, PDM	UART, SPI, I2C, PDM
Softdevice	S140	S132	S132	S132	S112/S113	S112/S113
	Long Range				Long Range	Long Range

Board Part No.	EBSLCNZWW	EBLSNZWW
SoC	nRF52810	nRF52810
Board Size[mm]	19.8x60.0x8.1	19.4x44.2x8.1
Module Size[mm]	9.6x12.9x2.0	3.25x8.55x1.00
Board I/F	UART	UART
Module I/O	UART, SPI, I2C, PDM	UART, SPI, I2C, PDM
Softdevice	S112	S112

Evaluation Board

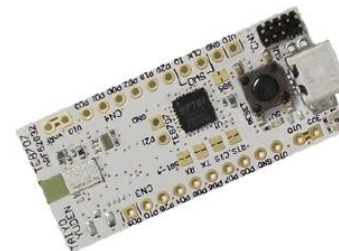

Evaluation Kit



*A debugger is required for writing firmware. Our company does not sell debuggers by themselves, so if you do not have one, please purchase an evaluation kit (the second digit of the item name is "K").

4 . Contents of Solution

- 3 types of FW Lineup -



	Firmware	Target sensor	What can do	Target users	Necessary parts
A	3 types of sensors trial	Seeed sensors (Temperature, Light, 3-Axis Digital Accelerometer)	BLE transmission of target sensor data	Those who want to try BLE communication of sensor data of temperature, illuminance, and acceleration. <u>No software expertise required.</u>	- EY1SENSOR-SKT - BLE Evaluation Kit - Operation confirmed sensor (See sensor list)
B	18 types of sensors CLI operation	18 types of sensors that have been confirmed to work with us	BLE transmission of target sensor data. Sensor switching can be command-controlled from a PC CLI-FW (CLI: Command Line Interface)	Those who want to try BLE communication of more sensor data. <u>No software expertise required.</u>	- EY1SENSOR-SKT - BLE Evaluation Kit - Operation confirmed sensor (See sensor list)
C	Multi-sensor Arduino Wrapper	Drivers provided for Arduino Sensors provided	BLE transmission of target sensor data. You can also try our unverified sensors. It is possible for you to customize the provided Firmware.	Those who want to try BLE communication with more sensors than B. <u>Those who have software expertise.</u>	- EY1SENSOR-SKT - BLE Evaluation Kit - Sensors with Arduino drivers

A. Three types of sensors trial

Firmware use image

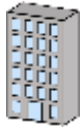

Available from Electric Commerce
Sensor socket
EY1SENSOR-SKT

Supporting
common sensors

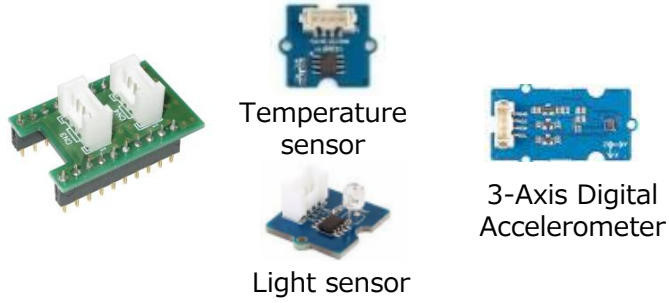

Write the firmware
into module



Attached to the evaluation
board using Sensor Socket

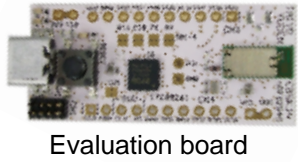

Connection image

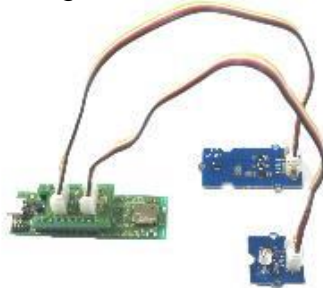

advertise



Smartphone Application
TY's Terminal

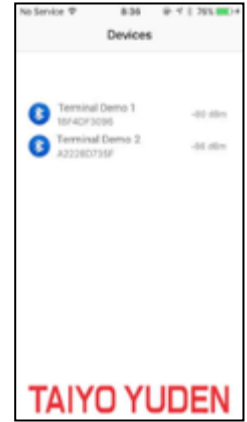



Nordic Thingy

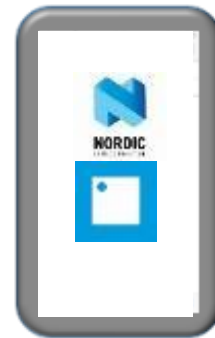

connection



Supported Sensor List

No.	Name		Type	IC	Maker	ID / Ref #	Protocol	
1	IMU-BMA	3-Axis Digital Accelerometer(BMA400) Ultra low power consumption type		IMU	BMA-400	Seeed	101020582	I2C
2	LIGHT	Light sensor		ADC light level		Seeed	101020132	ADC
3	TEMP-ADC	Temperature sensor		ADC temperature		Seeed	101020015	ADC

Module Firmware

Type	File Name
Firmware for Beacon	Multisensor_Borad_"Partnumber"_beacon.zip
Sample code for Beacon	Multisensor_Borad_Beacon_vX.YY.zip
Connection firmware for thingy	Multisensor_Borad_"Partnumber"_connection_by_thingy.zip

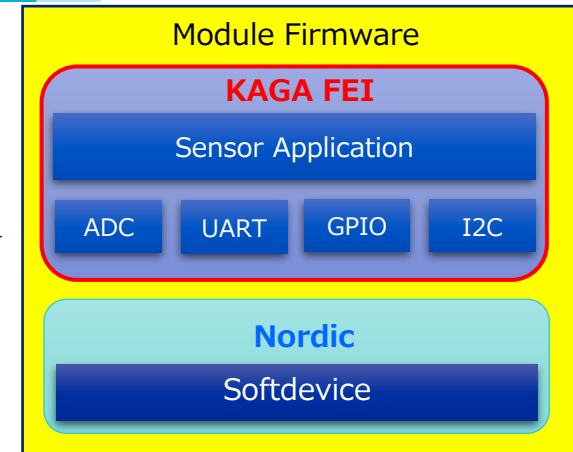

Smartphone and tablet application

Appication Name	Supported OS	Provider
TY's Terminal	iOS : 12.1 or later, Android : 4.3 or later	TAIYO YUDEN
Thingy	iOS : 9.0 or later, Android : 4.3 or later	Nordic

TY's Terminal



iOS

Android

Document

Document Name	Document File
Overview	Sensor_Kit_Overview_20200608.pdf
Sensor Node Development Kit operation manual	Multisensor_Board_Startup_Guide_EN.pdf
BLE manual	BLE-Development-Guide_EN.pdf
Beacon apprication operation manual	Multisensor_Board_Beacon-Terminal_UserManual_EN.pdf
Beacon application development manual	Multisensor-Board-Beacon-DevGuide_EN.pdf
Connection for Thingy operation manual	Multisensor_Board-Thingy_UserManual_EN.pdf

B. 18 types of sensors CLI Firmware use image

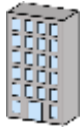

Available from Electric Commerce
Sensor socket
EY1SENSOR-SKT

Supporting
common sensors



Supports 18 types of sensors
Supported sensors are listed in
P14, P15

Smartphone Application TYs SensorKit

Write the firmware
into module



Attached to the evaluation
board using Sensor Socket

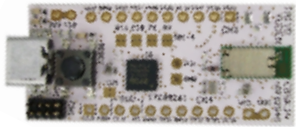

Evaluation board



Sensor Socket



advertise

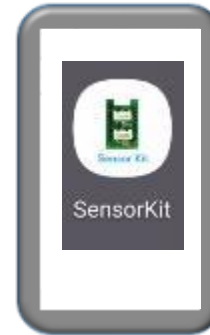



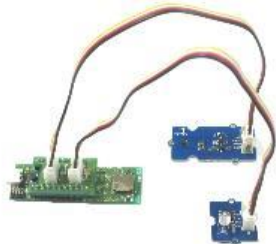





Connection image











Display sensor data

18 operation-confirmed sensor list 1/2

No.	Name		Type	IC	Maker	ID / Ref #	Protocol
1	IMU-BMA	3-Axis Digital Accelerometer(BMA400) Ultra low power consumption type		IMU	BMA-400	Seeed	101020582 I2C
2	IMU-ADX	3-Axis Digital Accelerometer ±200g (ADXL372)		IMU	ADXL372	Seeed	101020632 I2C
3	LIGHT	Light sensor		ADC light level		Seeed	101020132 ADC
4	TEMP-ADC	Temperature sensor		ADC temperature		Seeed	101020015 ADC
5	COLLISION	Grove Collision Sensor		Collision sensor		Seeed	101020005 Digital IO
6	LOUDNESS	Grove Loudness Sensor		Noise level sensor		Seeed	101020063 ADC
7	MAGSWITCH H	Magnetic switch		Magnetic switch		Seeed	101020038 Digital IO
8	ENV	(BME680)Temperature, humidity, atmospheric pressure, gas sensor		Environmental sensor	BME-680	Seeed	101020513 I2C
9	GESTURE	Motion sensor (Gesture module)		Gesture sensor		Seeed	101020083 I2C
10	ROTARY	Grove 12-bit Magnetic Rotary Position Sensor / Encoder		Rotary position sensor	AS5600	Seeed	101020692 I2C

18 operation-confirmed sensor list 2/2

No	Nae		Type	IC	Maker	ID / Ref #	Protocol
11	PRESSURE	High precision barometric pressure sensor (DPS310)		Air pressure sensor	DPS310	Seeed	101020812 I2C
12	CO2-SCD	CO2 sensor		CO2 Sensor	SCD41	Sensiron	SEK-SCD41-SENSOR I2C
13	TEMP-SHT35	High-precision temperature / humidity sensor		I2C temperature, humidity	SHT35	Seeed	101020592 I2C
14	MOTION	Adjustable PIR Motion Sensor		Motion sensor		Seeed	101020617 Digital IO
15	CO2-SCD30	Grove CO2 & Temperature & Humidity Sensor for Arduino 3 in 1"		Temperature, humidity, CO2	SCD30	Seeed	101020634 I2C
16	MULTIGAS	Gas sensor		Chemical gas sensor		Seeed	101020088 I2C
17	CURRENT	Current sensor (Equipped with ACS723)		Current sensor	ACS723		ACS723LLCTR-05AB-T2 ADC SFE-SEN-14544
18	ULTRASONIC	Ultrasonic Distance Sensor		Ultrasonic rangefinder		Seeed	101020010 Digital IO

Module Firmware

Type	File name
Firmware for Beacon	Multisensor_Board_ " Partnumber" _CLI_beacon.zip
Sample code for Beacon	MultiSensors_Board_Beacon_CLI_vX.YY.zip

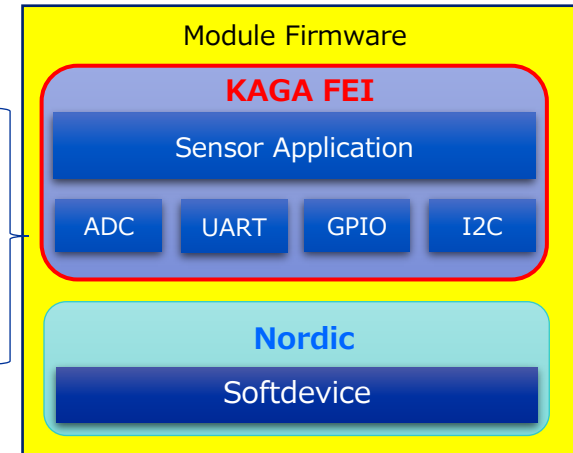

Smartphone and tablet application

Appication Name	Supported OS	Provider
TY's SensorKit	iOS : 12.1 or later, Android : 4.3 or later	TAIYO YUDEN

TY's SensorKit



iOS



Android

Document

Document Name	Document File
Overview	
Smartphone application operation manual	TYs SensorKit User Guide _EN.pdf
Beacon application operation manual	Multi sensor board CLI Guide_EN.pdf

C. Arduino Wrapper

Firmware use image

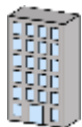

Available from Electric Commerce

Senser Socket
EY1SENSOR-SKT

Sensors with
Arduino drivers



Arduino drivers
available on GitHub



URL: <https://github.com/Seeed-Studio>

Smartphone Application TYs SensorKit

Inserting the sensor
driver into the firmware
and writing it into the
module

Attached to the evaluation
board using Sensor Socket



Evaluation board



Sensor Socket



advertise

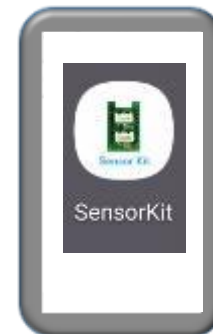

Connection image



Display sensor data

Contents of Firmware & Documents

Module Firmware

Type	File name
Firmware for Beacon	Multisensor_Board_ " Partnumber" _ArduinoWrapper_beacon.zip
Sample code for Beacon	MultiSensors_Board_Beacon_ArduinoWrapper_vX.YY.zip

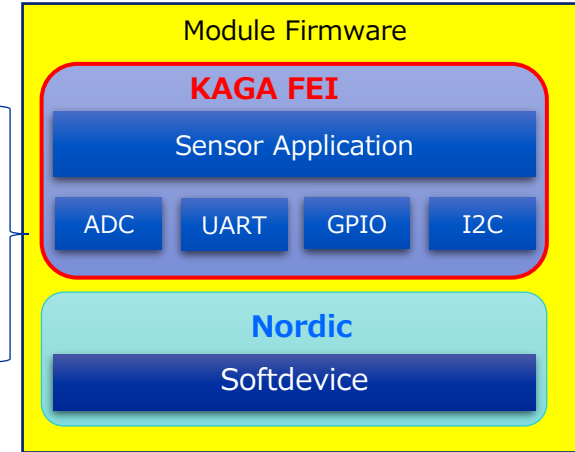

Smartphone and tablet application

Appellation Name	Supported OS	Provider
TY's SensorKit	iOS : 12.1 or later, Android : 4.3 or later	TAIYO YUDEN

TY's SensorKit



iOS



Android

Document

Document Name	Document File
Overview	
Smartphone application operation manual	TYs SensorKit User Guide _EN.pdf
Beacon application development manual	Multi sensor board DevGuide(Arduino wrapper) _EN.pdf

5. Handling method of the sensor socket

Note! : When you pull out the socket, be careful not to tilt it so that its terminals will not be deformed.

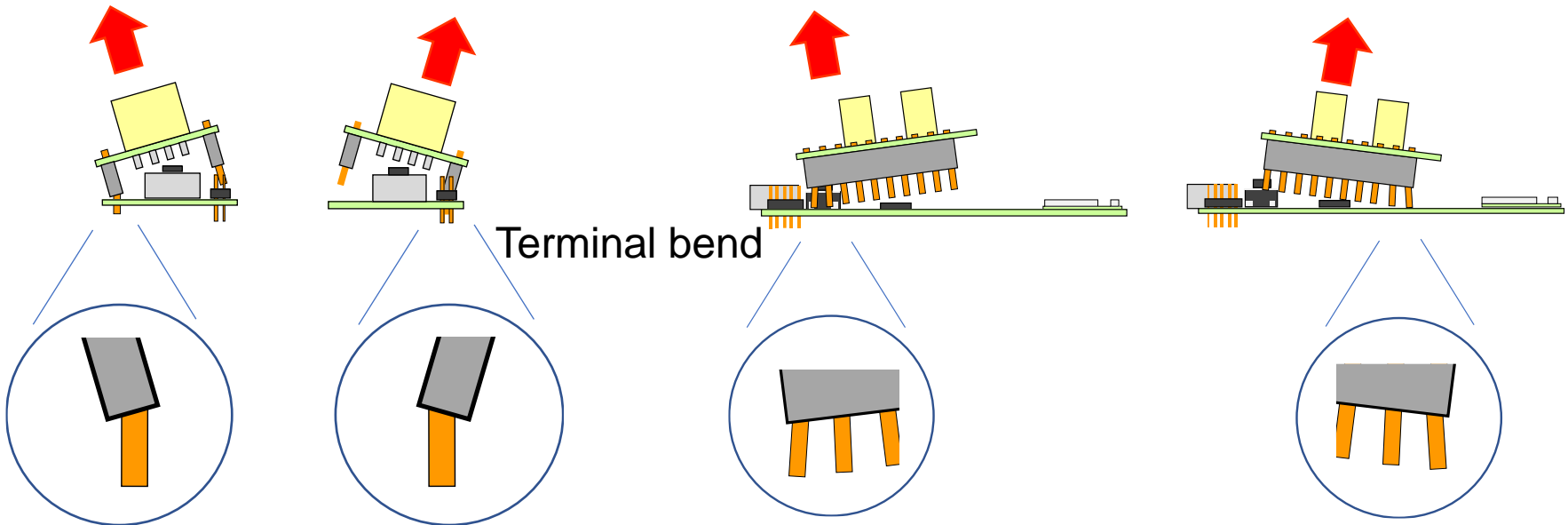
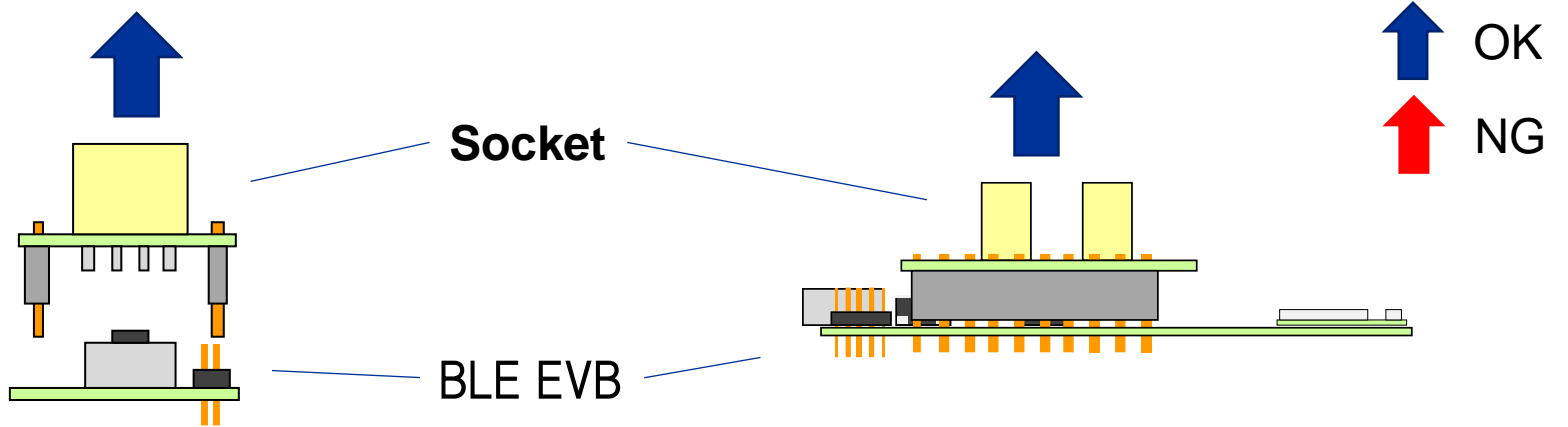

Current consumption Simulation and Measurement

Nordic Online Simulator

<https://devzone.nordicsemi.com/nordic/power>



- Supports nRF52832, nRF52840, nRF52810.
- By setting parameters, current waveform and current consumption can be simulated.

Nordic Power Profiler Kit II

<https://www.nordicsemi.com/Software-and-tools/Development-Tools/Power-Profiler-Kit-2>

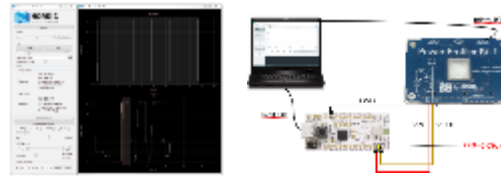

<App. Screen> <Connection example with TY module>

- Can measure current consumption without a special measuring instrument.
- When developing an application, you can easily evaluate current consumption under the actual operating condition.

Measure VSWR of antenna circuit

When incorporating the module on board or in housing, the resonance frequency of the antenna may shift. At such time, you can easily evaluate the resonance frequency and VSWR.

MS46121B series
1-port USB Vector network analyzer



7. Power supply method for Sensor Socket



Example of USB power supply

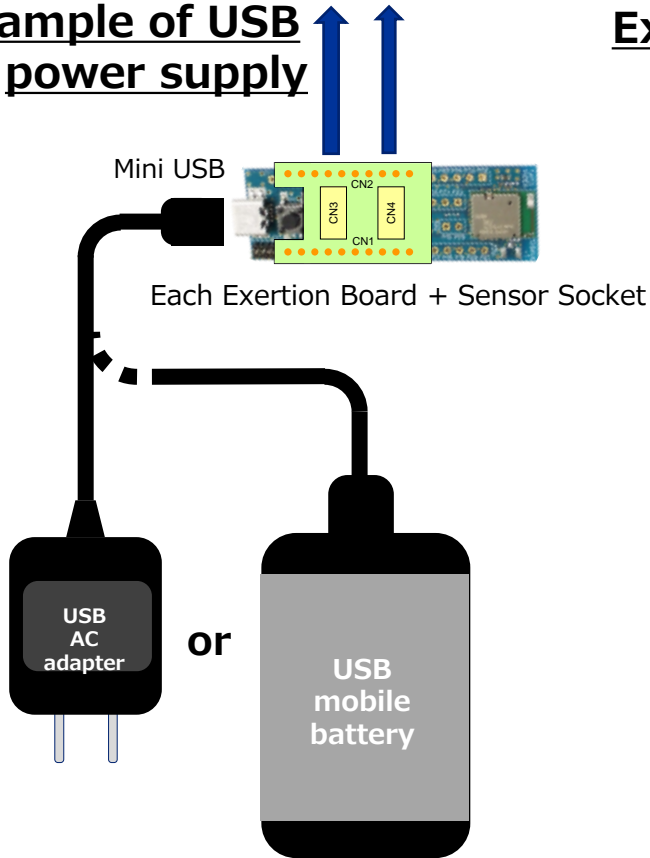

Example of battery power supply

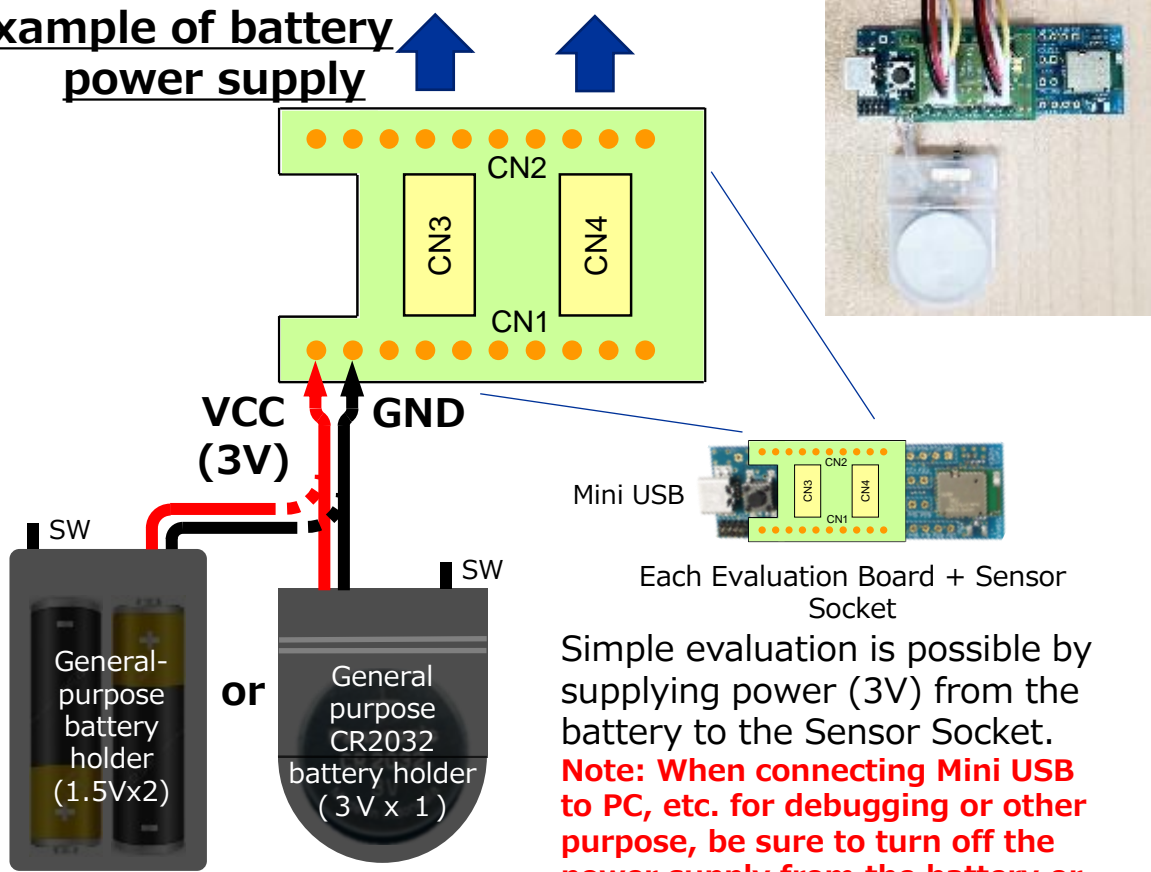

Simple evaluation is possible by supplying power (3V) from the battery to the Sensor Socket.

Note: When connecting Mini USB to PC, etc. for debugging or other purpose, be sure to turn off the power supply from the battery or disconnect the battery.

8. Bluetooth® low energy Module Reference

Control from embedded CPU

Temperature Sensor, Beacon, etc.

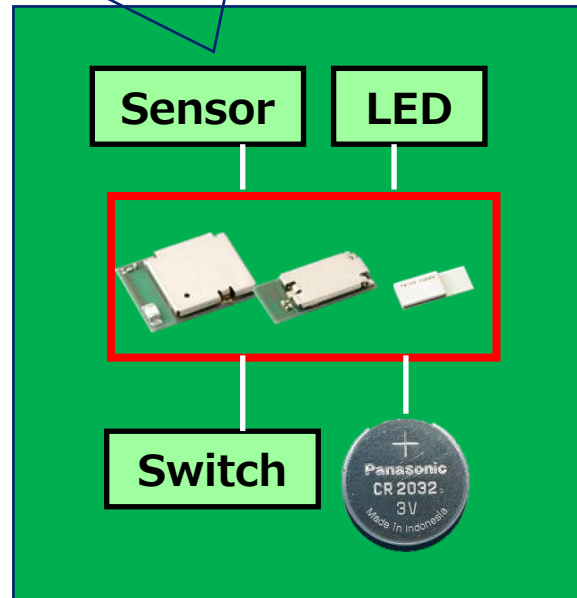
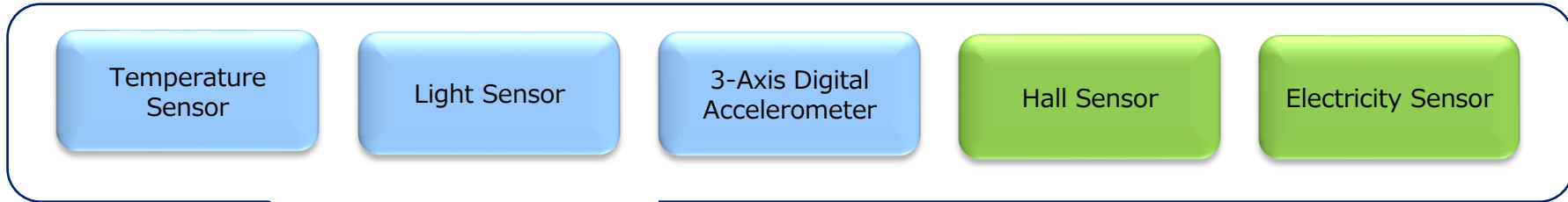



KAGA FEI