

Sensor/actuator cable - SAC-4P-M 8MS/ 0,6-600/M 8FR FB - 1406863

Please be informed that the data shown in this PDF Document is generated from our Online Catalog. Please find the complete data in the user's documentation. Our General Terms of Use for Downloads are valid (<http://phoenixcontact.com/download>)



Sensor/actuator cable, 4-position, PP-EPDM halogen-free, gray RAL 7035, Plug straight M8, on Socket angled M8, cable length: 0.6 m, Hygienic design, with plastic knurl

Your advantages

- ✓ Easy and safe: 100% electrically tested plug-in components
- ✓ Easy to clean, thanks to the special hygienic design
- ✓ Contamination can be detected quickly – thanks to the light color

Key Commercial Data

Packing unit	1 pc
GTIN	 4 046356 781855
GTIN	4046356781855

Technical data

Dimensions

Length of cable	0.6 m
-----------------	-------

Ambient conditions

Ambient temperature (operation)	-40 °C ... 105 °C (Plug / socket)
Degree of protection	IP65/IP68/IP69K

General

Rated current at 40°C	4 A
Rated voltage	48 V AC 60 V DC
Number of positions	4
Insulation resistance	≥ 100 MΩ
Coding	A - standard
Standards/regulations	M8 connector IEC 61076-2-104

Sensor/actuator cable - SAC-4P-M 8MS/ 0,6-600/M 8FR FB - 1406863

Technical data

General

	Material conformance FDA 21 CFR 177.2600
Status display	No
Protective circuit/component	unwired
Overvoltage category	II
Degree of pollution	3
Insertion/withdrawal cycles	≥ 100
Torque	0.2 Nm (M8 connectors)

Material

Contact material	CuSn
Contact surface material	Ni/Au
Contact carrier material	PP
Material of grip body	PP
Material, knurls	Polypropylene
Sealing material	FKM

Standards and Regulations

Standard designation	M8 connector
Standards/regulations	IEC 61076-2-104
Standard designation	Material conformance
Standards/regulations	FDA 21 CFR 177.2600

Cable

Cable type	Halogen-free PP gray
Cable type (abbreviation)	600
Cable abbreviation	Li9Y14Y
Conductor cross section	4x 0.25 mm ² (Signal line)
AWG signal line	24
Conductor structure signal line	32x 0.10 mm
Core diameter including insulation	1.17 mm ±0.02 mm (Signal line)
Thickness, insulation	≥ 0.21 mm (Core insulation)
Wire colors	brown, white, blue, black
Overall twist	4 wires, twisted
Length of twist, overall twist	44 mm
External sheath, color	gray RAL 7035
Outer sheath thickness	approx. 0.8 mm
External cable diameter D	4.5 mm ±0.15 mm
Minimum bending radius, fixed installation	5 x D
Minimum bending radius, flexible installation	10 x D
Number of bending cycles	4000000
Minimum bending radius, drag chain applications	10 x D
Traversing path	10 m

Sensor/actuator cable - SAC-4P-M 8MS/ 0,6-600/M 8FR FB - 1406863

Technical data

Cable

Traversing rate	3 m/s
Acceleration	10 m/s ²
Torsion force	± 270 °/m (4,000,000 torsion cycles, max. 25 torsion cycles/min)
Cable weight	23 kg/km
Outer sheath, material	PP-EPDM
Material conductor insulation	PP
Conductor material	Bare Cu litz wires
Insulation resistance	≥ 1 GΩ*km (at 20 °C)
Conductor resistance	78 Ω/km (at 20 °C)
Nominal voltage, cable	≤ 300 V AC
Test voltage, cable	≥ 3000 V AC (Spark test)
Special properties	FDA compliant according to FDA 21 CFR 177.2600
	highly flexible
	Flexible cable conduit capable
Halogen-free	in accordance with DIN VDE 0472 part 815
	in accordance with DIN EN 50267-2-1
Other resistance	Resistant to cold bending and cold impacts According to DIN EN 60811-1-4 (-40 °C)
Ambient temperature (operation)	-40 °C ... 105 °C (cable, fixed installation)
	-25 °C ... 105 °C (cable, flexible installation)

Environmental Product Compliance

China RoHS	Environmentally friendly use period: unlimited = EFUP-e
	No hazardous substances above threshold values

Drawings

Sensor/actuator cable - SAC-4P-M 8MS/ 0,6-600/M 8FR FB - 1406863

Dimensional drawing

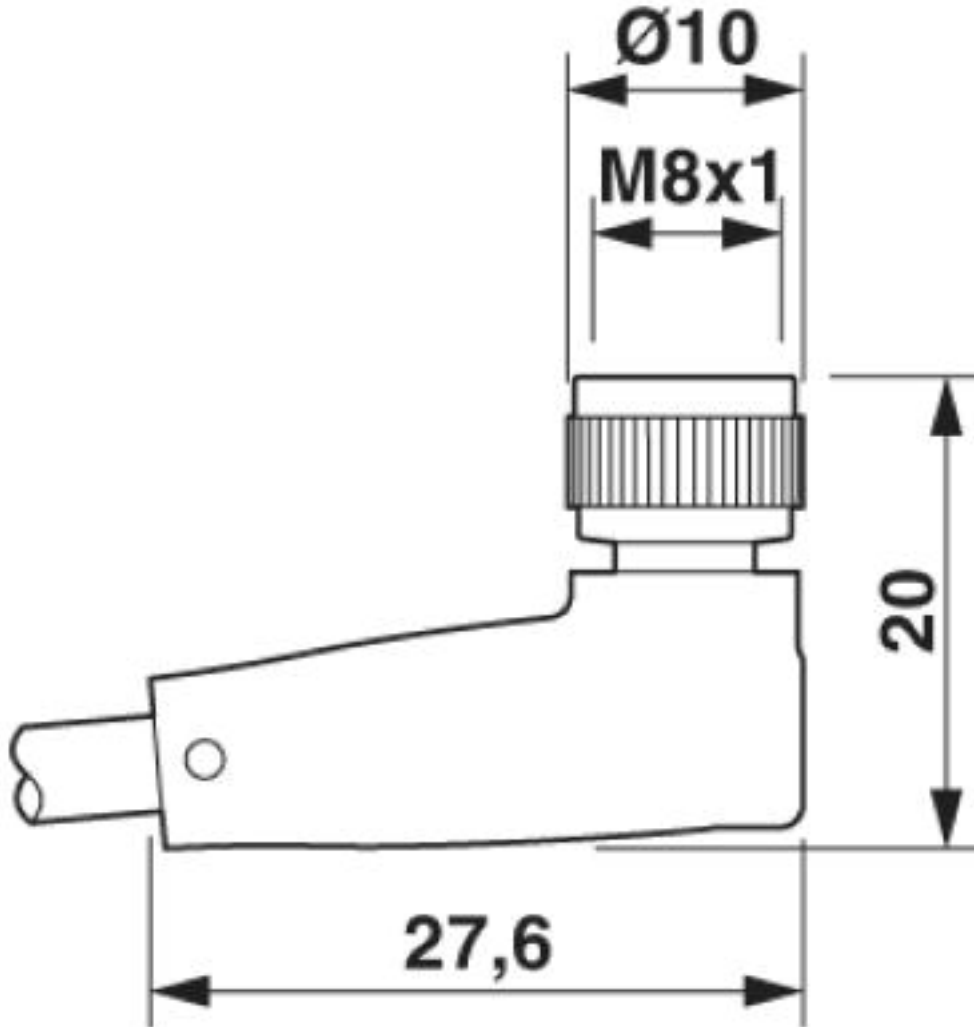

Socket M8 x 1, angled

Dimensional drawing

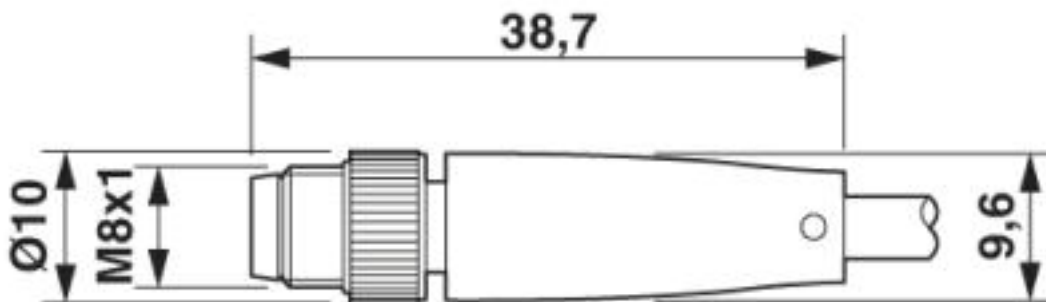

M8 x 1 male plug, straight version

Sensor/actuator cable - SAC-4P-M 8MS/ 0,6-600/M 8FR FB - 1406863

Circuit diagram

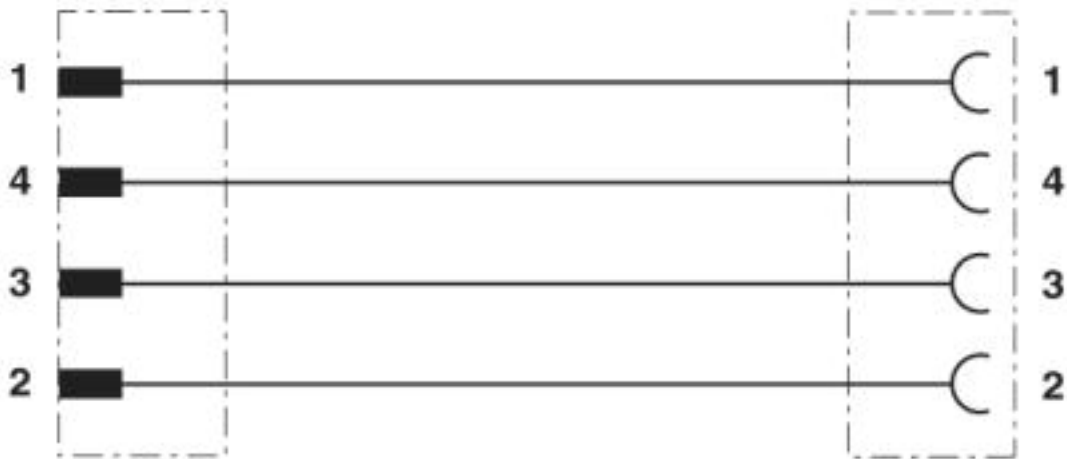

Contact assignment of M8 plugs/sockets

Sensor/actuator cable - SAC-4P-M 8MS/ 0,6-600/M 8FR FB - 1406863

Schematic diagram

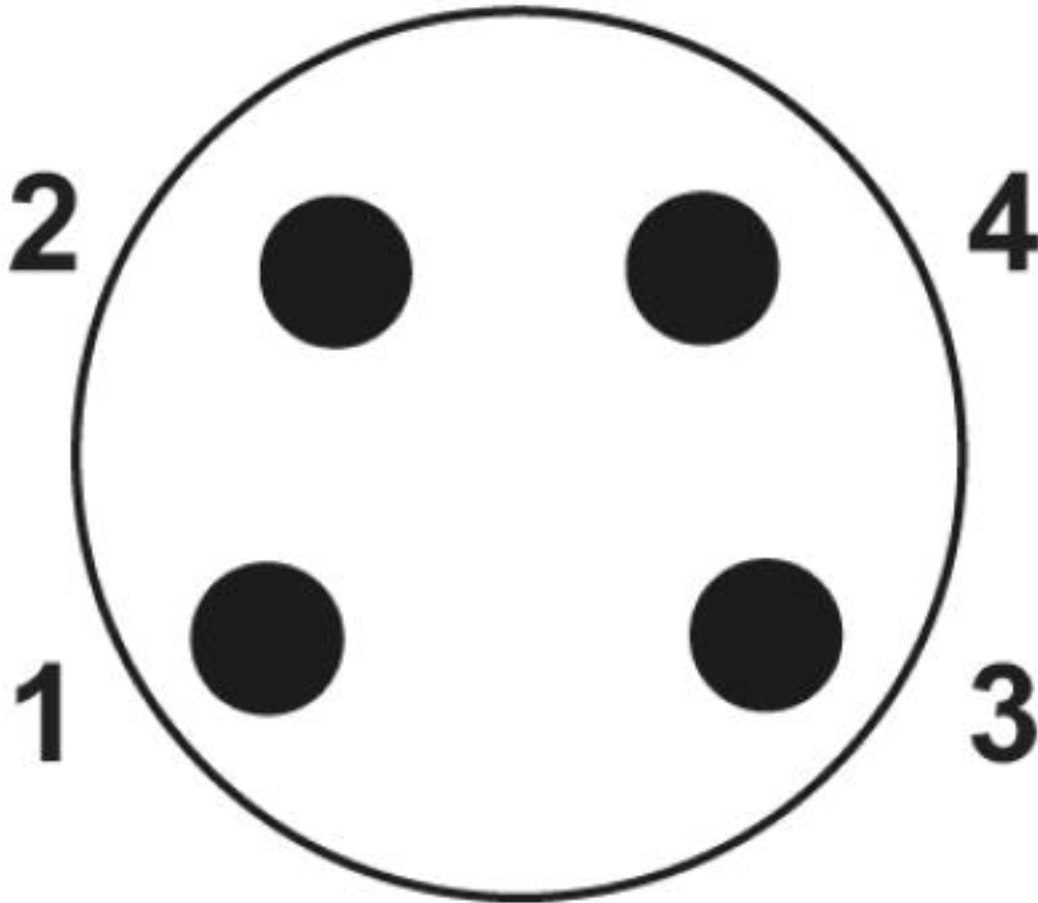

Pin assignment M8 plug, 4-pos., view male side

Sensor/actuator cable - SAC-4P-M 8MS/ 0,6-600/M 8FR FB - 1406863

Schematic diagram

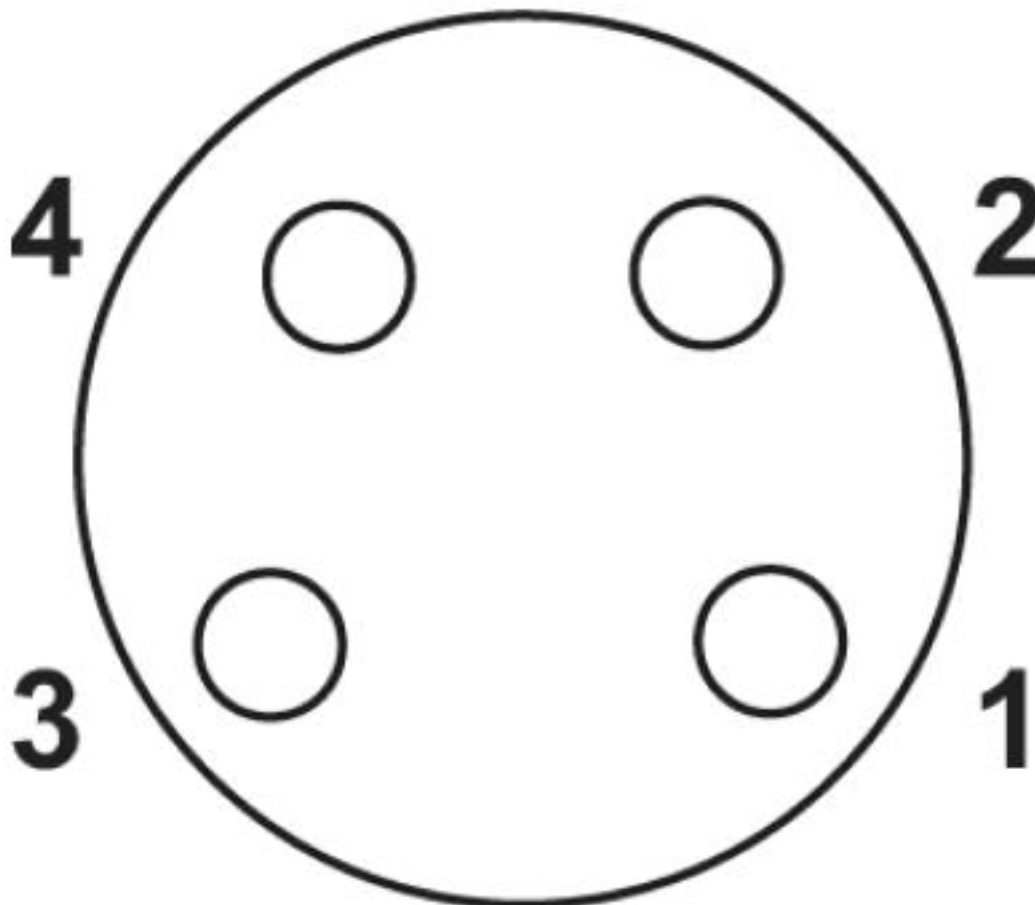

Pin assignment M8 socket, 4-pos., view female side

Sensor/actuator cable - SAC-4P-M 8MS/ 0,6-600/M 8FR FB - 1406863

Cable cross section

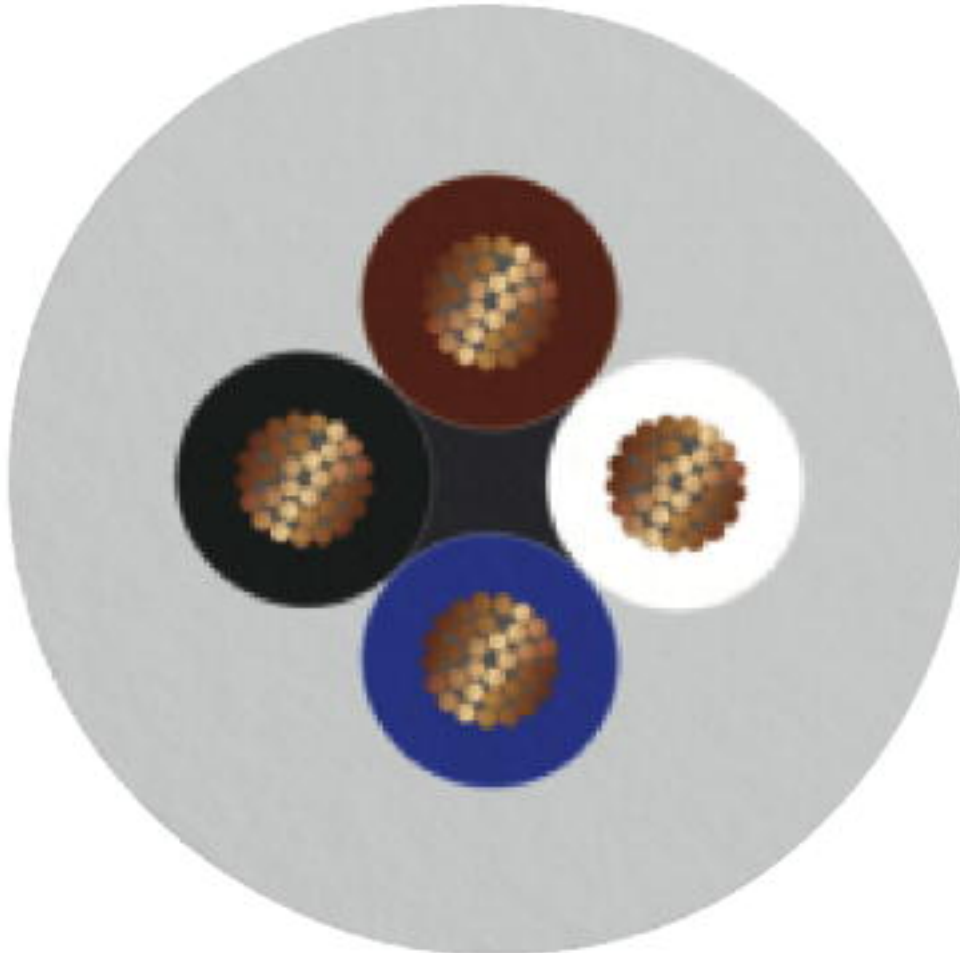

Halogen-free PP gray [600]

Approvals

Approvals

Approvals

EAC

Ex Approvals

Approval details

Sensor/actuator cable - SAC-4P-M 8MS/ 0,6-600/M 8FR FB - 1406863

Approvals

EAC



RU C-
DE.BL08.B.00286

Phoenix Contact 2019 © - all rights reserved
<http://www.phoenixcontact.com>

PHOENIX CONTACT GmbH & Co. KG
Flachsmarktstr. 8
32825 Blomberg
Germany
Tel. +49 5235 300
Fax +49 5235 3 41200
<http://www.phoenixcontact.com>