

TIMI Click DATASHEET

Document Revision: 1.0
Document Date: 28/07/2021

Content subject to change at any time, please refer to
www.breadboardmates.com for the latest revision.

Table of Contents

Document Revision History	3
Hardware Revision History	3
About Breadboard Mates	4
Product Description	5
Product Features	5
Hardware Detail	6
Pin Configuration	6
Hardware Interfaces	7
System Pins	7
Serial Ports – TTL Level Serial	7
HOST/PROG Switch	8
Hardware Requirements	9
Hardware Overview	9
What you will need	9
Optional Hardware	9
Required Software	10
Programming Hardware	11
Programming Hardware - Overview	11
Programming Hardware – Detail	11
Connection to the Host board	12
Hardware Drawing	13
Hardware Schematic	14
Specifications & Ratings	15
Legal Notice	16

Document Revision History

Revision Number	Date	Description
0.1	13/07/2021	Initial Draft
1.0	28/07/2021	Initial Public Release

Hardware Revision History

Revision Number	Date	Description
1.0	04/06/2021	Initial Revision

About Breadboard Mates

Breadboard Mates (aka BBM) is an Australian start-up company and was established in 2020 with the aim to bring breadboard friendly display products to the market, cutting down the time and components required to develop or experiment with electronics.

Hobbyist to Professional, BBM products can be utilised for development or education or anything in between. Development of projects / applications is made incredibly easy with the help of the revolutionary Mates Studio IDE.

The Mates Studio IDE is unlike any other, it offers 4 different programming methods with interchangeable pages and widgets, and helps speed up development for stand alone, host driven or PC tethered applications.

Breadboard Mates is constantly working on new product ideas, so keep a watch on the breadboardmates.com website for new product releases.

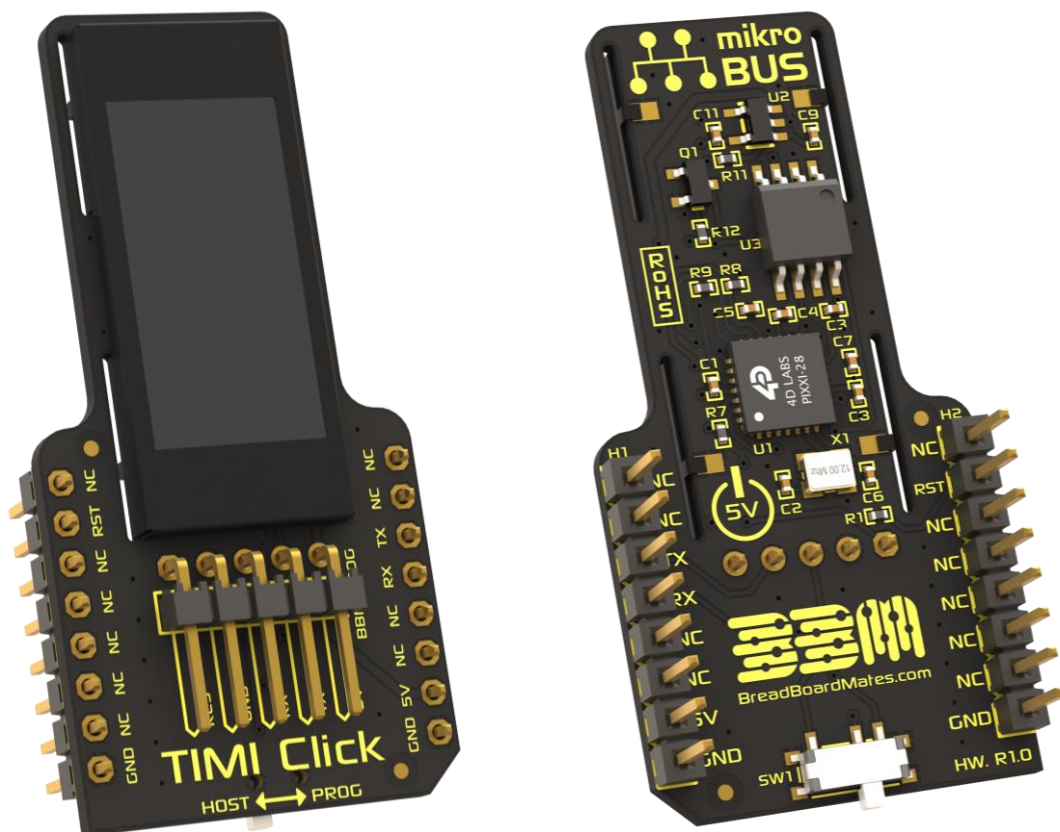

Product Description

TIMI-Click (ref. TIMI Click) is a unique breadboard compatible display development module designed to provide development boards/modules which have a MikroBUS Click socket a simple to interface display solution. TIMI Click is aimed to speed up and reinvent the way electronic testing, development and projects are carried out.

TIMI Click is a 0.96" TFT LCD display module that is driven directly by a PIXXI-28 graphics processor from 4D Labs. It features a MikroBUS interface, designed to attach to development platforms featuring a MikroBUS socket or headers.

The TIMI Click also features a 5-pin programming header, to program its processor using the BBM Programmer, and a selection switch (on the back – accessible from the bottom edge) to switch between device programming mode or connection of the device to the MikroBUS Host.

TIMI Click was created as a flexible design aid, primarily to simulate components readouts and meters, which would otherwise be cumbersome or demanding on hardware resources for breadboard or electronic development. Simulating component readouts allows accelerated development and retains the often-limited GPIO hardware associated with many developments.

TIMI Click was designed for engineers, hobbyists, and students, from beginner to advanced levels, designed to make project development, easier.

Product Features

The TIMI Click connects to the MikroBUS Click interface, utilising primarily the Serial UART of the Click host. It also features a selector switch, which interrupts the Hosts TX signal, to direct the TIMI Click's RX signal to the programming header instead. This allows the TIMI Click to be left connected to the Host board when the TIMI Click is required to be programmed.

The interface to the TIMI Click is a 3.3V level Asynchronous Serial UART and is used to communicate between the Host and the TIMI Click itself. Reset is also connected to the RST of the MikroBUS.

- Powered by 4D Labs Pixxi-28 Graphics Processor
- 160(W)x80(H) resolution TFT LCD, non-touch
- 3.3V (5V tolerant) Serial UART interface, capable 300 to 2187500 Baud
- 16MB of External SPI Flash Memory
- 32KB of Processor Flash Memory
- 14KB of Processor SRAM for User Variables
- Single supply 5V power input (*3.3V possible - See 'System Pins' Section)
- Standard 0.1" (2.54mm) pitch male pin headers, MikroBUS compatible
- RoHS and REACH compliant
- PCB is UL 94V-0 Flammability Rated
- Weight approx. 6.0 grams

Hardware Detail

TIMI Click utilises the MikroBUS interface, which is a unique interface pinout designed to be simple and easy to use.

The MikroBUS is made up of 2 rows of 8 pins, 0.1" (2.54mm) pitch, spaced 0.9" (22.86mm) apart. Please refer to the Mikroelektronika MikroBUS Standard.

The TIMI Click can be orientated in any of its 4 positions, Portrait, Landscape, Portrait Reversed and Landscape Reversed, and is defined using the Mates Studio IDE.

Pin Configuration

The TIMI Click has 16 physical pins, 8 on each side of the MikroBUS interface. The TIMI Click does not utilise all the pins in the MikroBUS however.

MikroBUS Pinout			
Header / Pin	Symbol	I/O Type	Description
Header1 - 1	GND	Power	Module / System GND
Header1 - 2	5V	Power	Module 5V Input, Main Power
Header1 - 3	NC	-	Not Connected / Used
Header1 - 4	NC	-	Not Connected / Used
Header1 - 5	RX	I	Asynchronous Serial UART Receive Pin (3.3V, 5V Tolerant)
Header1 - 6	TX	O	Asynchronous Serial UART Transmit Pin (3.3V Level)
Header1 - 7	NC	-	Not Connected / Used
Header1 - 8	NC	-	Not Connected / Used
Header2 - 1	GND	Power	Module / System GND
Header2 - 2	NC	-	Not Connected / Used
Header2 - 3	NC	-	Not Connected / Used
Header2 - 4	NC	-	Not Connected / Used
Header2 - 5	NC	-	Not Connected / Used
Header2 - 6	NC	-	Not Connected / Used
Header2 - 7	RESET	I	Reset (Series 680R Resistor), for resetting the TIMI Click
Header2 - 8	NC	-	Not Connected / Used

For more detail on the MikroBUS pinout and specification, please refer to the Mikroelektronika website, and the MikroBUS Standard documentation, or the product documentation for the Host device being used which features the MikroBUS socket.

Hardware Interfaces

The TIMI Click connects to the MikroBUS Click interface and utilises the Serial UART of the Host device.

System Pins

+5V (Device Supply Voltage)

Display supply voltage pin. This pin supplies the TIMI Click with 5VDC from the Host board.

GND (Module Ground)

Device ground pin.

TX (Serial UART Transmit)

TX of the TIMI Click connects to RX of the Host board, this is the 3.3V Asynchronous Serial UART Transmit for communications between the two devices.

RX (Serial UART Receive)

RX of the TIMI Click connects to TX of the Host board, this is the 3.3V Asynchronous Serial UART Receive for communications between the two devices. This pin is also 5V tolerant, so can be interfaced to 5V UART devices.

RESET (Module Master Reset)

This pin is connected to the Host via a 680ohm resistor to the RST pin on the MikroBUS, making it possible for the Host to initiate a reset as required. It is also connected to the BBM-Prog header (bypassing the resistor), for programming the 4D Labs processor using the Mates Studio IDE, based on the position of the switch.

NC (Not connected)

These pins are not connected or used on the Interface.

Serial Ports – TTL Level Serial

The PIXXI-28 Processor has a single hardware asynchronous serial port with fixed pins TX/RX. The PIXXI-28's serial port can be used to communicate with external serial devices and is also used for programming the PIXXI-28 itself.

The primary features are:

Full-Duplex 8-bit data transmission and reception.

Data format: 8-bits, No Parity, 1 Stop bit.

Independent Baud rates from 300 baud up to 2187500 baud.

This serial UART is also the programming interface for User program downloads. Once the compiled application is downloaded and the user code starts executing, the serial port is then available to the user application.

Note: The serial UART output at the level of TTL 3.3V, however is 5V tolerant on the RX pin, so can accept communications from 5V devices.

HOST/PROG Switch

The HOST/PROG selection switch is used to switch the RX signal which comes from the TIMI Click, between the Host's TX, and the BBM-PROG headers TX. This allows the User to select if the TIMI Click is being programmed by the BBM-PROG header, or if its connected to the Host, making it possible to program the TIMI Click without having to unplug it from the MikroBUS socket.

When you want communications to be between the Host and the TIMI Click, the switch should be on **HOST**.

When you want the communications to be between the BBM-PROG header and the TIMI Click, the switch should be on **PROG**.

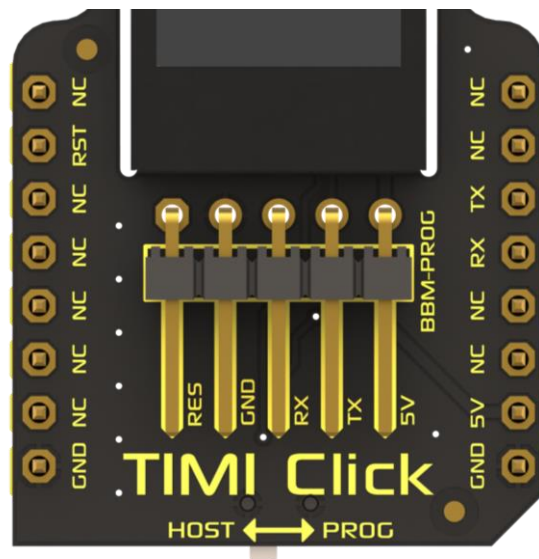

Hardware Requirements

Hardware Overview

TIMI Click is designed to be used in several ways, but the most basic configurations can be achieved with a TIMI Click module and a BBM-Programmer, connected to your PC in a tethered configuration (See Programming Hardware section).

What you will need

- TIMI Click Module
- BBM-Programmer
- MicroUSB Cable (Standard Type A USB to microUSB – Not included)
- Windows PC/Laptop running Windows 7 or higher, x86 or x64. ARM is currently not supported at this time.

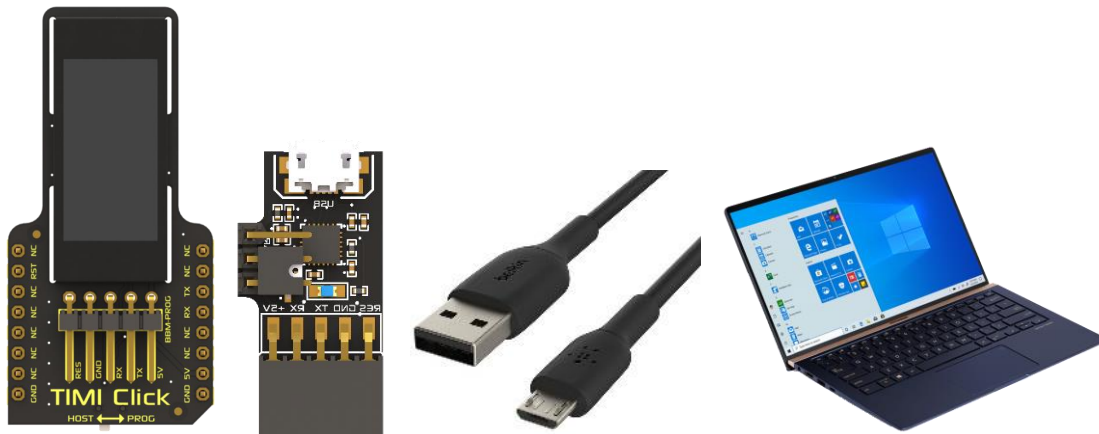

The BBM-Programmer does not come with the microUSB cable, this can be purchased from virtually any hardware/computer store.

Currently Microsoft Windows is the only supported Operating System for Mates Studio. Announcements will be made when other OS's will become supported.

Optional Hardware

Typically, the TIMI Click would be used with a Host board featuring a MikroBUS Click socket. This is not strictly required to use the TIMI Click, however is the intended interface for the TIMI Click.

There are a huge variety of MikroBUS compatible development boards, featuring a MikroBUS Click socket. Select the most appropriate host board for your requirements, and the TIMI Click should be able to connect to it without a problem.

Not all Host platforms will have demo software or libraries available however, but since the TIMI Click interface is a simple UART, writing of code should be a simple task using the documentation provided on the Breadboard Mates website.

Required Software

All software development for the TIMI Click module utilises the Mates Studio IDE.



Please download the latest version of Mates Studio from the breadboardmates.com website.

Details specific about the Mates Studio IDE can be found in the Mates Studio IDE documentation, available from our website.

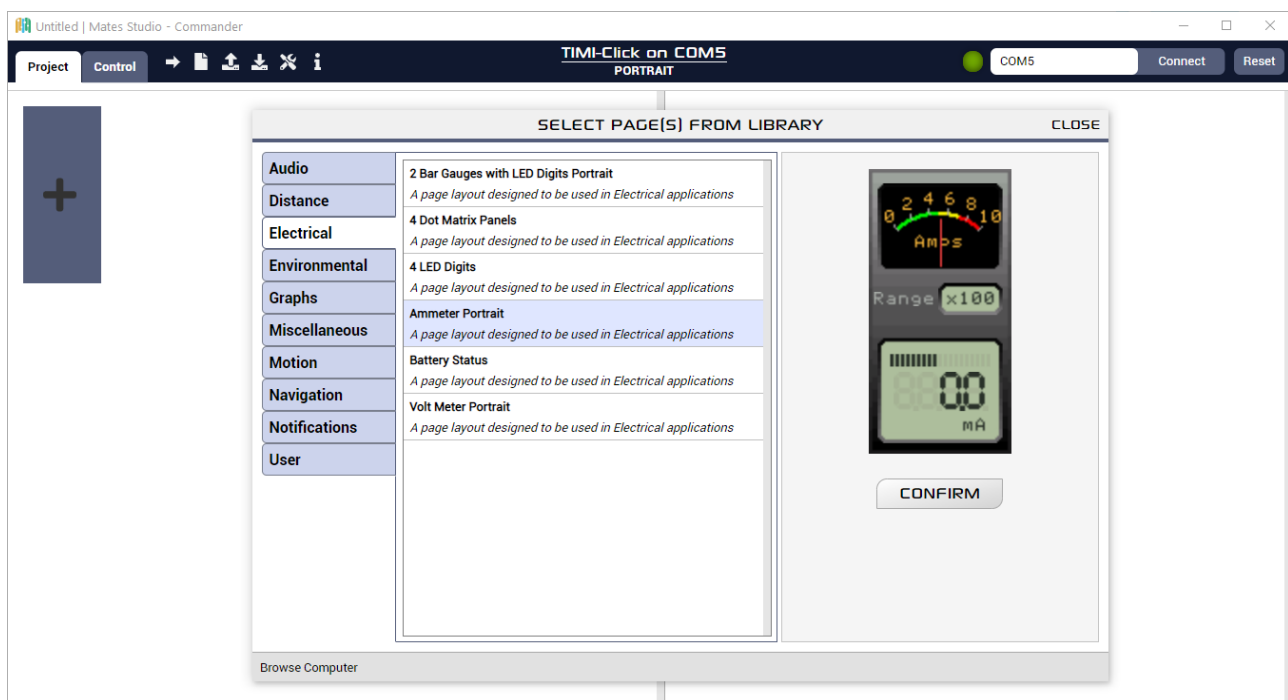

Programming Hardware

Programming Hardware - Overview

TIMI Click utilises a USB to Serial programmer for application and firmware updates, which programs both the Processor Flash memory, along with the on-board SPI Flash memory.

The Programmer, dubbed BBM-Prog, is the official BBM Programmer and can also be used for testing and debugging of TIMI Click applications using the Mates Studio IDE.

Programming Hardware – Detail

The BBM-PROG utilises the Silicon Labs CP2104 USB to UART bridge, and uses the TIMI Click's Serial UART to load applications, firmware/PmmC and media content.

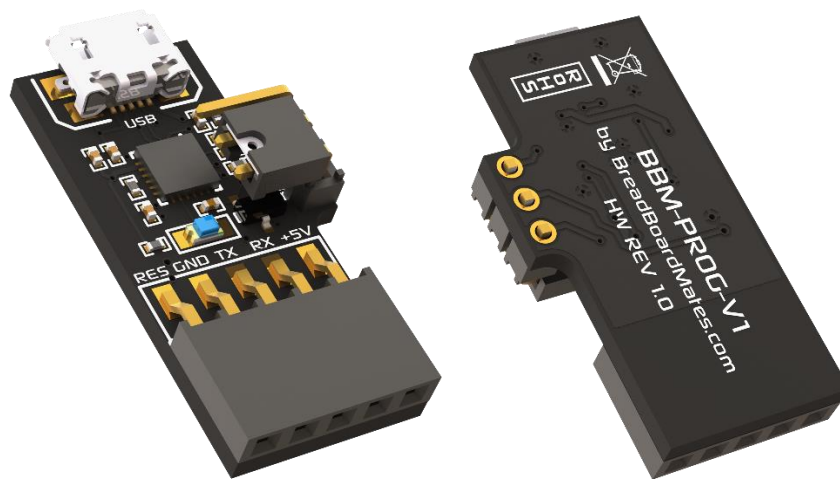

The BBM-PROG features a 3-pin jumper with shunt, which is present to change the way the programmer handles the Reset line, utilised by TIMI and other devices.

TIMI Click requires the jumper to be positioned like the image above, closest to the 5-way female header. This makes the programmer compatible with programming the 4D Labs Pixxi-28 processor.

If the jumper is placed on the 2 pins closest to the USB connector, this will make the programmer compatible with programming Atmel chips, such as is used on many of the Arduino boards, or barebone chips. This may also be compatible with other microcontrollers too.

Connection to the Host board

The TIMI Click connects to the Host directly using the MikroBUS Click interface.

The TIMI Click's male pin headers connect to the Hosts Click female headers / socket. This is compatible with both traditional Female Click headers, and the newer MikroBUS proprietary Click socket which is found on newer boards.

To illustrate, here is a STM32 M4 Clicker development board from Mikroelektronika, with the TIMI Click connected.

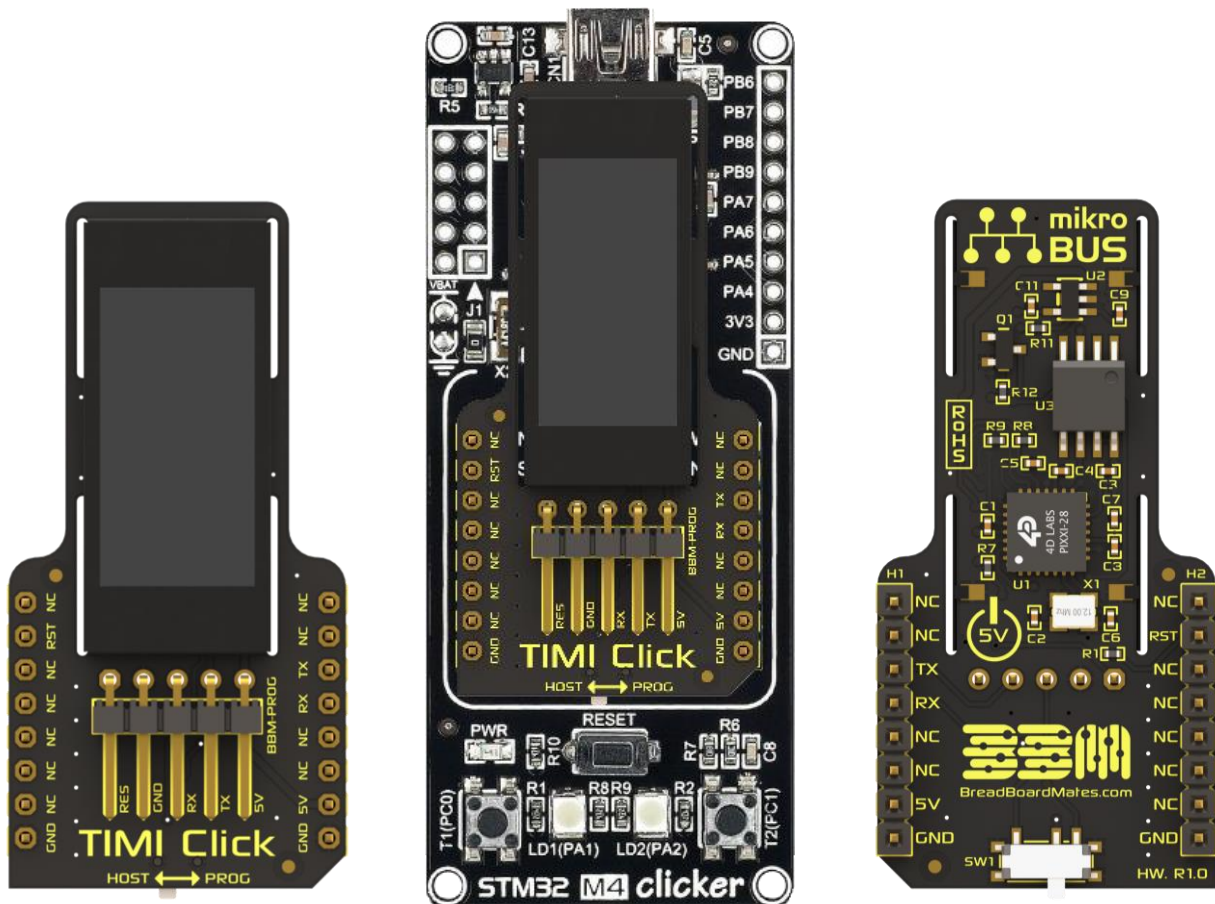

Front View

Connected to M4 Clicker

Back View

Hardware Drawing

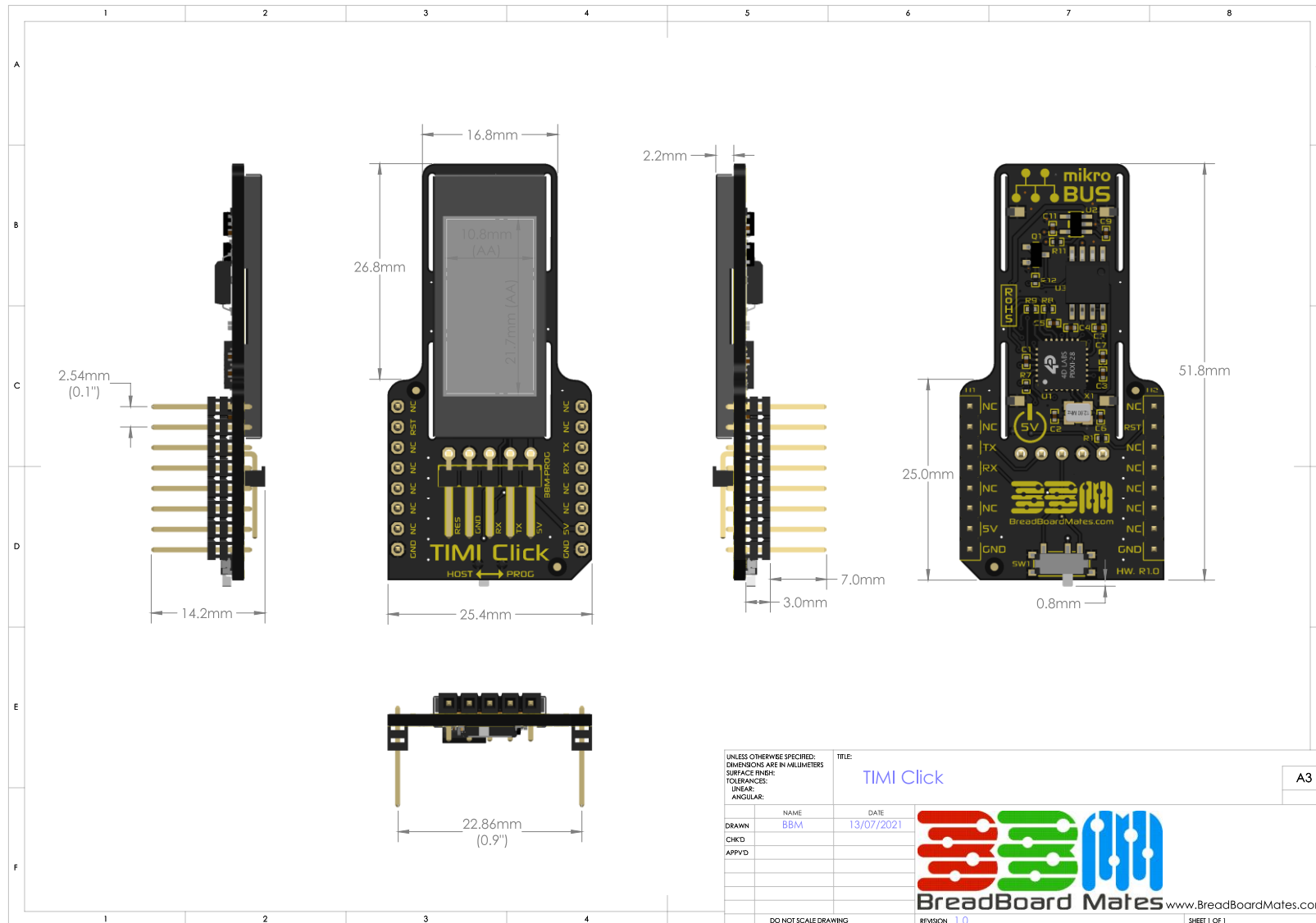

Hardware Schematic

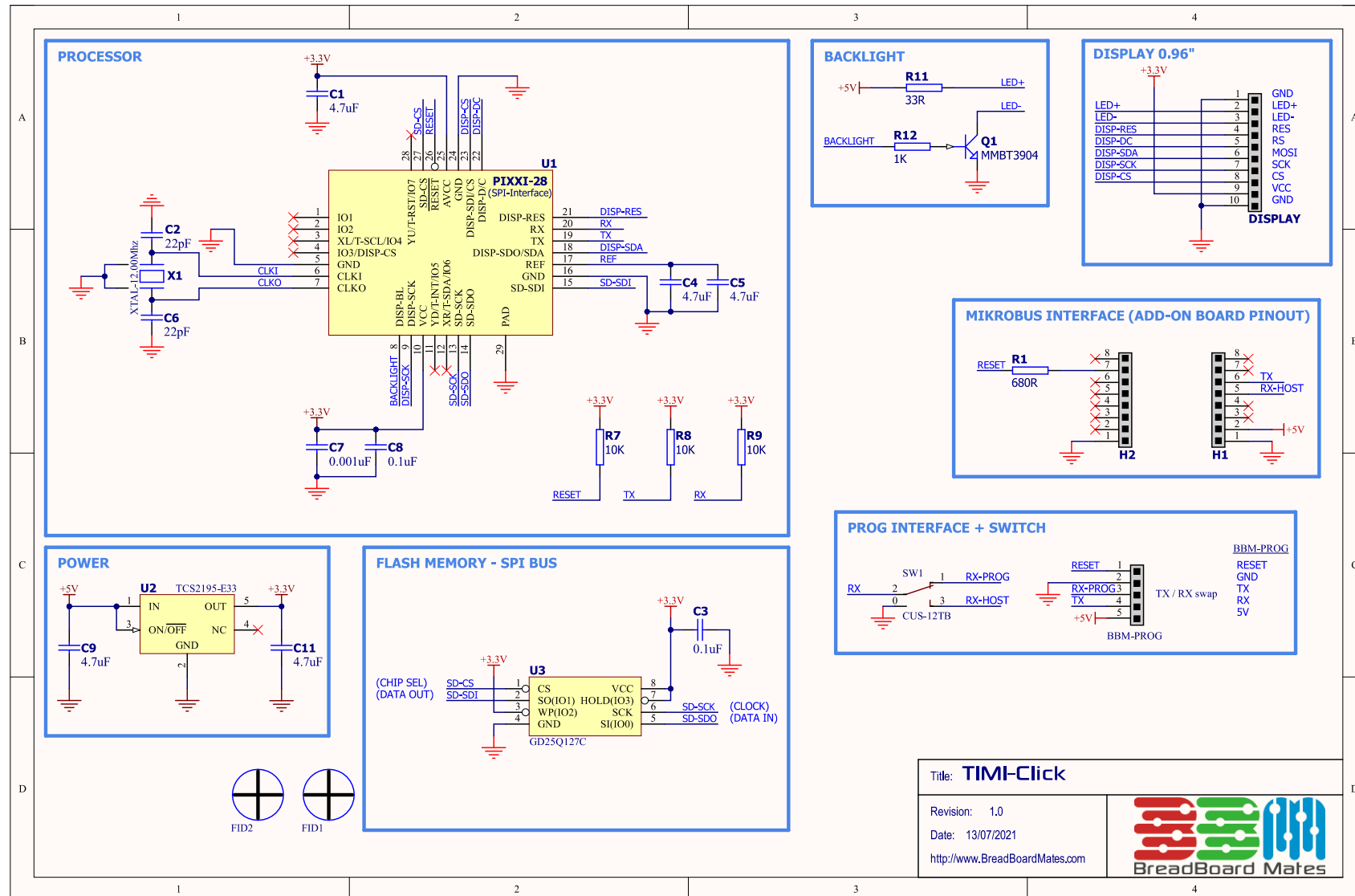

Specifications & Ratings

RECOMMENDED OPERATING CONDITIONS					
Parameter	Conditions / Information	Min	Typ	Max	Units
Operating Temperature		-20	--	+70	°C
Storage Temperature		-30	--	+80	°C
Humidity (RH)	Max 60°C	--	--	90%	RH
Supply Voltage (VCC)	Stable external supply required	4.0	5.0	5.5	V
Processor voltage (VP)		--	3.3	--	V
Input Low Voltage (VIL)	all pins	GND	--	0.2VP	V
Input High Voltage (VIH)	non 5V tolerant pins	0.8VP	--	3.3	V
Input High Voltage (VIH)	5V Tolerant Pins, (RX pin)	0.8VP	--	VCC	V
Reset Pulse	External Open Collector (RESET pin)	1.3	--	--	µs
Operational Delay	Power-Up or External Reset	500	--	3000	Ms

OPERATING CHARACTERISTICS					
Parameter	Conditions / Information	Min	Typ	Max	Units
Supply Current (ICC)	5V Supply – Normal Operation	--	90	--	mA
	5V Supply – Sleep Mode	--	3	--	mA
	5V Supply – Deep Sleep Mode	--	2	--	mA
Display Endurance	Hours of operation, measured to when display is 50% original brightness	30000	--	--	H

LCD DISPLAY INFORMATION		
Parameter	Conditions / Information	Specification
Display Type		TFT IPS LCD
Display Size		0.96" Diagonal
Display Resolution		160x80 pixels
Display Brightness	5V Supply	120 cd/m2 (typical)
Display Contrast Ratio		800:1 (typical)
Display Viewing Angles	Above Centre	80 Degrees
	Below Centre	80 Degrees
	Left of Centre	80 Degrees
	Right of Centre	80 Degrees
Display Viewing Direction		ALL (IPS Display)
Display Backlighting	White LED Backlighting	1 LED
Pixel Pitch		0.135 x 0.135mm (Square pixels)
Pixel Density	Number of pixels in 1 row in 25.4mm	187 DPI/PPI

Legal Notice

Proprietary Information

The information contained in this document is the property of 'Breadboard Mates' and may be the subject of patents pending or granted and must not be copied or disclosed without prior written permission.

Breadboard Mates endeavours to ensure that the information in this document is correct and fairly stated but does not accept liability for any error or omission. The development of Breadboard Mates products and services are continuous and published information may not be up to date. It is important to check the current position with Breadboard Mates. Breadboard Mates reserves the right to modify, update or makes changes to Specifications or written material without prior notice at any time.

All trademarks belong to their respective owners and are recognised and acknowledged.

Disclaimer of Warranties & Limitation of Liability

Breadboard Mates makes no warranty, either expressed or implied with respect to any product, and specifically disclaims all other warranties, including, without limitation, warranties for merchantability, non-infringement, and fitness for any particular purpose.

Information contained in this publication regarding device applications and the like is provided only for your convenience and may be superseded by updates. It is your responsibility to ensure that your application meets with your specifications.

Images and graphics used throughout this document are for illustrative purposes only. All images and graphics used are possible to be displayed on the Breadboard Mates range of products, however the quality may vary.

In no event shall Breadboard Mates be liable to the buyer or to any third party for any indirect, incidental, special, consequential, punitive, or exemplary damages (including without limitation lost profits, lost savings, or loss of business opportunity) arising out of or relating to any product or service provided or to be provided by Breadboard Mates, or the use or inability to use the same, even if Breadboard Mates has been advised of the possibility of such damages.

Breadboard Mates products are not fault tolerant nor designed, manufactured or intended for use or resale as on line control equipment in hazardous environments requiring fail – safe performance, such as in the operation of nuclear facilities, aircraft navigation or communication systems, air traffic control, direct life support machines or weapons systems in which the failure of the product could lead directly to death, personal injury or severe physical or environmental damage ('High Risk Activities'). Breadboard Mates and its suppliers specifically disclaim any expressed or implied warranty of fitness for High-Risk Activities.

Use of Breadboard Mates products and devices in 'High Risk Activities' and in any other application is entirely at the buyer's risk, and the buyer agrees to defend, indemnify, and hold harmless Breadboard Mates from any-and-all damages, claims, suits, or expenses resulting from such use. No licenses are conveyed, implicitly or otherwise, under any Breadboard Mates intellectual property rights.