

4 CKT SHOWN

NOTES:

1) MATERIAL:

- 225S = NYLON 6, UL94V-2, GLOW WIRE MATERIAL COLOR: BLACK
- 225NS = NYLON 6, UL94V-2, GLOW WIRE MATERIAL COLOR: NATURAL
- 250RS = NYLON 6/6, UL94V-0, GLOW WIRE MATERIAL COLOR: RED
- 250GS = NYLON 6/6, UL94V-0, GLOW WIRE MATERIAL COLOR: GREEN
- 250BS = NYLON 6/6, UL94V-0, GLOW WIRE MATERIAL COLOR: BLUE
- 250WS = NYLON 6/6, UL94V-0, GLOW WIRE MATERIAL COLOR: NATURAL

2) FINISH: NOT APPLICABLE

3) PRODUCT SPECIFICATION: PS-5556-001

4) PACKAGING: BULK

5) PART MATES WITH MOLEX PLUG #46993 AND HEADERS #172447, #172448.

6) PART TO BE USED WITH MOLEX FEMALE TERMINAL #5556.

7) PART IS NOT DESIGNED FOR CURRENT SHARING.

8) CONNECTORS ARE NOT TO BE MATED OR UNMATED WHILE CIRCUITS ARE LIVE.

9) WIRES ARE TO BE DRESSED IN SUCH A MANNER TO ALLOW THE TERMINALS TO FLOAT FREELY IN THE POCKET.

10) PART CONFORMS TO CLASS "B" REQUIREMENTS OF COSMETIC SPECIFICATION PS-45499-002 WITH THE EXCEPTION OF DISCOLORATION, FLASH AND SINK MEET

△ CLASS "C" REQUIREMENTS.
TO BE MEASURED AT SURFACE Z

12) TEXT ON PART IS FOR REFERENCE ONLY. TEXT AND TEXT LOCATION MAY VARY DEPENDING ON PART NUMBER AND/OR TOOL.

13) APPLICATION SPECIFICATION :469920000-AS.

14) BUBBLE IS ACCEPTABLE ON LATCH AREA.

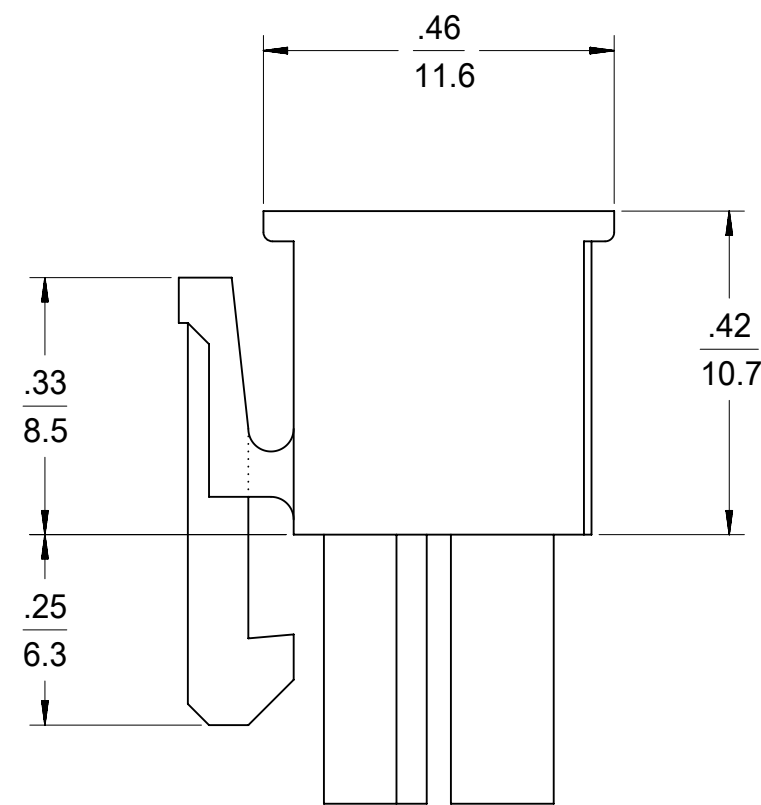
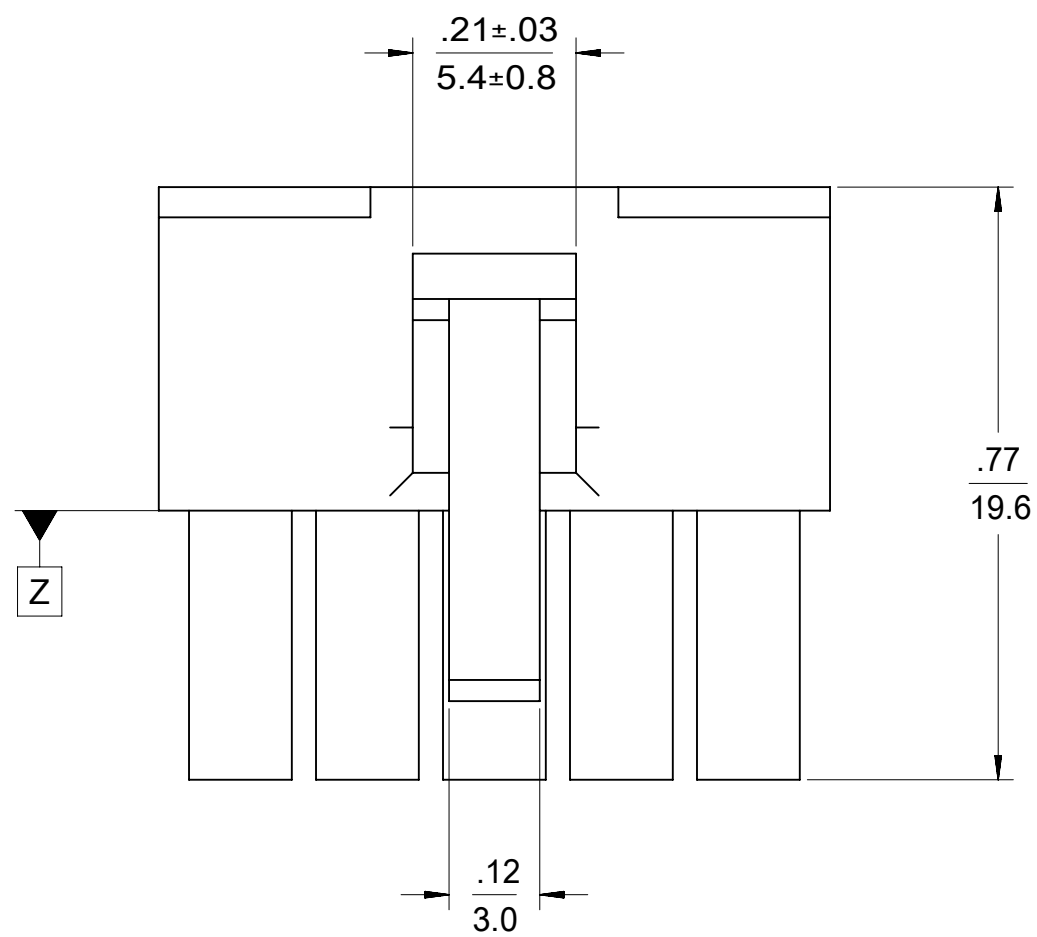

4-24 CKT

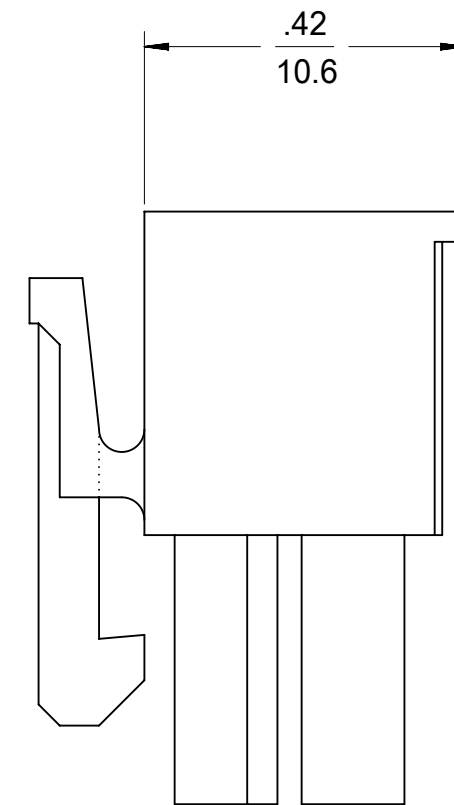

2 CKT ONLY

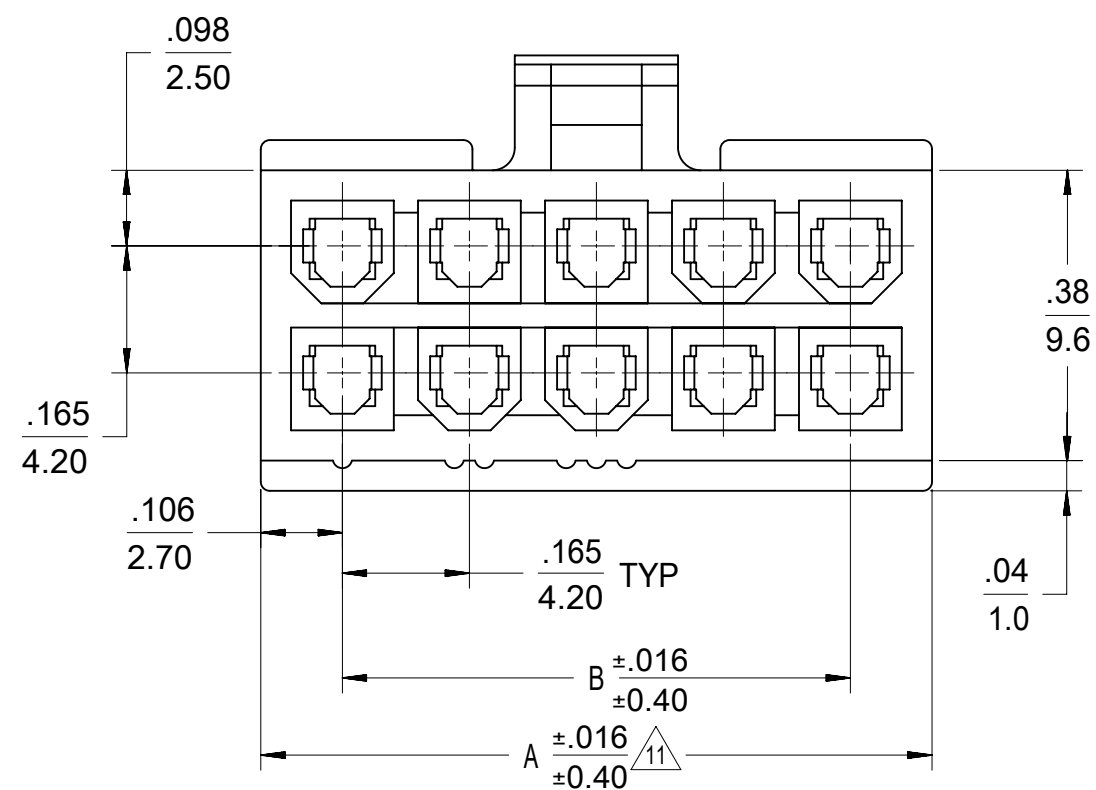

LEGEND

- 46992 -*** 0
- CIRCUIT SIZE
- MATERIAL (SEE NOTE 1)
 0 = 225NS
 1 = 225S
 2 = 250RS
 3 = 250GS
 4 = 250BS
 5 = 250WS
- CONFIGURATION
 DUAL ROW

THIS DRAWING CONTAINS INFORMATION THAT IS PROPRIETARY TO MOLEX ELECTRONIC TECHNOLOGIES, LLC AND SHOULD NOT BE USED WITHOUT WRITTEN PERMISSION									
DIMENSION UNITS		SCALE		CURRENT REV DESC:					
mm		NTS		EC NO: 719028					
GENERAL TOLERANCES (UNLESS SPECIFIED)				DRWN: JERRYW8				2022/08/23	
4 PLACES		±		CHK'D: XQZHANG				2022/09/01	
3 PLACES		±		APPR: XQZHANG				2022/09/01	
2 PLACES		± 0.25		INITIAL REVISION:				DOCUMENT NUMBER	
1 PLACE		± 0.38		DRWN: NNGUYEN				2013/04/12	
0 PLACES		±		APPR: FSMITH				2014/05/16	
ANGULAR TOL		± 3.0 °		THIRD ANGLE PROJECTION		DRAWING		SERIES	
DRAFT WHERE APPLICABLE MUST REMAIN WITHIN DIMENSIONS						C-SIZE		46992	
MATERIAL NUMBER				CUSTOMER				SHEET NUMBER	
SEE TABLE				GENERAL MARKET				1 OF 2	

MINIFIT JR
 RECEPTACLE HOUSING DUAL ROW, 2-24 CKT

PRODUCT CUSTOMER DRAWING

SD-46992-0000

PSD 000 A9



2 CKT.



14 CKT.

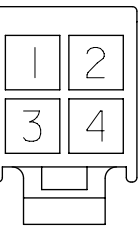

4 CKT.

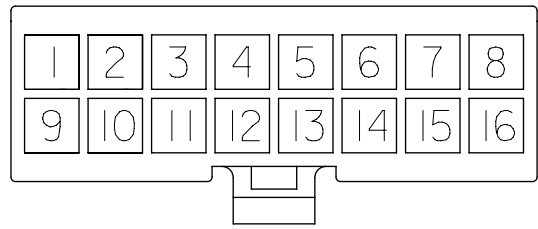

16 CKT.

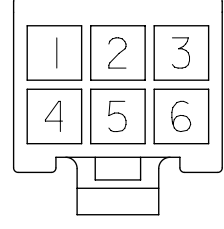

6 CKT.

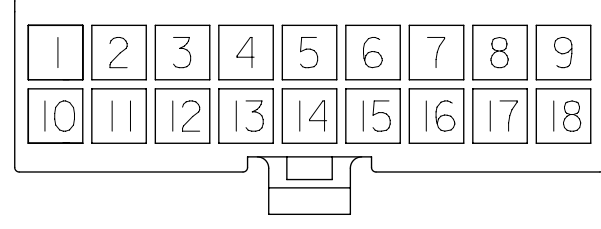

18 CKT.

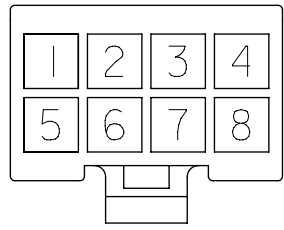

8 CKT.

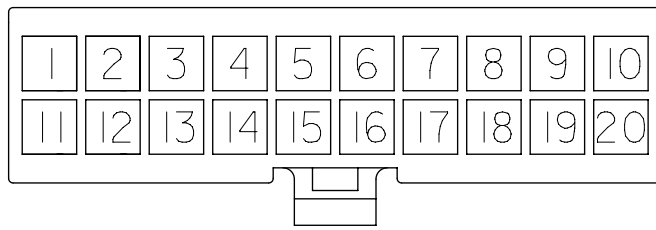

20 CKT.

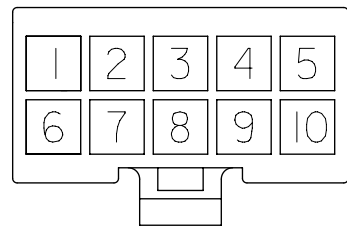

10 CKT.

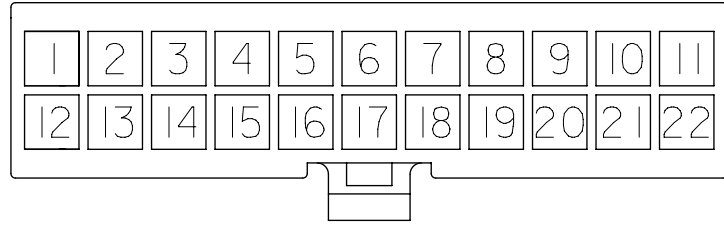

22 CKT.

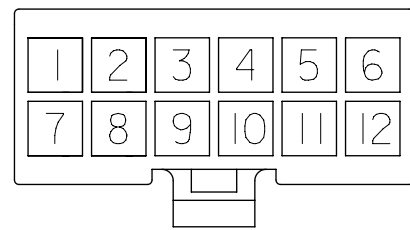

12 CKT.

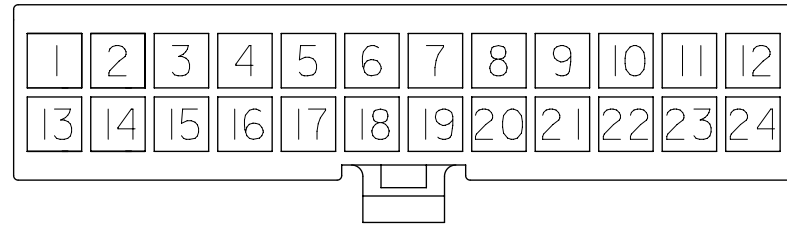

24 CKT.

**CIRCUIT SIZE LAYOUT
(NOT TO SCALE)**

PART NUMBER	CKT SIZE	DIM "A"	DIM "B"	MATERIAL CODE & COLOR
46992-0240	02	.21/5.40	--	250BS BLUE (V0)
46992-0440	04	.38/9.60	.165/4.20	
46992-0640	06	.54/13.8	.331/8.40	
46992-0840	08	.71/18.0	.496/12.60	
46992-1040	10	.87/22.2	.661/16.8	
46992-1240	12	1.04/26.4	.827/21.00	
46992-0250	02	.21/5.40	--	250WS NATURAL (V0)
46992-0450	04	.38/9.60	.165/4.20	
46992-0650	06	.54/13.8	.331/8.40	
46992-0850	08	.71/18.0	.496/12.60	
46992-1050	10	.87/22.2	.661/16.8	
46992-1250	12	1.04/26.4	.827/21.00	

PART NUMBER	CKT SIZE	DIM "A"	DIM "B"	MATERIAL CODE & COLOR
46992-0200	02	.21/5.40	--	225NS NATURAL (V2)
46992-0400	04	.38/9.60	.165/4.20	
46992-0600	06	.54/13.8	.331/8.40	
46992-0800	08	.71/18.0	.496/12.60	
46992-1000	10	.87/22.2	.661/16.8	
46992-1200	12	1.04/26.4	.827/21.00	
46992-1400	14	1.21 / 30.6	.992/25.20	
46992-1600	16	1.37 / 34.8	1.158/29.40	
46992-1800	18	1.54 / 39.0	1.323/33.60	
46992-2000	X 20	1.70 / 43.2	1.488/37.80	
46992-2200	X 22	1.87 / 47.4	1.654/42.00	
46992-2400	X 24	2.03 / 51.6	1.819/46.20	

46992-0210	02	.21/5.40	--	225S BLACK (V2)
46992-0410	04	.38/9.60	.165/4.20	
46992-0610	06	.54/13.8	.331/8.40	
46992-0810	08	.71/18.0	.496/12.60	
46992-1010	10	.87/22.2	.661/16.8	
46992-1210	12	1.04/26.4	.827/21.00	
46992-1410	14	1.21 / 30.6	.992/25.20	
46992-1610	16	1.37 / 34.8	1.158/29.40	
46992-1810	18	1.54 / 39.0	1.323/33.60	
46992-2010	X 20	1.70 / 43.2	1.488/37.80	
46992-2210	X 22	1.87 / 47.4	1.654/42.00	
46992-2410	24	2.03 / 51.6	1.819/46.20	

46992-0220	02	.21/5.40	--	250RS RED (V0)
46992-0420	04	.38/9.60	.165/4.20	
46992-0620	06	.54/13.8	.331/8.40	
46992-0820	08	.71/18.0	.496/12.60	
46992-1020	10	.87/22.2	.661/16.8	
46992-1220	12	1.04/26.4	.827/21.00	

46992-0230	02	.21/5.40	--	250GS GREEN (V0)
46992-0430	04	.38/9.60	.165/4.20	
46992-0630	06	.54/13.8	.331/8.40	
46992-0830	08	.71/18.0	.496/12.60	
46992-1030	10	.87/22.2	.661/16.8	
46992-1230	12	1.04/26.4	.827/21.00	

X = NOT TOOLED

THIS DRAWING CONTAINS INFORMATION THAT IS PROPRIETARY TO MOLEX ELECTRONIC TECHNOLOGIES, LLC AND SHOULD NOT BE USED WITHOUT WRITTEN PERMISSION

DIMENSION UNITS		SCALE		CURRENT REV. DESC.					
mm		NTS							
GENERAL TOLERANCES (UNLESS SPECIFIED)						MINIFIT JR RECEPTACLE HOUSING DUAL ROW, 2-24 CKT PRODUCT CUSTOMER DRAWING DOCUMENT NUMBER: SD-46992-0000 DOC TYPE: PSD DOC PART: 000 REVISION: A9 MATERIAL NUMBER: SEE TABLE CUSTOMER: GENERAL MARKET SHEET NUMBER: 2 OF 2			
		MM	INCH						
4 PLACES	±		±						
3 PLACES	±		± 0.01						
2 PLACES	±	0.25	± 0.015						
1 PLACE	±	0.38	±						
0 PLACES	±		±						
ANGULAR TOL		± 3.0 °							
DRAFT WHERE APPLICABLE MUST REMAIN WITHIN DIMENSIONS		THIRD ANGLE PROJECTION		DRAWING SERIES					
				C-SIZE 46992					

EC NO: 719028
 DRWN: JERRYW8 2022/08/23
 CHK'D: XQZHANG 2022/09/01
 APPR: XQZHANG 2022/09/01
 INITIAL REVISION:
 DRWN: NNGUYEN 2013/04/12
 APPR: FSMITH 2014/05/16