

RECOMENDED P.C.B HOLE LAYOUT

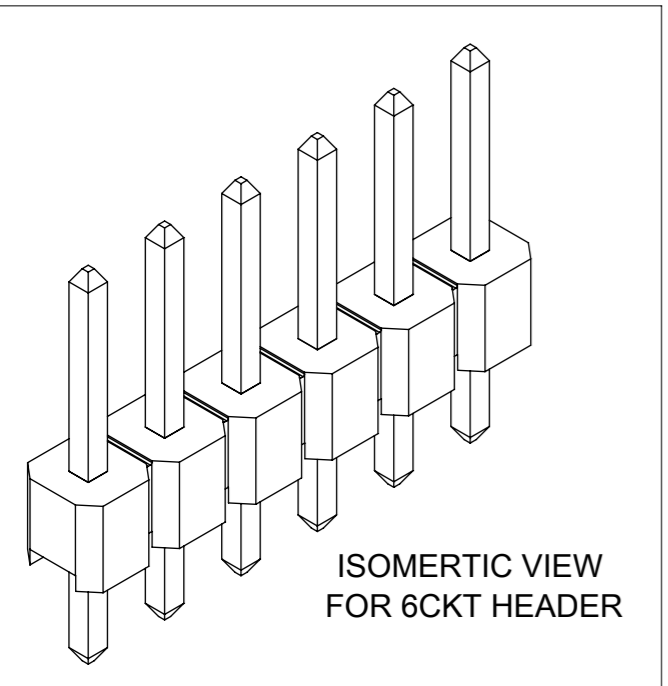
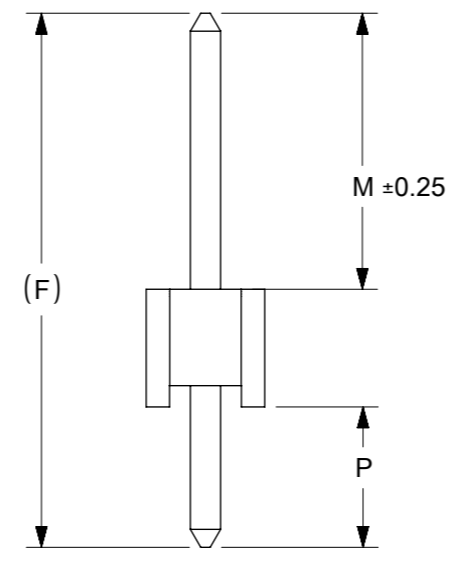
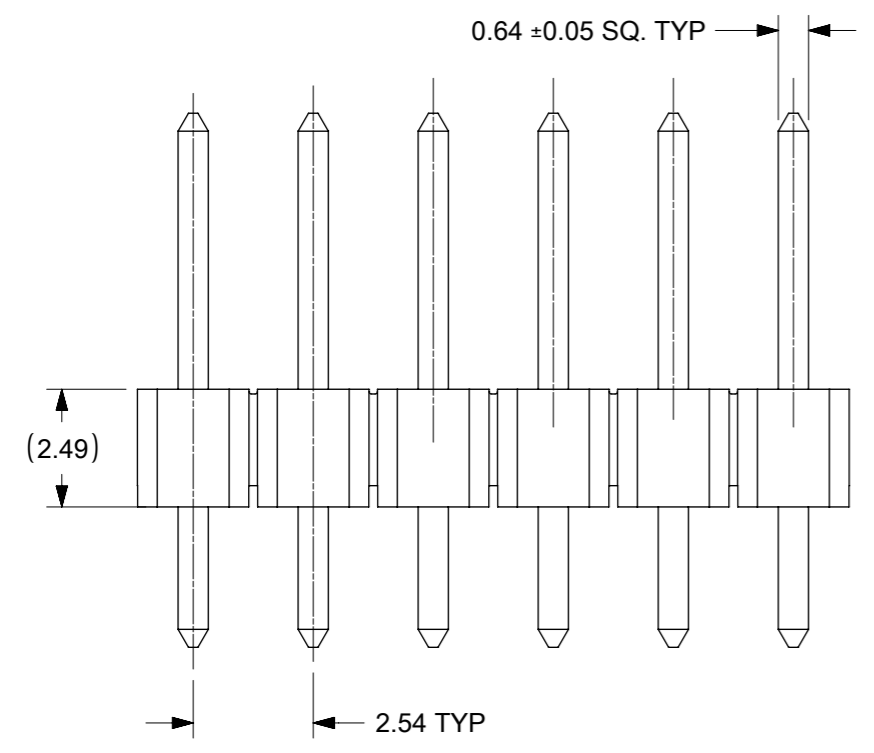

ISOMERTIC VIEW FOR 6CKT HEADER

NOTES

1. MATERIAL:
HSG: NYLON, GLASS-FILLED, UL94V-0 COLOR: BLACK
PIN: 0.64MM SQ, COPPER ALLOY
2. PLATING TYPE:
 - (1) GOLD FLASH OVER
1.270µm MIN. NICKEL OVERALL.
 - (2) GOLD FLASH ON CONTACT AND
1.905µm MIN. TIN ON SOLDERTAIL OVER
1.270µm MIN. NICKEL OVERALL.
 - (3) 0.254µm MIN. GOLD PLATE ON CONTACT AND
1.905µm MIN. TIN ON SOLDERTAIL OVER
1.270µm MIN. NICKEL OVERALL.
 - (4) 0.381µm MIN. GOLD PLATE ON CONTACT AND
1.905µm MIN. TIN ON SOLDERTAIL OVER
1.270µm MIN. NICKEL OVERALL.
 - (5) 0.762µm MIN. GOLD PLATE ON CONTACT AND
1.905µm MIN. TIN ON SOLDERTAIL OVER
1.270µm MIN. NICKEL OVERALL.
 - (6) 2.540µm/100µin MIN TIN OVERALL
1.270µm/50µin NICKEL OVERALL
3. PRODUCT SPECIFICATION: PS-87920-019
4. PACKAGING TYPE: SEE TABLE
5. WAFER TO BE FLAT WITHIN 0.003 mm/mm
6. RECOMMENDED PCB THICKNESS IS 1.60mm±0.10
- △ IRREGULAR CIRCUIT CUTOFF WITHIN BREAKAWAY SECTION IS PERMISSIBLE. CUTTING OR CHIPPING OF THE MAIN BODY IS NOT ACCEPTABLE
8. THE ABOVE CKT 6 IS FOR ILLUSTRATION PURPOSE ONLY
9. PACKAGING SPECIFICATION:
TRAY: PK-89990-489
BULK: PK-89990-491

THIS DRAWING CONTAINS INFORMATION THAT IS PROPRIETARY TO MOLEX ELECTRONIC TECHNOLOGIES, LLC AND SHOULD NOT BE USED WITHOUT WRITTEN PERMISSION		CURRENT REV DESC:		molex	
DIMENSION UNITS	SCALE				
mm	NTS			PRODUCT CUSTOMER DRAWING	
GENERAL TOLERANCES (UNLESS SPECIFIED)		EC NO: 679909		DOCUMENT NUMBER	
ANGULAR TOL ± 3.0 °		DRWN: AKUMAR19 2021/10/08		SD-87891-013	
4 PLACES ±		CHK'D: MRAMAKRISHNA 2021/10/11		DOC TYPE DOC PART REVISION	
3 PLACES ±		APPR: MRAMAKRISHNA 2021/10/11		PSD 001 B5	
2 PLACES ± 0.2		INITIAL REVISION:		MATERIAL NUMBER	
1 PLACE ±		DRWN: YLQIAO 2004/12/06		CUSTOMER	
0 PLACES ±		APPR: SLOW 2004/12/07		GENERAL MARKET	
DRAFT WHERE APPLICABLE MUST REMAIN WITHIN DIMENSIONS		THIRD ANGLE PROJECTION	DRAWING	SERIES	SHEET NUMBER
			A3-SIZE	87891	1 OF 8

DOCUMENT STATUS	P1	RELEASE DATE	2021/10/11	11:53:25
-----------------	----	--------------	------------	----------

10	9			8	7	6	5	4	3	2	1
	PACKAGING OPTION PART NO.										
TRAY	BULK	TUBE WITHOUT CAP	CKT SIZE	VOID POSITION	PLATING TYPE	A	B	F	M	P	
87891-0101	---	---	1	---	1	2.54	---	11.30	5.84	2.97	
87891-0102	---	---	1	---	2	2.54	---	11.30	5.84	2.97	
87891-0103	---	---	1	---	3	2.54	---	11.30	5.84	2.97	
87891-0104	---	---	1	---	4	2.54	---	11.30	5.84	2.97	
87891-0105	---	---	1	---	5	2.54	---	11.30	5.84	2.97	
87891-0106	---	---	1	---	6	2.54	---	11.30	5.84	2.97	
(B4) 87891-0109	---	---	1	---	6	2.54	---	11.30	5.84	2.97	
87891-0201	---	---	2	---	1	5.08	2.54	11.30	5.84	2.97	
87891-0202	---	---	2	---	2	5.08	2.54	11.30	5.84	2.97	
87891-0203	---	---	2	---	3	5.08	2.54	11.30	5.84	2.97	
87891-0204	---	---	2	---	4	5.08	2.54	11.30	5.84	2.97	
87891-0205	---	---	2	---	5	5.08	2.54	11.30	5.84	2.97	
87891-0206	---	---	2	---	6	5.08	2.54	11.30	5.84	2.97	
(B4) 87891-0211	---	---	2	---	6	5.08	2.54	11.30	5.84	2.97	
87891-0301	---	---	3	---	1	7.62	5.08	11.30	5.84	2.97	
87891-0302	---	---	3	---	2	7.62	5.08	11.30	5.84	2.97	
87891-0303	---	---	3	---	3	7.62	5.08	11.30	5.84	2.97	
87891-0304	---	---	3	---	4	7.62	5.08	11.30	5.84	2.97	
87891-0305	---	---	3	---	5	7.62	5.08	11.30	5.84	2.97	
87891-0306	---	---	3	---	6	7.62	5.08	11.30	5.84	2.97	
(B4) 87891-0308	---	---	3	---	6	7.62	5.08	11.30	5.84	2.97	

10	9			8	7	6	5	4	3	2	1
	PACKAGING OPTION PART NO.										
TRAY	BULK	TUBE WITHOUT CAP	CKT SIZE	VOID POSITION	PLATING TYPE	A	B	F	M	P	
87891-0401	---	---	4	---	1	10.16	7.62	11.30	5.84	2.97	
87891-0412	---	---	4	---	2	10.16	7.62	11.30	5.84	2.97	
87891-0403	---	---	4	---	3	10.16	7.62	11.30	5.84	2.97	
87891-0404	---	---	4	---	4	10.16	7.62	11.30	5.84	2.97	
87891-0405	---	---	4	---	5	10.16	7.62	11.30	5.84	2.97	
87891-0406	---	---	4	---	6	10.16	7.62	11.30	5.84	2.97	
87891-0511	---	---	5	---	1	12.70	10.16	11.30	5.84	2.97	
87891-0512	---	---	5	---	2	12.70	10.16	11.30	5.84	2.97	
87891-0513	---	---	5	---	3	12.70	10.16	11.30	5.84	2.97	
87891-0514	---	---	5	---	4	12.70	10.16	11.30	5.84	2.97	
87891-0515	---	---	5	---	5	12.70	10.16	11.30	5.84	2.97	
87891-0506	---	---	5	---	6	12.70	10.16	11.30	5.84	2.97	
(B4) 87891-0509	---	---	5	---	6	12.70	10.16	11.30	5.84	2.97	
87891-0601	---	---	6	---	1	15.24	12.70	11.30	5.84	2.97	
87891-0612	---	---	6	---	2	15.24	12.70	11.30	5.84	2.97	
87891-0603	---	---	6	---	3	15.24	12.70	11.30	5.84	2.97	
87891-0604	---	---	6	---	4	15.24	12.70	11.30	5.84	2.97	
87891-0605	---	---	6	---	5	15.24	12.70	11.30	5.84	2.97	
87891-0606	---	---	6	---	6	15.24	12.70	11.30	5.84	2.97	
(B4) 87891-0610	---	---	6	---	6	15.24	12.70	11.30	5.84	2.97	

F
E
D
C
B
A

F
E
D
C
B
A

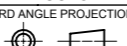
THIS DRAWING CONTAINS INFORMATION THAT IS PROPRIETARY TO MOLEX ELECTRONIC TECHNOLOGIES, LLC AND SHOULD NOT BE USED WITHOUT WRITTEN PERMISSION															
DIMENSION UNITS		SCALE		CURRENT REV DESC:											
mm		NTS													
GENERAL TOLERANCES (UNLESS SPECIFIED)				EC NO: 679909 DRWN: AKUMAR19 2021/10/08 CHK'D: MRAMAKRISHNA 2021/10/11 APPR: MRAMAKRISHNA 2021/10/11 INITIAL REVISION: DRWN: YLQIAO 2004/12/06 APPR: SCLOW 2004/12/07				CUSTOM HEADER							
ANGULAR TOL ± 3.0 °								2.54MM PITCH, SINGLE ROW SINGLE WAFER, T/H HEADER							
4 PLACES ±								PRODUCT CUSTOMER DRAWING							
3 PLACES ±								DOCUMENT NUMBER		DOC TYPE		DOC PART		REVISION	
2 PLACES ± 0.2								SD-87891-013		PSD		001		B5	
1 PLACE ±				MATERIAL NUMBER		CUSTOMER		SHEET NUMBER							
0 PLACES ±				SEE TABLE		GENERAL MARKET		2 OF 8							
DRAFT WHERE APPLICABLE MUST REMAIN WITHIN DIMENSIONS				THIRD ANGLE PROJECTION		DRAWING		SERIES							
						A3-SIZE		87891							

PACKAGING OPTION PART NO.			CKT SIZE	VOID POSITION	PLATING TYPE	DIMENSION				
TRAY	BULK	TUBE WITHOUT CAP				A	B	F	M	P
87891-0711	---	---	7	---	1	17.78	15.24	11.30	5.84	2.97
87891-0702	---	---	7	---	2	17.78	15.24	11.30	5.84	2.97
87891-0703	---	---	7	---	3	17.78	15.24	11.30	5.84	2.97
87891-0704	---	---	7	---	4	17.78	15.24	11.30	5.84	2.97
87891-0705	---	---	7	---	5	17.78	15.24	11.30	5.84	2.97
87891-0706	---	---	7	---	6	17.78	15.24	11.30	5.84	2.97
87891-0801	---	---	8	---	1	20.32	17.78	11.30	5.84	2.97
87891-0802	---	---	8	---	2	20.32	17.78	11.30	5.84	2.97
87891-0803	---	---	8	---	3	20.32	17.78	11.30	5.84	2.97
87891-0804	---	---	8	---	4	20.32	17.78	11.30	5.84	2.97
87891-0805	---	---	8	---	5	20.32	17.78	11.30	5.84	2.97
87891-0806	---	---	8	---	6	20.32	17.78	11.30	5.84	2.97
87891-0901	---	---	9	---	1	22.86	20.32	11.30	5.84	2.97
87891-0902	---	---	9	---	2	22.86	20.32	11.30	5.84	2.97
87891-0903	---	---	9	---	3	22.86	20.32	11.30	5.84	2.97
87891-0904	---	---	9	---	4	22.86	20.32	11.30	5.84	2.97
87891-0905	---	---	9	---	5	22.86	20.32	11.30	5.84	2.97
87891-0906	---	---	9	---	6	22.86	20.32	11.30	5.84	2.97

PACKAGING OPTION PART NO.			CKT SIZE	VOID POSITION	PLATING TYPE	DIMENSION				
TRAY	BULK	TUBE WITHOUT CAP				A	B	F	M	P
87891-1001	---	---	10	---	1	25.40	22.86	11.30	5.84	2.97
87891-1002	---	---	10	---	2	25.40	22.86	11.30	5.84	2.97
87891-1003	---	---	10	---	3	25.40	22.86	11.30	5.84	2.97
87891-1004	---	---	10	---	4	25.40	22.86	11.30	5.84	2.97
87891-1005	---	---	10	---	5	25.40	22.86	11.30	5.84	2.97
87891-1006	---	---	10	---	6	25.40	22.86	11.30	5.84	2.97
87891-1101	---	---	11	---	1	27.94	25.40	11.30	5.84	2.97
87891-1102	---	---	11	---	2	27.94	25.40	11.30	5.84	2.97
87891-1103	---	---	11	---	3	27.94	25.40	11.30	5.84	2.97
87891-1104	---	---	11	---	4	27.94	25.40	11.30	5.84	2.97
87891-1105	---	---	11	---	5	27.94	25.40	11.30	5.84	2.97
87891-1106	---	---	11	---	6	27.94	25.40	11.30	5.84	2.97
87891-1201	---	---	12	---	1	30.48	27.94	11.30	5.84	2.97
87891-1202	---	---	12	---	2	30.48	27.94	11.30	5.84	2.97
87891-1203	---	---	12	---	3	30.48	27.94	11.30	5.84	2.97
87891-1204	---	---	12	---	4	30.48	27.94	11.30	5.84	2.97
87891-1205	---	---	12	---	5	30.48	27.94	11.30	5.84	2.97
87891-1206	---	---	12	---	6	30.48	27.94	11.30	5.84	2.97

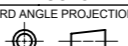
THIS DRAWING CONTAINS INFORMATION THAT IS PROPRIETARY TO MOLEX ELECTRONIC TECHNOLOGIES, LLC AND SHOULD NOT BE USED WITHOUT WRITTEN PERMISSION									
DIMENSION UNITS	SCALE	CURRENT REV DESC:			 CUSTOMER HEADER 2.54MM PITCH, SINGLE ROW SINGLE WAFER, T/H HEADER				
mm	NTS								
GENERAL TOLERANCES (UNLESS SPECIFIED)		EC NO: 679909							
ANGULAR TOL ± 3.0 °		DRWN: AKUMAR19 2021/10/08							
4 PLACES ±		CHK'D: MRAMAKRISHNA 2021/10/11							
3 PLACES ±		APPR: MRAMAKRISHNA 2021/10/11							
2 PLACES ± 0.2		INITIAL REVISION:			DOCUMENT NUMBER				
1 PLACE ±		DRWN: YLQIAO 2004/12/06			SD-87891-013				
0 PLACES ±		APPR: SCLOW 2004/12/07			DOC TYPE DOC PART REVISION				
DRAFT WHERE APPLICABLE MUST REMAIN WITHIN DIMENSIONS		THIRD ANGLE PROJECTION	DRAWING	SERIES	MATERIAL NUMBER	CUSTOMER	SHEET NUMBER		
			A3-SIZE	87891	SEE TABLE	GENERAL MARKET	3 OF 8		

DOCUMENT STATUS	P1	RELEASE DATE	2021/10/11	11:53:25
-----------------	----	--------------	------------	----------

PACKAGING OPTION PART NO.			CKT SIZE	VOID POSITION	PLATING TYPE	DIMENSION				
TRAY	BULK	TUBE WITHOUT CAP				A	B	F	M	P
87891-1301	---	---	13	---	1	33.02	30.48	11.30	5.84	2.97
87891-1302	---	---	13	---	2	33.02	30.48	11.30	5.84	2.97
87891-1303	---	---	13	---	3	33.02	30.48	11.30	5.84	2.97
87891-1304	---	---	13	---	4	33.02	30.48	11.30	5.84	2.97
87891-1305	---	---	13	---	5	33.02	30.48	11.30	5.84	2.97
87891-1306	---	---	13	---	6	33.02	30.48	11.30	5.84	2.97
87891-1401	---	---	14	---	1	35.56	33.02	11.30	5.84	2.97
87891-1402	---	---	14	---	2	35.56	33.02	11.30	5.84	2.97
87891-1403	---	---	14	---	3	35.56	33.02	11.30	5.84	2.97
87891-1404	---	---	14	---	4	35.56	33.02	11.30	5.84	2.97
87891-1405	---	---	14	---	5	35.56	33.02	11.30	5.84	2.97
87891-1406	---	---	14	---	6	35.56	33.02	11.30	5.84	2.97
87891-1501	---	---	15	---	1	38.10	35.56	11.30	5.84	2.97
87891-1502	---	---	15	---	2	38.10	35.56	11.30	5.84	2.97
87891-1503	---	---	15	---	3	38.10	35.56	11.30	5.84	2.97
87891-1504	---	---	15	---	4	38.10	35.56	11.30	5.84	2.97
87891-1505	---	---	15	---	5	38.10	35.56	11.30	5.84	2.97
87891-1506	---	---	15	---	6	38.10	35.56	11.30	5.84	2.97

PACKAGING OPTION PART NO.			CKT SIZE	VOID POSITION	PLATING TYPE	DIMENSION				
TRAY	BULK	TUBE WITHOUT CAP				A	B	F	M	P
87891-1601	---	---	16	---	1	40.64	38.10	11.30	5.84	2.97
87891-1602	---	---	16	---	2	40.64	38.10	11.30	5.84	2.97
87891-1603	---	---	16	---	3	40.64	38.10	11.30	5.84	2.97
87891-1604	---	---	16	---	4	40.64	38.10	11.30	5.84	2.97
87891-1605	---	---	16	---	5	40.64	38.10	11.30	5.84	2.97
87891-1606	---	---	16	---	6	40.64	38.10	11.30	5.84	2.97
87891-1701	---	---	17	---	1	43.18	40.64	11.30	5.84	2.97
87891-1702	---	---	17	---	2	43.18	40.64	11.30	5.84	2.97
87891-1703	---	---	17	---	3	43.18	40.64	11.30	5.84	2.97
87891-1704	---	---	17	---	4	43.18	40.64	11.30	5.84	2.97
87891-1705	---	---	17	---	5	43.18	40.64	11.30	5.84	2.97
87891-1706	---	---	17	---	6	43.18	40.64	11.30	5.84	2.97
87891-1801	---	---	18	---	1	45.72	43.18	11.30	5.84	2.97
87891-1802	---	---	18	---	2	45.72	43.18	11.30	5.84	2.97
87891-1803	---	---	18	---	3	45.72	43.18	11.30	5.84	2.97
87891-1804	---	---	18	---	4	45.72	43.18	11.30	5.84	2.97
87891-1805	---	---	18	---	5	45.72	43.18	11.30	5.84	2.97
87891-1806	---	---	18	---	6	45.72	43.18	11.30	5.84	2.97

DOCUMENT STATUS	P1	RELEASE DATE	2021/10/11	11:53:25
-----------------	----	--------------	------------	----------

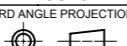
THIS DRAWING CONTAINS INFORMATION THAT IS PROPRIETARY TO MOLEX ELECTRONIC TECHNOLOGIES, LLC AND SHOULD NOT BE USED WITHOUT WRITTEN PERMISSION										
DIMENSION UNITS	SCALE	CURRENT REV DESC:			 CUSTOMER HEADER 2.54MM PITCH, SINGLE ROW SINGLE WAFER, T/H HEADER					
mm	NTS									
GENERAL TOLERANCES (UNLESS SPECIFIED)		EC NO: 679909								
ANGULAR TOL ± 3.0 °		DRWN: AKUMAR19 2021/10/08								
4 PLACES ±		CHK'D: MRAMAKRISHNA 2021/10/11								
3 PLACES ±		APPR: MRAMAKRISHNA 2021/10/11								
2 PLACES ± 0.2		INITIAL REVISION:			DOCUMENT NUMBER					
1 PLACE ±		DRWN: YLQIAO 2004/12/06			SD-87891-013			DOC TYPE	DOC PART	REVISION
0 PLACES ±		APPR: SLOW 2004/12/07						PSD	001	B5
DRAFT WHERE APPLICABLE MUST REMAIN WITHIN DIMENSIONS		THIRD ANGLE PROJECTION	DRAWING	SERIES	MATERIAL NUMBER	CUSTOMER		SHEET NUMBER		
			A3-SIZE	87891	SEE TABLE	GENERAL MARKET		4 OF 8		

	PACKAGING OPTION PART NO.			CKT SIZE	VOID POSITION	PLATING TYPE	DIMENSION				
	TRAY	BULK	TUBE WITHOUT CAP				A	B	F	M	P
F	87891-1901	---	---	19	---	1	48.26	45.72	11.30	5.84	2.97
	87891-1902	---	---	19	---	2	48.26	45.72	11.30	5.84	2.97
	87891-1903	---	---	19	---	3	48.26	45.72	11.30	5.84	2.97
	87891-1904	---	---	19	---	4	48.26	45.72	11.30	5.84	2.97
	87891-1905	---	---	19	---	5	48.26	45.72	11.30	5.84	2.97
	87891-1906	---	---	19	---	6	48.26	45.72	11.30	5.84	2.97
E	87891-2001	---	---	20	---	1	50.80	48.26	11.30	5.84	2.97
	87891-2002	---	---	20	---	2	50.80	48.26	11.30	5.84	2.97
	87891-2003	---	---	20	---	3	50.80	48.26	11.30	5.84	2.97
	87891-2004	---	---	20	---	4	50.80	48.26	11.30	5.84	2.97
	87891-2005	---	---	20	---	5	50.80	48.26	11.30	5.84	2.97
	87891-2006	---	---	20	---	6	50.80	48.26	11.30	5.84	2.97
D	87891-2101	---	---	21	---	1	53.34	50.80	11.30	5.84	2.97
	87891-2102	---	---	21	---	2	53.34	50.80	11.30	5.84	2.97
	87891-2103	---	---	21	---	3	53.34	50.80	11.30	5.84	2.97
	87891-2104	---	---	21	---	4	53.34	50.80	11.30	5.84	2.97
	87891-2105	---	---	21	---	5	53.34	50.80	11.30	5.84	2.97
	87891-2106	---	---	21	---	6	53.34	50.80	11.30	5.84	2.97

	PACKAGING OPTION PART NO.			CKT SIZE	VOID POSITION	PLATING TYPE	DIMENSION				
	TRAY	BULK	TUBE WITHOUT CAP				A	B	F	M	P
F	87891-2201	---	---	22	---	1	55.88	53.34	11.30	5.84	2.97
	87891-2202	---	---	22	---	2	55.88	53.34	11.30	5.84	2.97
	87891-2203	---	---	22	---	3	55.88	53.34	11.30	5.84	2.97
	87891-2204	---	---	22	---	4	55.88	53.34	11.30	5.84	2.97
	87891-2205	---	---	22	---	5	55.88	53.34	11.30	5.84	2.97
	87891-2206	---	---	22	---	6	55.88	53.34	11.30	5.84	2.97
E	87891-2301	---	---	23	---	1	58.42	55.88	11.30	5.84	2.97
	87891-2302	---	---	23	---	2	58.42	55.88	11.30	5.84	2.97
	87891-2303	---	---	23	---	3	58.42	55.88	11.30	5.84	2.97
	87891-2304	---	---	23	---	4	58.42	55.88	11.30	5.84	2.97
	87891-2305	---	---	23	---	5	58.42	55.88	11.30	5.84	2.97
	87891-2306	---	---	23	---	6	58.42	55.88	11.30	5.84	2.97
D	87891-2401	---	---	24	---	1	60.96	58.42	11.30	5.84	2.97
	87891-2402	---	---	24	---	2	60.96	58.42	11.30	5.84	2.97
	87891-2403	---	---	24	---	3	60.96	58.42	11.30	5.84	2.97
	87891-2404	---	---	24	---	4	60.96	58.42	11.30	5.84	2.97
	87891-2405	---	---	24	---	5	60.96	58.42	11.30	5.84	2.97
	87891-2406	---	---	24	---	6	60.96	58.42	11.30	5.84	2.97

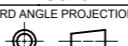
THIS DRAWING CONTAINS INFORMATION THAT IS PROPRIETARY TO MOLEX ELECTRONIC TECHNOLOGIES, LLC AND SHOULD NOT BE USED WITHOUT WRITTEN PERMISSION														
DIMENSION UNITS		SCALE		CURRENT REV DESC:										
mm		NTS												
GENERAL TOLERANCES (UNLESS SPECIFIED)				EC NO: 679909 DRWN: AKUMAR19 2021/10/08 CHK'D: MRAMAKRISHNA 2021/10/11 APPR: MRAMAKRISHNA 2021/10/11 INITIAL REVISION: DRWN: YLQIAO 2004/12/06 APPR: SLOW 2004/12/07						CUSTOM HEADER				
ANGULAR TOL ± 3.0 °										2.54MM PITCH, SINGLE ROW SINGLE WAFER, T/H HEADER				
4 PLACES ±										PRODUCT CUSTOMER DRAWING				
3 PLACES ±										DOCUMENT NUMBER		DOC TYPE	DOC PART	REVISION
2 PLACES ± 0.2										SD-87891-013		PSD	001	B5
1 PLACE ±				MATERIAL NUMBER		CUSTOMER		SHEET NUMBER						
0 PLACES ±				SEE TABLE		GENERAL MARKET		5 OF 8						
DRAFT WHERE APPLICABLE MUST REMAIN WITHIN DIMENSIONS				THIRD ANGLE PROJECTION		DRAWING	SERIES	MATERIAL NUMBER	CUSTOMER	SHEET NUMBER				
						A3-SIZE	87891	SEE TABLE	GENERAL MARKET	5 OF 8				

DOCUMENT STATUS	P1	RELEASE DATE	2021/10/11	11:53:25
-----------------	----	--------------	------------	----------

PACKAGING OPTION PART NO.			CKT SIZE	VOID POSITION	PLATING TYPE	DIMENSION				
TRAY	BULK	TUBE WITHOUT CAP				A	B	F	M	P
87891-2501	---	---	25	---	1	63.50	60.96	11.30	5.84	2.97
87891-2502	---	---	25	---	2	63.50	60.96	11.30	5.84	2.97
87891-2503	---	---	25	---	3	63.50	60.96	11.30	5.84	2.97
87891-2504	---	---	25	---	4	63.50	60.96	11.30	5.84	2.97
87891-2505	---	---	25	---	5	63.50	60.96	11.30	5.84	2.97
87891-2506	---	---	25	---	6	63.50	60.96	11.30	5.84	2.97
---	87891-2611	---	26	---	1	66.04	63.50	11.30	5.84	2.97
---	87891-2602	---	26	---	2	66.04	63.50	11.30	5.84	2.97
---	87891-2603	---	26	---	3	66.04	63.50	11.30	5.84	2.97
---	87891-2604	---	26	---	4	66.04	63.50	11.30	5.84	2.97
---	87891-2605	---	26	---	5	66.04	63.50	11.30	5.84	2.97
---	87891-2606	---	26	---	6	66.04	63.50	11.30	5.84	2.97
---	87891-2701	---	27	---	1	68.58	66.04	11.30	5.84	2.97
---	87891-2702	---	27	---	2	68.58	66.04	11.30	5.84	2.97
---	87891-2703	---	27	---	3	68.58	66.04	11.30	5.84	2.97
---	87891-2704	---	27	---	4	68.58	66.04	11.30	5.84	2.97
---	87891-2705	---	27	---	5	68.58	66.04	11.30	5.84	2.97
---	87891-2706	---	27	---	6	68.58	66.04	11.30	5.84	2.97

PACKAGING OPTION PART NO.			CKT SIZE	VOID POSITION	PLATING TYPE	DIMENSION				
TRAY	BULK	TUBE WITHOUT CAP				A	B	F	M	P
---	87891-2801	---	28	---	1	71.12	68.58	11.30	5.84	2.97
---	87891-2802	---	28	---	2	71.12	68.58	11.30	5.84	2.97
---	87891-2803	---	28	---	3	71.12	68.58	11.30	5.84	2.97
---	87891-2804	---	28	---	4	71.12	68.58	11.30	5.84	2.97
---	87891-2805	---	28	---	5	71.12	68.58	11.30	5.84	2.97
---	87891-2806	---	28	---	6	71.12	68.58	11.30	5.84	2.97
---	87891-2901	---	29	---	1	73.66	71.12	11.30	5.84	2.97
---	87891-2902	---	29	---	2	73.66	71.12	11.30	5.84	2.97
---	87891-2903	---	29	---	3	73.66	71.12	11.30	5.84	2.97
---	87891-2904	---	29	---	4	73.66	71.12	11.30	5.84	2.97
---	87891-2905	---	29	---	5	73.66	71.12	11.30	5.84	2.97
---	87891-2906	---	29	---	6	73.66	71.12	11.30	5.84	2.97
---	87891-3001	---	30	---	1	76.20	73.66	11.30	5.84	2.97
---	87891-3002	---	30	---	2	76.20	73.66	11.30	5.84	2.97
---	87891-3003	---	30	---	3	76.20	73.66	11.30	5.84	2.97
---	87891-3004	---	30	---	4	76.20	73.66	11.30	5.84	2.97
---	87891-3005	---	30	---	5	76.20	73.66	11.30	5.84	2.97
---	87891-3006	---	30	---	6	76.20	73.66	11.30	5.84	2.97

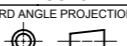
THIS DRAWING CONTAINS INFORMATION THAT IS PROPRIETARY TO MOLEX ELECTRONIC TECHNOLOGIES, LLC AND SHOULD NOT BE USED WITHOUT WRITTEN PERMISSION									
DIMENSION UNITS		SCALE		CURRENT REV DESC:					
mm		NTS		 CUSTOMER HEADER 2.54MM PITCH, SINGLE ROW SINGLE WAFER, T/H HEADER PRODUCT CUSTOMER DRAWING					
GENERAL TOLERANCES (UNLESS SPECIFIED)									
ANGULAR TOL ± 3.0 °									
4 PLACES		±							
3 PLACES		±							
2 PLACES		± 0.2		EC NO: 679909		DRWN: AKUMAR19		2021/10/08	
1 PLACE		±		CHK'D: MRAMAKRISHNA		APPR: MRAMAKRISHNA		2021/10/11	
0 PLACES		±		INITIAL REVISION:		DRWN: YLQIAO		2004/12/06	
DRAFT WHERE APPLICABLE MUST REMAIN WITHIN DIMENSIONS		THIRD ANGLE PROJECTION		DRAWING		SERIES		MATERIAL NUMBER	
				A3-SIZE		87891		SEE TABLE	
				CUSTOMER		GENERAL MARKET		SHEET NUMBER	
								6 OF 8	

PACKAGING OPTION PART NO.			CKT SIZE	VOID POSITION	PLATING TYPE	DIMENSION				
TRAY	BULK	TUBE WITHOUT CAP				A	B	F	M	P
---	87891-3101	---	31	---	1	78.74	76.20	11.30	5.84	2.97
---	87891-3102	---	31	---	2	78.74	76.20	11.30	5.84	2.97
---	87891-3103	---	31	---	3	78.74	76.20	11.30	5.84	2.97
---	87891-3104	---	31	---	4	78.74	76.20	11.30	5.84	2.97
---	87891-3105	---	31	---	5	78.74	76.20	11.30	5.84	2.97
---	87891-3106	---	31	---	6	78.74	76.20	11.30	5.84	2.97
---	87891-3201	---	32	---	1	81.28	78.74	11.30	5.84	2.97
---	87891-3202	---	32	---	2	81.28	78.74	11.30	5.84	2.97
---	87891-3203	---	32	---	3	81.28	78.74	11.30	5.84	2.97
---	87891-3204	---	32	---	4	81.28	78.74	11.30	5.84	2.97
---	87891-3205	---	32	---	5	81.28	78.74	11.30	5.84	2.97
---	87891-3206	---	32	---	6	81.28	78.74	11.30	5.84	2.97
---	87891-3301	---	33	---	1	83.82	81.28	11.30	5.84	2.97
---	87891-3302	---	33	---	2	83.82	81.28	11.30	5.84	2.97
---	87891-3303	---	33	---	3	83.82	81.28	11.30	5.84	2.97
---	87891-3304	---	33	---	4	83.82	81.28	11.30	5.84	2.97
---	87891-3305	---	33	---	5	83.82	81.28	11.30	5.84	2.97
---	87891-3306	---	33	---	6	83.82	81.28	11.30	5.84	2.97

PACKAGING OPTION PART NO.			CKT SIZE	VOID POSITION	PLATING TYPE	DIMENSION				
TRAY	BULK	TUBE WITHOUT CAP				A	B	F	M	P
---	87891-3401	---	34	---	1	86.36	83.82	11.30	5.84	2.97
---	87891-3402	---	34	---	2	86.36	83.82	11.30	5.84	2.97
---	87891-3403	---	34	---	3	86.36	83.82	11.30	5.84	2.97
---	87891-3404	---	34	---	4	86.36	83.82	11.30	5.84	2.97
---	87891-3405	---	34	---	5	86.36	83.82	11.30	5.84	2.97
---	87891-3406	---	34	---	6	86.36	83.82	11.30	5.84	2.97
---	87891-3501	---	35	---	1	88.90	86.36	11.30	5.84	2.97
---	87891-3502	---	35	---	2	88.90	86.36	11.30	5.84	2.97
---	87891-3503	---	35	---	3	88.90	86.36	11.30	5.84	2.97
---	87891-3504	---	35	---	4	88.90	86.36	11.30	5.84	2.97
---	87891-3505	---	35	---	5	88.90	86.36	11.30	5.84	2.97
---	87891-3506	---	35	---	6	88.90	86.36	11.30	5.84	2.97
---	87891-3611	---	36	---	1	91.44	88.90	11.30	5.84	2.97
---	87891-3602	---	36	---	2	91.44	88.90	11.30	5.84	2.97
---	87891-3603	---	36	---	3	91.44	88.90	11.30	5.84	2.97
---	87891-3604	---	36	---	4	91.44	88.90	11.30	5.84	2.97
---	87891-3605	---	36	---	5	91.44	88.90	11.30	5.84	2.97
---	87891-3606	---	36	---	6	91.44	88.90	11.30	5.84	2.97

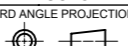
THIS DRAWING CONTAINS INFORMATION THAT IS PROPRIETARY TO MOLEX ELECTRONIC TECHNOLOGIES, LLC AND SHOULD NOT BE USED WITHOUT WRITTEN PERMISSION										
DIMENSION UNITS	SCALE	CURRENT REV DESC:								
mm	NTS									
GENERAL TOLERANCES (UNLESS SPECIFIED)		EC NO: 679909					CUSTOM HEADER 2.54MM PITCH, SINGLE ROW SINGLE WAFER, T/H HEADER			
ANGULAR TOL ± 3.0°		DRWN: AKUMAR19 2021/10/08								
4 PLACES ±	CHK'D: MRAMAKRISHNA 2021/10/11					PRODUCT CUSTOMER DRAWING				
3 PLACES ±	APPR: MRAMAKRISHNA 2021/10/11									
2 PLACES ± 0.2	INITIAL REVISION:					DOCUMENT NUMBER	DOC TYPE	DOC PART	REVISION	
1 PLACE ±	DRWN: YLQIAO 2004/12/06					SD-87891-013	PSD	001	B5	
0 PLACES ±	APPR: SLOW 2004/12/07									
DRAFT WHERE APPLICABLE MUST REMAIN WITHIN DIMENSIONS	THIRD ANGLE PROJECTION	DRAWING	SERIES	MATERIAL NUMBER	CUSTOMER	SHEET NUMBER				
		A3-SIZE	87891	SEE TABLE	GENERAL MARKET	7 OF 8				

DOCUMENT STATUS	P1	RELEASE DATE	2021/10/11	11:53:25
-----------------	----	--------------	------------	----------

PACKAGING OPTION PART NO.			CKT SIZE	VOID POSITION	PLATING TYPE	DIMENSION				
TRAY	BULK	TUBE WITHOUT CAP				A	B	F	M	P
---	87891-3701	---	37	---	1	93.98	91.44	11.30	5.84	2.97
---	87891-3702	---	37	---	2	93.98	91.44	11.30	5.84	2.97
---	87891-3703	---	37	---	3	93.98	91.44	11.30	5.84	2.97
---	87891-3704	---	37	---	4	93.98	91.44	11.30	5.84	2.97
---	87891-3705	---	37	---	5	93.98	91.44	11.30	5.84	2.97
---	87891-3706	---	37	---	6	93.98	91.44	11.30	5.84	2.97
---	87891-3801	---	38	---	1	96.52	93.98	11.30	5.84	2.97
---	87891-3802	---	38	---	2	96.52	93.98	11.30	5.84	2.97
---	87891-3803	---	38	---	3	96.52	93.98	11.30	5.84	2.97
---	87891-3804	---	38	---	4	96.52	93.98	11.30	5.84	2.97
---	87891-3805	---	38	---	5	96.52	93.98	11.30	5.84	2.97
---	87891-3806	---	38	---	6	96.52	93.98	11.30	5.84	2.97
---	87891-3901	---	39	---	1	99.06	96.52	11.30	5.84	2.97
---	87891-3902	---	39	---	2	99.06	96.52	11.30	5.84	2.97
---	87891-3903	---	39	---	3	99.06	96.52	11.30	5.84	2.97
---	87891-3904	---	39	---	4	99.06	96.52	11.30	5.84	2.97
---	87891-3905	---	39	---	5	99.06	96.52	11.30	5.84	2.97
---	87891-3906	---	39	---	6	99.06	96.52	11.30	5.84	2.97

PACKAGING OPTION PART NO.			CKT SIZE	VOID POSITION	PLATING TYPE	DIMENSION				
TRAY	BULK	TUBE WITHOUT CAP				A	B	F	M	P
---	87891-4001	---	40	---	1	101.60	99.06	11.30	5.84	2.97
---	87891-4002	---	40	---	2	101.60	99.06	11.30	5.84	2.97
---	87891-4003	---	40	---	3	101.60	99.06	11.30	5.84	2.97
---	87891-4004	---	40	---	4	101.60	99.06	11.30	5.84	2.97
---	87891-4005	---	40	---	5	101.60	99.06	11.30	5.84	2.97
---	87891-4006	---	40	---	6	101.60	99.06	11.30	5.84	2.97

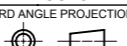
THIS DRAWING CONTAINS INFORMATION THAT IS PROPRIETARY TO MOLEX ELECTRONIC TECHNOLOGIES, LLC AND SHOULD NOT BE USED WITHOUT WRITTEN PERMISSION									
DIMENSION UNITS	SCALE	CURRENT REV DESC:			 CUSTOMER HEADER 2.54MM PITCH, SINGLE ROW SINGLE WAFER, T/H HEADER				
mm	NTS								
GENERAL TOLERANCES (UNLESS SPECIFIED)					PRODUCT CUSTOMER DRAWING				
ANGULAR TOL	± 3.0 °	EC NO: 679909			DOCUMENT NUMBER				
4 PLACES	±	DRWN: AKUMAR19 2021/10/08			SD-87891-013				
3 PLACES	±	CHK'D: MRAMAKRISHNA 2021/10/11			DOC TYPE				
2 PLACES	± 0.2	APPR: MRAMAKRISHNA 2021/10/11			PSD				
1 PLACE	±	INITIAL REVISION:			DOC PART				
0 PLACES	±	DRWN: YLQIAO 2004/12/06			001				
					REVISION				
					B5				
DRAFT WHERE APPLICABLE MUST REMAIN WITHIN DIMENSIONS		THIRD ANGLE PROJECTION	DRAWING	SERIES	MATERIAL NUMBER	CUSTOMER	SHEET NUMBER		
			A3-SIZE	87891	SEE TABLE	GENERAL MARKET	8 OF 8		