

Data sheet | Item number: 2042-1108

Switching module; with momentary switch; Switching voltage: 250 VAC;  
translucent

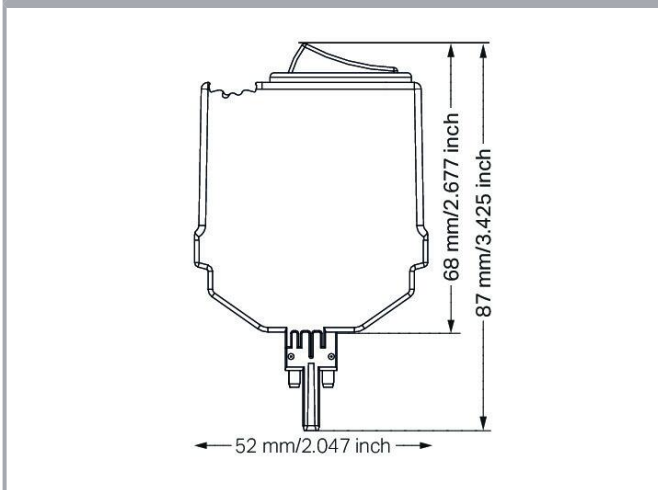

[www.wago.com/2042-1108](http://www.wago.com/2042-1108)

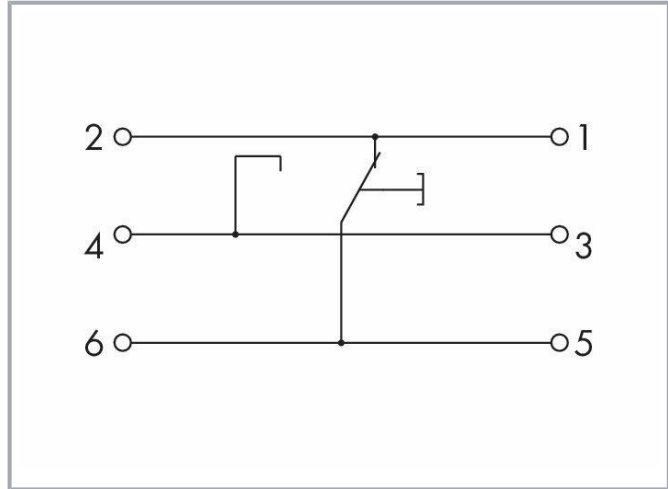

Data

Electrical data

Switching current (resistive) max.

10 A

Subject to changes. Please also observe the further product documentation!

WAGO GmbH & Co. KG  
Hansastr. 27  
32423 Minden  
Phone: +49571 887-0 | Fax: +49571 887-169  
Email: [info.de@wago.com](mailto:info.de@wago.com) | Web: [www.wago.com](http://www.wago.com)

Do you have any questions about our products?  
We are always happy to take your call at +49 (571) 887-44222.



|   |   |
|---|---|
| Inrush current (max.)                       | 128 A   |
| Switching voltage (max.)                    | AC 250 V  |
| Contact resistance                          | ≤ 20 mΩ   |
| Insulation resistance                       | ≥ 100 MΩ (500 VDC; New condition)   |
| Electrical life (NO; resistive load; 23 °C) | 10 x 10 <sup>3</sup> switching operations; UL: 6 x 10 <sup>3</sup> switching operations |

## Safety and protection

|  |                       |
|--|-----------------------|
| Rated voltage                                  | 250 V                 |
| Pollution degree                               | 2                     |
| Overvoltage category                           | II                    |
| Dielectric strength (open contact) (AC, 1 min) | 1.5 kV <sub>rms</sub> |
| Protection type                                | IP20                  |

## Physical data

|                         |                       |
|-------------------------|-----------------------|
| Width                   | 15.5 mm / 0.61 inches |
| Height                  | 87 mm / 3.425 inches  |
| Height from the surface | 68 mm / 2.677 inches  |
| Depth                   | 52 mm / 2.047 inches  |

## Mechanical Data

|               |   |
|---------------|---|
| Mounting type | Pluggable module for TOPJOB® S Carrier Terminal Block |
|---------------|---|

## Material Data

|                             |             |
|-----------------------------|-------------|
| Color                       | translucent |
| Flammability class per UL94 | V0          |
| Fire load                   | 0.149 MJ    |
| Weight                      | 29.3 g      |

## Environmental requirements

|                                 |                |
|---------------------------------|----------------|
| Ambient temperature (operation) | -25 ... +70 °C |
| Ambient temperature (storage)   | -40 ... +85 °C |
| Operating altitude (max.)       | 2000 m         |

## Standards and specifications

|                          |                |
|--------------------------|----------------|
| Standards/specifications | EN 61010-2-201 |
|--------------------------|----------------|

Subject to changes. Please also observe the further product documentation!

WAGO GmbH & Co. KG  
 Hansastr. 27  
 32423 Minden  
 Phone: +49571 887-0 | Fax: +49571 887-169  
 Email: [info.de@wago.com](mailto:info.de@wago.com) | Web: [www.wago.com](http://www.wago.com)

Do you have any questions about our products?  
 We are always happy to take your call at +49 (571) 887-44222.

EN 50155  
EN 61373

### Commercial data



|                       |               |
|-----------------------|---------------|
| eCl@ss 10.0           | 27-14-11-49   |
| eCl@ss 9.0            | 27-14-11-49   |
| ETIM 8.0              | EC002018      |
| ETIM 7.0              | EC002018      |
| PU (SPU)              | 1 pcs         |
| Packaging type        | bag           |
| Country of origin     | DE            |
| GTIN                  | 4055143883818 |
| Customs tariff number | 85365080900   |

### Environmental Product Compliance

|                        |                         |
|------------------------|-------------------------|
| RoHS Compliance Status | Compliant, No Exemption |
|------------------------|-------------------------|

### Approvals / Certificates

#### General approvals

| Logo   | Approval  | Additional Approval Text | Certificate name            |
|--|---|--------------------------|-----------------------------|
|  | EAC<br>Brjansker Zertifizierungsstelle                    | TP TC 004/2011           | EAC RU C-DE.AM02.B.00122/19 |
|  | UL<br>Underwriters Laboratories Inc. (ORDINARY LOCATIONS) | UL 61010-1               | E175199                     |

#### Declarations of conformity and manufacturer's declarations

| Logo   | Approval   | Additional Approval Text | Certificate name |
|--|--|--------------------------|------------------|
|  | EU-Declaration of Conformity<br>WAGO GmbH & Co. KG | -                        | -                |







Subject to changes. Please also observe the further product documentation!

WAGO GmbH & Co. KG  
Hansastr. 27  
32423 Minden  
Phone: +49571 887-0 | Fax: +49571 887-169  
Email: [info.de@wago.com](mailto:info.de@wago.com) | Web: [www.wago.com](http://www.wago.com)



Do you have any questions about our products?  
We are always happy to take your call at +49 (571) 887-44222.

## Optional accessories

### End plate

| End plate   |  |  |
|---|--|--|
|   | <b>Item no.: 2002-1892</b><br>End and intermediate plate; 1 mm thick; orange | <a href="http://www.wago.com/2002-1892">www.wago.com/2002-1892</a> |
|   | <b>Item no.: 2002-1891</b><br>End and intermediate plate; 1 mm thick; gray   | <a href="http://www.wago.com/2002-1891">www.wago.com/2002-1891</a> |
|   | <b>Item no.: 2002-1991</b><br>End and intermediate plate; 1 mm thick; gray   | <a href="http://www.wago.com/2002-1991">www.wago.com/2002-1991</a> |
|   | <b>Item no.: 2002-1992</b><br>End and intermediate plate; 1 mm thick; orange | <a href="http://www.wago.com/2002-1992">www.wago.com/2002-1992</a> |
|   | <b>Item no.: 2002-1691</b><br>End and intermediate plate; 1 mm thick; gray   | <a href="http://www.wago.com/2002-1691">www.wago.com/2002-1691</a> |
|   | <b>Item no.: 2002-1692</b><br>End and intermediate plate; 1 mm thick; orange | <a href="http://www.wago.com/2002-1692">www.wago.com/2002-1692</a> |
|   | <b>Item no.: 2002-1791</b><br>End and intermediate plate; 1 mm thick; gray   | <a href="http://www.wago.com/2002-1791">www.wago.com/2002-1791</a> |
|  | <b>Item no.: 2002-1792</b><br>End and intermediate plate; 1 mm thick; orange | <a href="http://www.wago.com/2002-1792">www.wago.com/2002-1792</a> |

### Terminal blocks

| Carrier terminal block for modules and plugs                                       |  |  |
|--|--|--|
|  | <b>Item no.: 2002-1961</b><br>2-conductor carrier terminal block; with additional jumper position; for DIN-rail 35 x 15 and 35 x 7.5; 2.5 mm <sup>2</sup> ; Push-in CAGE CLAMP®; 2,50 mm <sup>2</sup> ; gray | <a href="http://www.wago.com/2002-1961">www.wago.com/2002-1961</a> |
|  | <b>Item no.: 2002-1761</b><br>3-conductor carrier terminal block; for DIN-rail 35 x 15 and 35 x 7.5; 2.5 mm <sup>2</sup> ; Push-in CAGE CLAMP®; 2,50 mm <sup>2</sup> ; gray                                  | <a href="http://www.wago.com/2002-1761">www.wago.com/2002-1761</a> |
|  | <b>Item no.: 2002-1861</b><br>4-conductor carrier terminal block; for DIN-rail 35 x 15 and 35 x 7.5; 2.5 mm <sup>2</sup> ; Push-in CAGE CLAMP®; 2,50 mm <sup>2</sup> ; gray                                  | <a href="http://www.wago.com/2002-1861">www.wago.com/2002-1861</a> |

### Marking accessories

| Marking strip  |  |  |
|--|--|--|
|  | <b>Item no.: 2009-110</b><br>Marking strips; for Smart Printer; on reel; not stretchable; plain; snap-on type; white | <a href="http://www.wago.com/2009-110">www.wago.com/2009-110</a> |
| Marker   |  |  |

Subject to changes. Please also observe the further product documentation!



Item no.: 2009-115

WMB-Inline; for Smart Printer; 1500 pieces on roll; stretchable 5 - 5.2 mm; plain; snap-on type; white

[www.wago.com/2009-115](http://www.wago.com/2009-115)



Item no.: 793-501

WMB marking card; as card; not stretchable; plain; snap-on type; white

[www.wago.com/793-501](http://www.wago.com/793-501)



Item no.: 793-5501

WMB marking card; as card; for terminal block width 5 - 17.5 mm; stretchable 5 - 5.2 mm; plain; snap-on type; white

[www.wago.com/793-5501](http://www.wago.com/793-5501)

## Downloads

### Documentation

#### Bid Text

|                           |             |                 |          |
|---------------------------|-------------|-----------------|----------|
| 2042-1108<br>X81 - Datei  | 2019 Feb 19 | xml<br>3.8 kB   | Download |
| 2042-1108<br>docx - Datei | 2019 Jan 9  | docx<br>15.2 kB | Download |

#### Additional Information

|   |                        |               |          |
|---|------------------------|---------------|----------|
| Disposal and Recycling<br>Electrical and electronic equipment, Batteries, Packaging | V 1.1.0<br>2022 Aug 18 | pdf<br>2.2 MB | Download |
|---|------------------------|---------------|----------|

## CAD/CAE-Data

### CAD data

|                        |     |          |
|------------------------|-----|----------|
| 2D/3D Models 2042-1108 | URL | Download |
|------------------------|-----|----------|

## Environmental Product Compliance

### Compliance Search

|  |     |          |
|--|-----|----------|
| Environmental Product Compliance 2042-1108<br>Switching module; with momentary switch; Switching voltage: 250 VAC; translucent | URL | Download |
|--|-----|----------|

## Installation Notes

Subject to changes. Please also observe the further product documentation!

WAGO GmbH & Co. KG  
Hansastr. 27  
32423 Minden  
Phone: +49571 887-0 | Fax: +49571 887-169  
Email: [info.de@wago.com](mailto:info.de@wago.com) | Web: [www.wago.com](http://www.wago.com)

Do you have any questions about our products?  
We are always happy to take your call at +49 (571) 887-44222.