



3025 MHz Ceramic Band Pass Filter



ANATECH ELECTRONICS INC
RF & Microwave Filters & Products

Part Number: AE3025CB1804

Electrical Specifications

Center Frequency(CF): 3025 MHz
Bandwidth(BW): 120 MHz
Insertion Loss in BW: 2.2 dB Max.
Ripple in BW: 1.0 dB Max.
VSWR in BW: 1.7 :1 Max.
Rejection1: 50 dB Min. @ 2825 MHz
Rejection2: 60 dB Min. @ 3225 MHz
Power Handling: 1 Watt
Input / output Impedance: 50 Ohms

Mechanical

Mounting Method: SMT
Dimensions: 34.4 x 14 x 5.5 mm

Environmental

Operating Temperature: -35°C to +75°C
Storage Temperature: -50°C to +90 °C
Shock: 10G. 11ms
Vibration: 10G 0.5 to 200 Hz

This Product is RoHS Compliant.

Outline Drawing:

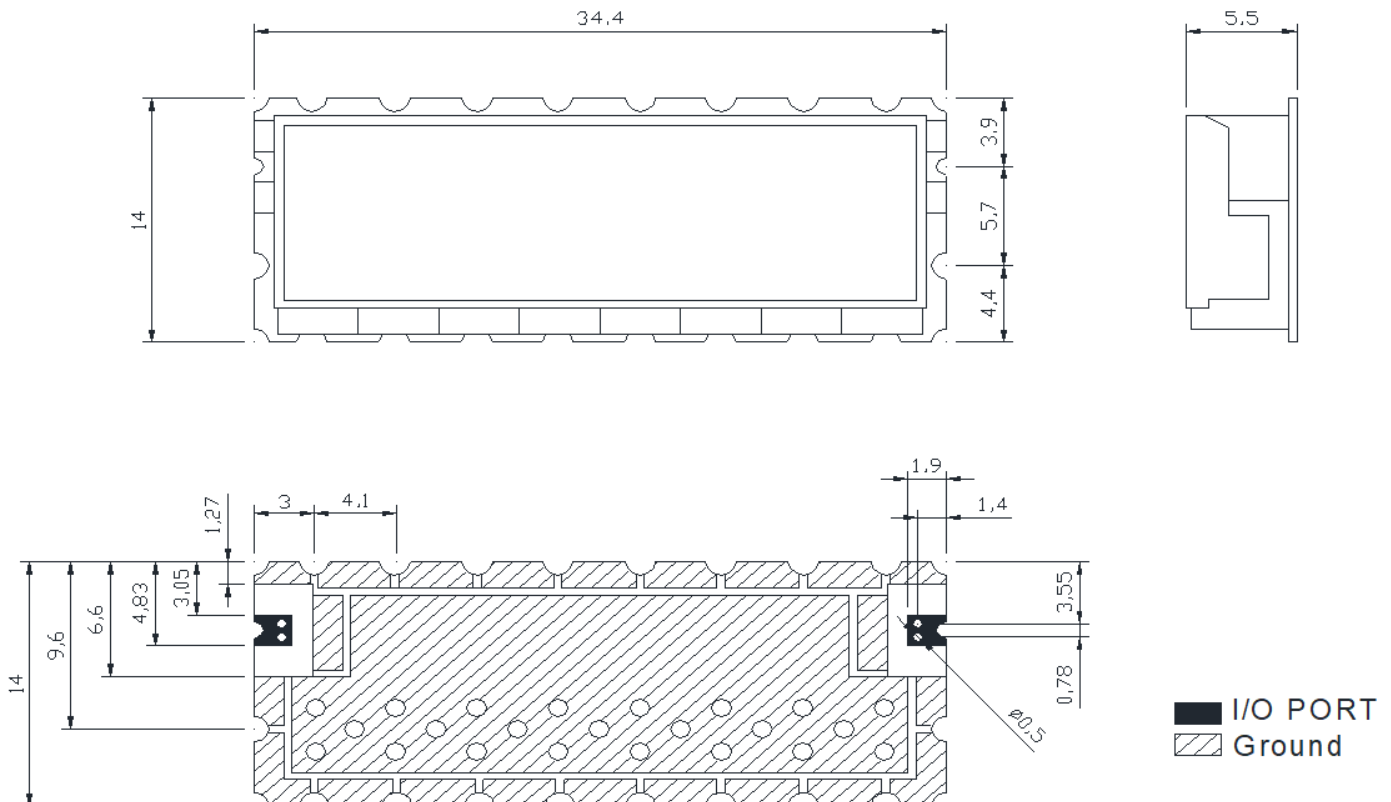

Tolerance: +/-0.01 inches [+/- 0.3mm]

Angles: +/- 1 Deg.

*Tolerance as shown unless otherwise specified in the datasheet electrical specification tables above.

*When max dimensions are called out the above tolerances do not apply as long as it is under the max call out.