

ANT-W63-FPC2-UFL-100 Flexible Embedded WiFi 6 Antenna

The Linx W63-FPC2 antenna is a flexible embedded multiband antenna offering excellent performance for WiFi 6E applications in the 6 GHz band (5.925 GHz to 7.125 GHz) plus 2.4 GHz and 5 GHz WiFi/WLAN for WiFi 5 and WiFi 6 solutions.

The W63-FPC2 provides a ground plane independent dipole embedded antenna solution comparable in performance to an external antenna. The flexibility and adhesive backing makes the W63-FPC2 antenna easy to mount in unique and custom enclosures, while enabling an environmentally sealed enclosure and protection from tampering or accidental antenna damage.

Connection is made to the radio via a 100 mm (3.94 in) long, 1.13 mm coaxial cable terminated in a U.FL-type plug (female socket) connector.



Features

- 2.4 GHz, 5 GHz and 6 GHz WiFi/WLAN bands
- Ground plane independent dipole antenna
- Compact, low-profile
 - 42.0 mm x 12.0 mm x 0.2 mm
- U.FL-type plug (female socket) Compatible with MHF1, AMC, UMCC
- Adhesive backing permanently adheres to non-metal enclosures using 3M 467MP™/200MP adhesive
- Flexible to fit in challenging enclosures

Applications

- Complete WiFi/WLAN coverage
 - 802.11b/g
 - WiFi 4 (802.11n)
 - WiFi 5 (802.11ac)
 - WiFi 6 (802.11ax)
 - WiFi 6E (802.11ax)
- U-NII bands 1-4 and 5-8 (proposed)
- 2.4 GHz ISM applications
 - Bluetooth®
 - ZigBee®
- Internet of Things (IoT) devices
- Smart Home networking
- Sensing and remote monitoring

Ordering Information

Part Number	Description
ANT-W63-FPC2-UFL-100	Antenna with 100 mm of 1.13 mm coaxial cable and U.FL-type plug (female socket)

Available from Linx Technologies and select distributors and representatives.

Electrical Specifications

ANT-W63-FPC2-UFL	ISM/WiFi	U-NII 1-4	U-NII 5-8*
Frequency Range	2400 MHz to 2485 MHz	5150 MHz to 5850 MHz	5925 MHz to 7125 MHz
VSWR (max.)	2.4	1.4	2.4
Peak Gain (dBi)	3.2	7.7	8.4
Average Gain (dBi)	-2.3	-1.6	-2.9
Efficiency (%)	61	72	57
Polarization	Linear		
Radiation	Omnidirectional		
Max Power	2 W		
Wavelength	1/2-wave		
Electrical Type	Dipole		
Impedance	50 Ω		
Connection	U.FL-type plug (female socket) on 100 mm (3.94 in) of 1.13 mm coaxial cable.		
Weight	0.6 g (0.02 oz)		
Dimensions	42.0 mm x 12.0 mm x 0.2 mm (1.65 in x 0.47 in x 0.01 in)		
Operating Temp. Range	-40 °C to +80 °C		

*Proposed

Product Dimensions

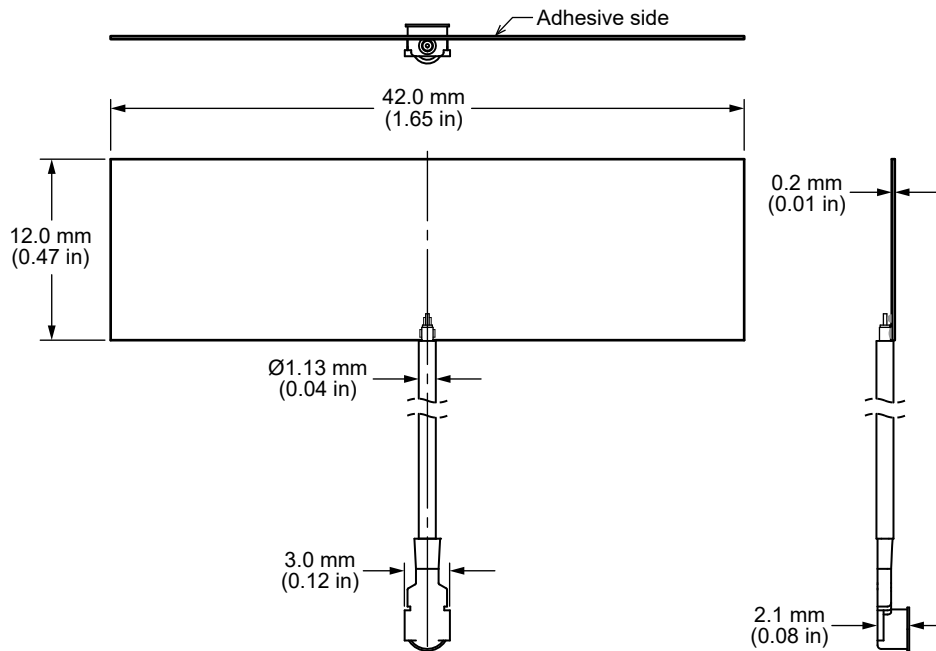

Figure 1. ANT-W63-FPC2-UFL-100 Dimensions

Antenna Mounting

The ANT-W63-FPC2-UFL-100 is a flexible, adhesive backed antenna that allows it to be permanently installed onto non-metallic surfaces. The adhesive backing is 3M 467MP™/200MP, which provides outstanding adhesion to high surface energy plastics. The adhesive delivers excellent shear strength to resist slippage and edge lifting, but can be repositioned temporarily to allow for repositioning. This adhesive is highly resistant to solvents, humidity and moisture, as well as heat up to 204 °C (400 °F) for short periods.

The antenna should never be bent to the point of creating a crease or allowing the angle of the bend to fall below 90 degrees (i.e. become acute) as this will impair function and may cause permanent damage.

VSWR

Figure 2 provides the voltage standing wave ratio (VSWR) across the antenna bandwidth. VSWR describes the power reflected from the antenna back to the radio. A lower VSWR value indicates better antenna performance at a given frequency. Reflected power is also shown on the right-side vertical axis as a gauge of the percentage of transmitter power reflected back from the antenna.

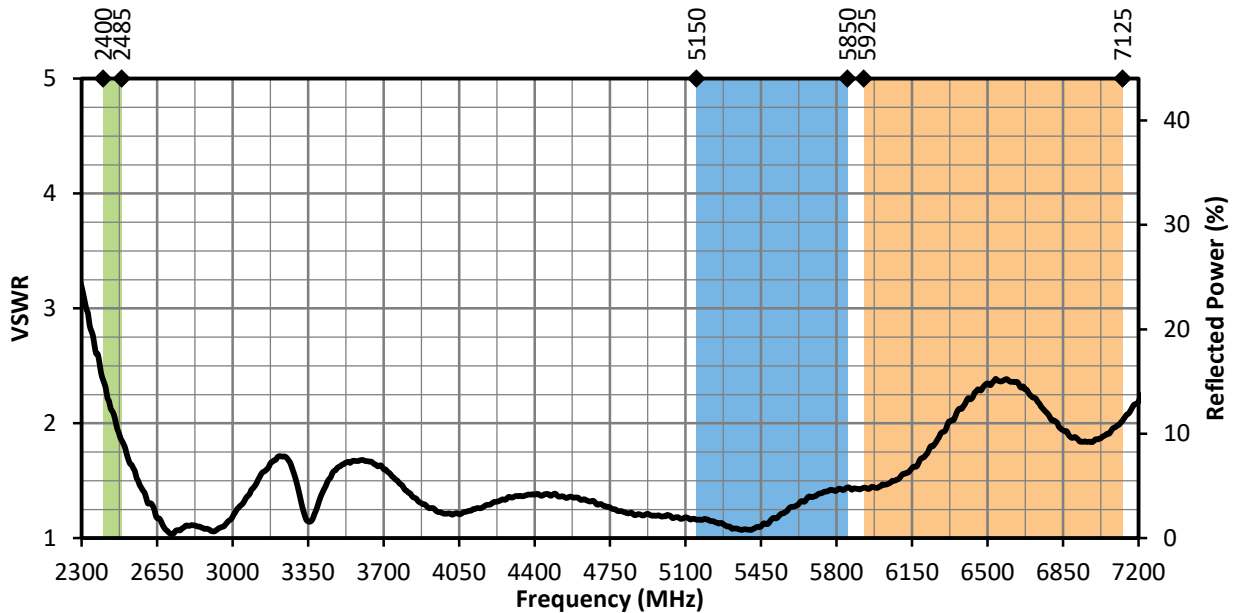

Figure 2. W63-FPC2 Antenna VSWR with Frequency Band Highlights

Return Loss

Return loss (Figure 3), represents the loss in power at the antenna due to reflected signals. Like VSWR, a lower return loss value indicates better antenna performance at a given frequency.

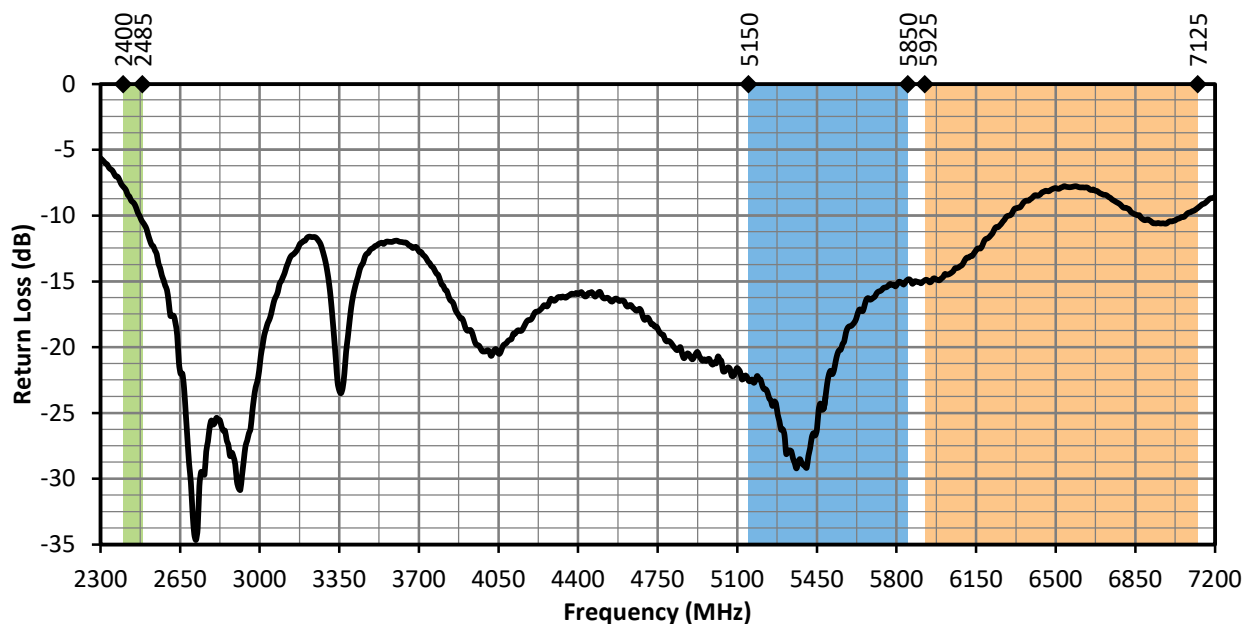

Figure 3. W63-FPC2 Antenna Return Loss with Frequency Band Highlights

Peak Gain

The peak gain across the antenna bandwidth is shown in Figure 4. Peak gain represents the maximum antenna input power concentration across 3-dimensional space, and therefore peak performance, at a given frequency, but does not consider any directionality in the gain pattern.

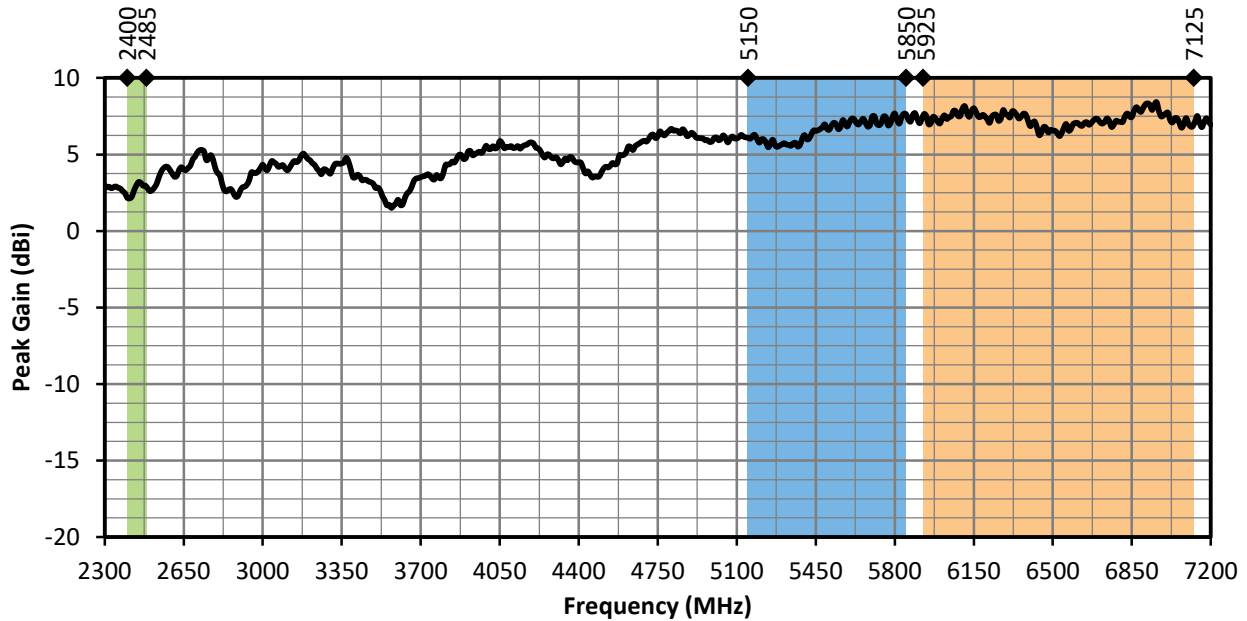

Figure 4. W63-FPC2 Antenna Peak Gain with Frequency Band Highlights

Average Gain

Average gain (Figure 5), is the average of all antenna gain in 3-dimensional space at each frequency, providing an indication of overall performance without expressing antenna directionality.

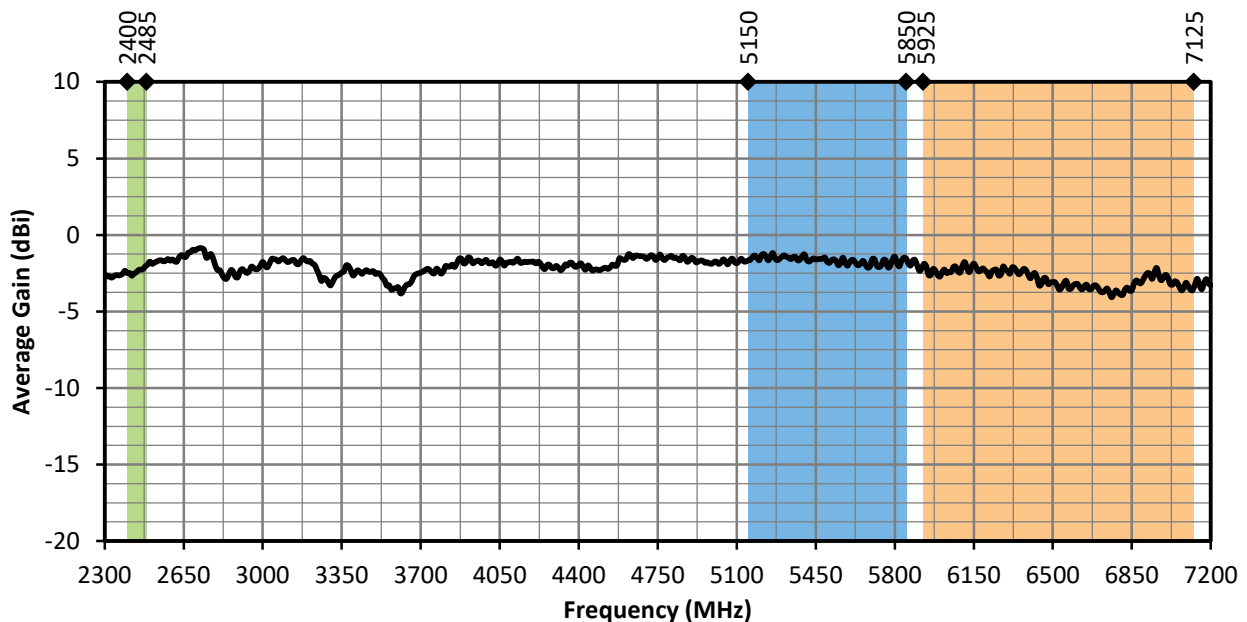

Figure 5. W63-FPC2 Antenna Average Gain with Frequency Band Highlights

Radiation Efficiency

Radiation efficiency (Figure 6), shows the ratio of power delivered to the antenna relative to the power radiated at the antenna, expressed as a percentage, where a higher percentage indicates better performance at a given frequency.

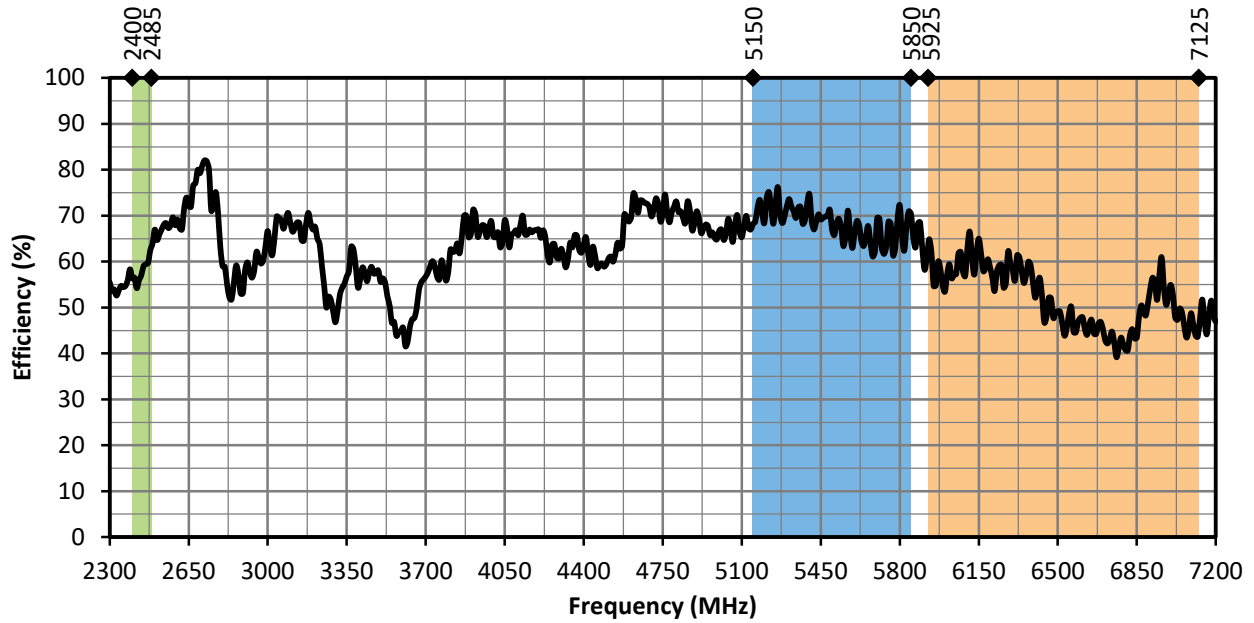
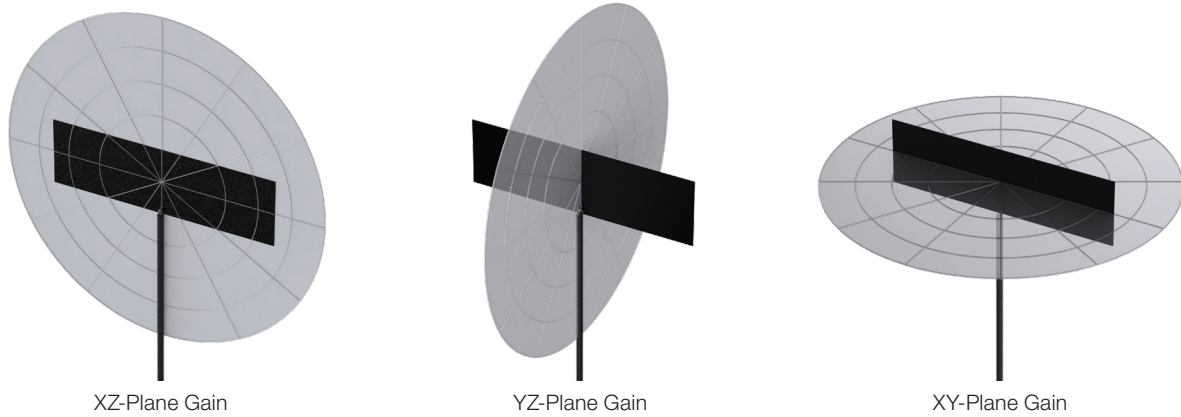

Figure 6. W63-FPC2 Antenna Radiation Efficiency with Frequency Band Highlights

Radiation Patterns

Radiation patterns provide information about the directionality and 3-dimensional gain performance of the antenna by plotting gain at specific frequencies in three orthogonal planes. Antenna radiation patterns (Figure 7), are shown using polar plots covering 360 degrees. The antenna graphic above the plots provides reference to the plane of the column of plots below it. Note: when viewed with typical PDF viewing software, zooming into radiation patterns is possible to reveal fine detail.



2400 MHz to 2485 MHz (2450 MHz)

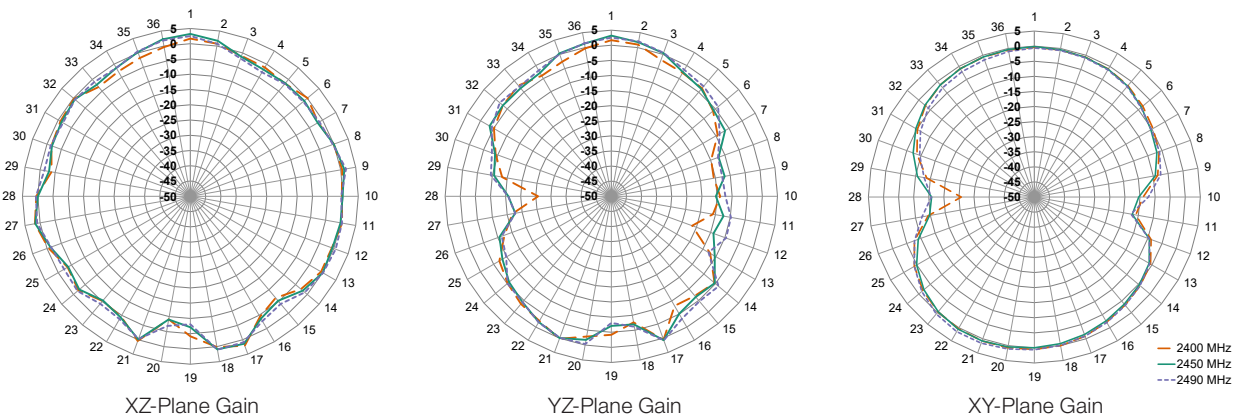

5150 MHz to 5850 MHz (5500 MHz)

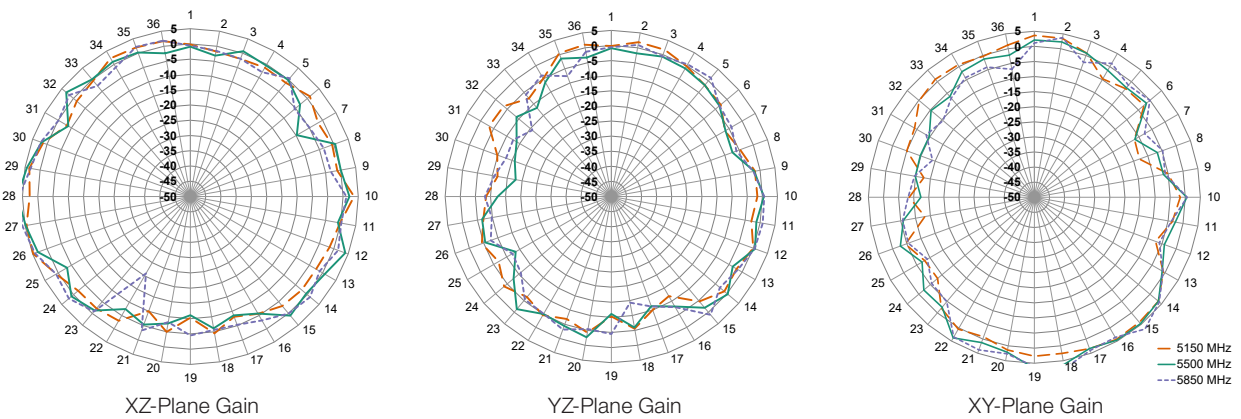

Radiation Patterns

5925 MHz to 7125 MHz (6530 MHz)

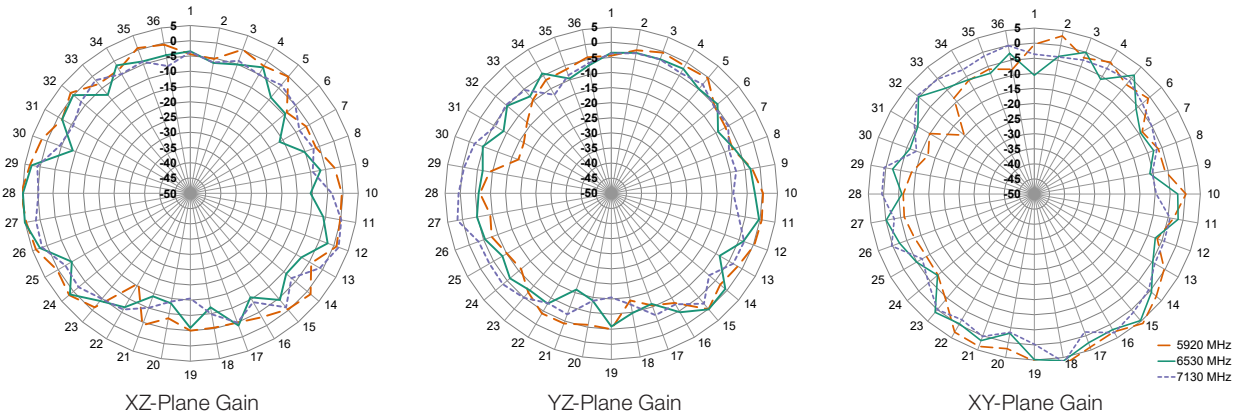

Figure 7. Radiation Patterns for ANT-W63-FPC2-UFL-100 Antenna

Packaging Information

The ANT-W63-FPC2-UFL-100 antennas are packed in a clear bag of 100 pcs. Distribution channels may offer alternative packaging options.

Website: <http://linxtechnologies.com>
Linx Offices: 159 Ort Lane, Merlin, OR, US 97532
Phone: +1 (541) 471-6256
E-MAIL: info@linxtechnologies.com

Linx Technologies reserves the right to make changes to the product(s) or information contained herein without notice. No liability is assumed as a result of their use or application. No rights under any patent accompany the sale of any such product(s) or information.

Wireless Made Simple is a registered trademark of Linx Acquisitions LLC. Bluetooth is a registered trademark of Bluetooth SIG, Inc. ZigBee is a registered trademark of ZigBee Alliance, Inc. Other product and brand names may be trademarks or registered trademarks of their respective owners.

Copyright © 2020 Linx Technologies

All Rights Reserved

Doc# DS20261-98ANT

