

# G9TA

AC Power Latching Relay

## 60 A High power latching relay

- High power switching, Compact size
- High magnetic latching force provides vibration resistance
- Low contact resistance
- PCB terminals type available
- Conforms to UL 508 (Except PCB terminals type)

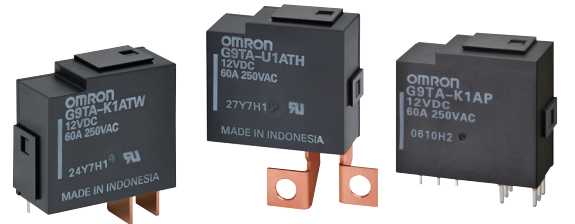

RoHS Compliant

### Model Number Structure

G9TA-□ 1 A □  
1 2 3 4

- Relay Function  
U: Single-winding latching  
K: Double-winding latching
- Number of poles  
1: 1-Pole
- Contact Form  
A: SPST-NO
- Terminal shape  
TH: M5 securing screw  
TW: Welding terminals  
P: PCB terminals

### Application Examples

- Smart Meter
- Lighting control
- PV Inverter
- EV Charger

### Ordering Information

Classification	Contact Form	Terminal Shape	Enclosure rating	Model	Rated coil voltage	Minimum packing unit
Single coil	SPST-NO	M5 securing screw	Flux protection	G9TA-U1ATH	12 VDC	25 pcs/tray
		Welding terminals		G9TA-U1ATW		
		PCB terminals		G9TA-U1AP		
Double coils		M5 securing screw		G9TA-K1ATH	12 VDC	
		Welding terminals		G9TA-K1ATW		
		PCB terminals		G9TA-K1AP		

Note. When ordering, add the rated coil voltage to the model number.

Example: G9TA-U1ATH DC12

Rated coil voltage

However, the notation of the coil voltage on the product case as well as on the packing will be marked as [ ] VDC.

### Ratings

#### ● Coil

##### Single-winding Latching Type

Rated Voltage (V)	Item (V)	Rated current (mA)	Coil resistance (Ω)	Must set voltage	Must reset voltage	Max. voltage	Power consumption	
				% of rated voltage			Set coil (W)	Reset coil (W)
DC	12	83	145	80% max.	80% max.	110% max.	Approx. 1.0	

##### Double-winding Latching Type

Rated Voltage (V)	Item (V)	Rated current (mA)		Coil resistance (Ω)		Must set voltage	Must reset voltage	Max. voltage	Power consumption	
		Set coil	Reset coil	Set coil	Reset coil				Set coil (W)	Reset coil (W)
DC	12	217	217	55	55	80% max.	80% max.	110% max.	Approx. 2.6	Approx. 2.6

Note 1. The rated current and coil resistance were measured at a coil temperature of 23°C with tolerances of ± 10%.

Note 2. The operating characteristics are measured at a coil temperature of 23°C.

Note 3. The maximum permissible voltage is the maximum value of the fluctuation range for the Relay coil operating power supply and was measured at an ambient temperature of 23°C.

#### ● Contacts

Item	Model Load	G9TA-U1A□ /G9TA-K1A□	
		Resistive load	Inductive load (PF=0.5)
Contact type		SPST-NO	
Contact material		Ag Alloy	
Rated load		60 A at 250 VAC	
Rated carry current		60 A	
Max. switching voltage		250 VAC	
Max. switching current		60 A	

## Characteristics

Item		G9TA-U1A□	G9TA-K1A□
Contact resistance *1		2 mΩ max.	
Set time *2		30 ms max.	20 ms max.
Reset time *2		30 ms max.	20 ms max.
Minimum pulse width		100 ms	
Maximum pulse width		1,000 ms	
Insulation resistance *3		1,000 MΩ min.	
Dielectric strength	Between coil and contacts	4,000 VAC, 50/60 Hz for 1 min	
	Between contacts of the same polarity	1,500 VAC, 50/60 Hz for 1 min	
Impulse withstand voltage	Between coil and contacts	6 kV	
Vibration resistance	Destruction	10 to 150 to 10 Hz, f < 60 Hz: Constant amplitude 0.075 mm, f > 60 Hz: Constant acceleration 9.8 m/s <sup>2</sup>	
	Malfunction	10 to 55 to 10 Hz, 0.75 mm single amplitude (1.5 mm double amplitude)	
Shock resistance	Destruction	1,000 m/s <sup>2</sup>	
	Malfunction	100 m/s <sup>2</sup>	
Durability	Mechanical	100,000 operations min. (at 7,200 operations/h)	
	Electrical *4	5,000 operations, resistive load and then 5,000 operations, inductive load (PF=0.5) (operation: ON for 10 sec, OFF for 20 sec) *5	
Ambient operating temperature		-40 to 85°C (with no icing or condensation)	
Ambient operating humidity		5 to 85%	
Weight		Approx. 42 g	

Note. The values given above are initial values.

\*1. Measurement conditions: 24 VDC, 1 A, voltage drop method.

\*2. Measurement conditions: Rated operating voltage applied, not including contact bounce.  
Ambient temperature: 23°C

\*3. Measurement conditions: The insulation resistance was measured with a 500 VDC megohm meter at the same locations as the dielectric strength was measured.

\*4. Contact your OMRON sales representative for Electrical Durability technical data.

\*5. The characteristic meets IEC62055-31 test requirement.

### Dimensions

**CAD Data** Please visit our website, which is noted on the last page.

(Unit: mm)

#### G9TA-U1ATH

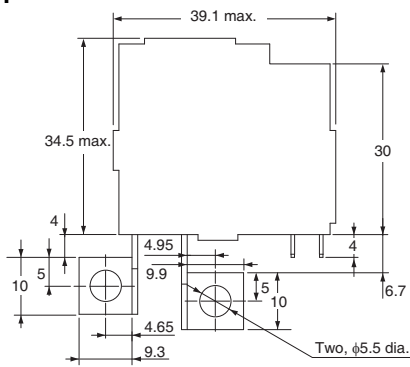

**Terminal arrangement/Internal Connections (TOP VIEW)**

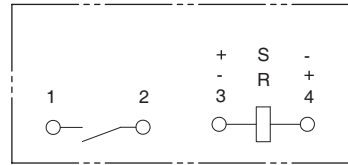

Check carefully the coil polarity of the Relay.

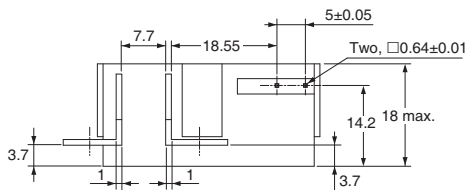

**CAD Data**

#### G9TA-U1ATW

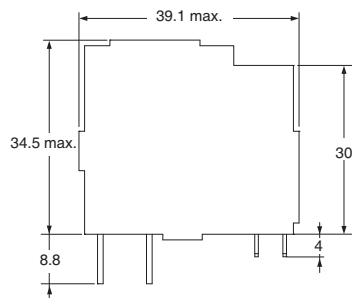

**Terminal arrangement/Internal Connections (TOP VIEW)**

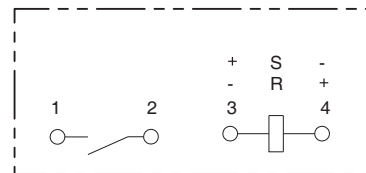

Check carefully the coil polarity of the Relay.

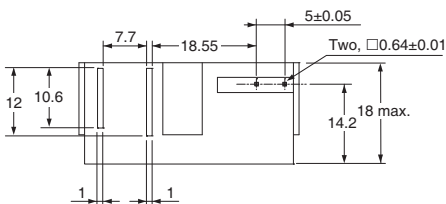

**CAD Data**

#### G9TA-U1AP

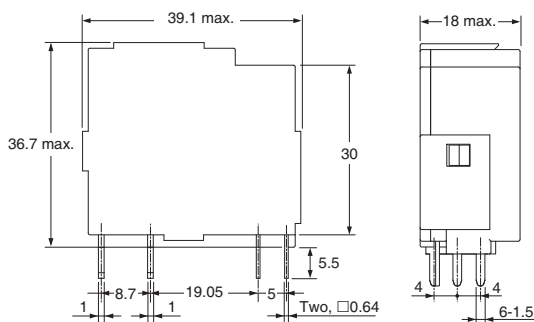

**PCB Mounting Holes (BOTTOM VIEW)**

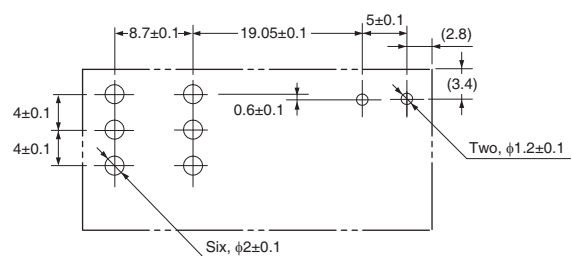

**Terminal arrangement/Internal Connection (BOTTOM VIEW)**

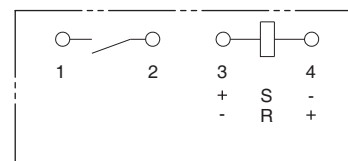

Check carefully the coil polarity of the Relay.

**CAD Data**

## G9TA-K1ATH

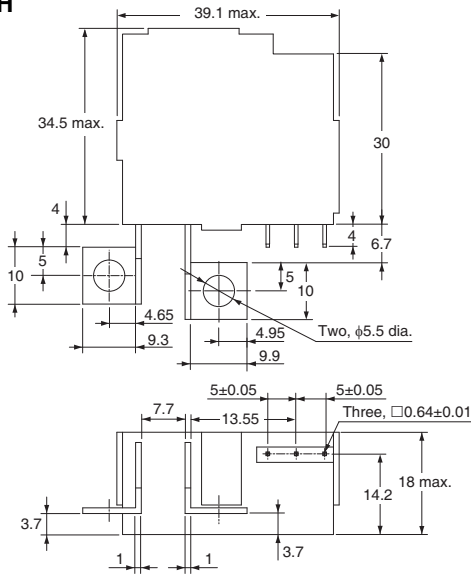

Terminal arrangement/Internal Connections  
(TOP VIEW)

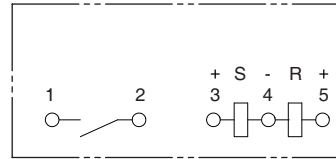

Check carefully the coil polarity of the Relay.

CAD Data

## G9TA-K1ATW

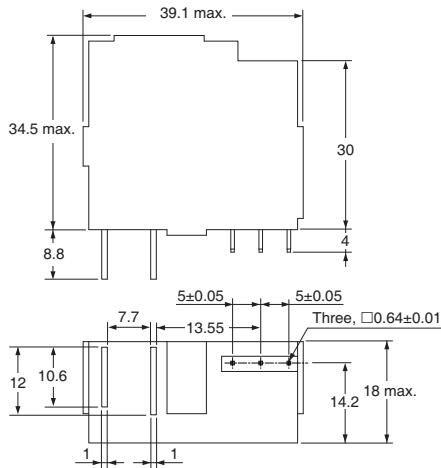

Terminal arrangement/Internal Connections  
(TOP VIEW)

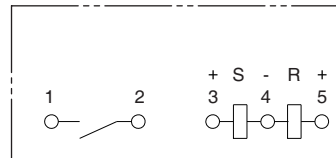

Check carefully the coil polarity of the Relay.

CAD Data

## G9TA-K1AP

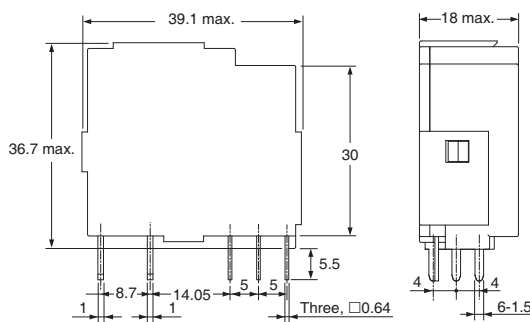

PCB Mounting Holes  
(BOTTOM VIEW)

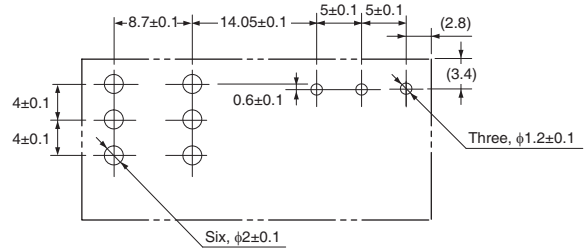

Terminal arrangement/Internal Connections  
(BOTTOM VIEW)

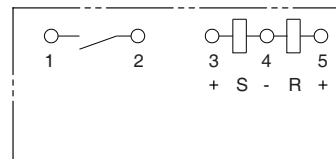

Check carefully the coil polarity of the Relay.

CAD Data

Note 1. Relay is delivered as "reset" status unless specified otherwise. However, the status may change due to the shock from transportation or mounting operations.

Therefore, it is recommended the relay should be set to the expected status via a power supply before being used.

Note 2. In order to maintain "set" or "reset" status, the energizing voltage to coil & the pulse width shouldn't lower than the rated value.

Note 3. Do not energize both of set and reset coil simultaneously.

Note 4. Energizing time longer than 1,000 ms should be avoided.

## Engineering Data

### ● Maximum Switching Capacity

G9TA-U1A□

G9TA-K1A□

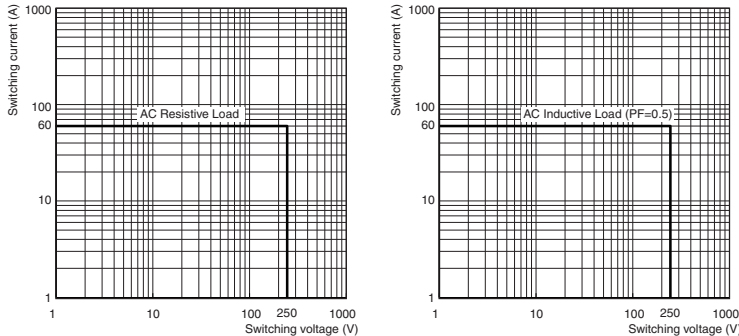

## Approved Standards

The approval rating values for overseas standards are different from the performance values determined individually. Confirm the values before use.

● UL Recognized:  (File No. E41515)

Model	Contact form	Coil ratings	Contact ratings	Number of test operations
G9TA-U1ATH G9TA-U1ATW G9TA-K1ATW G9TA-K1ATH	SPST-NO (1a)	12V DC	60 A, 277 V AC (Resistive) 70°C 60 A, 250 V AC (Resistive) and then 60 A, 250 V (PF=0.5), 10 sec. ON / 20 sec. OFF, 40°C	6,000 5,000 for resistive and then 5,000 for PF=0.5

## Safety Precautions

● Please refer to "PCB Relays Common Precautions" for correct use.

Correct Use

### ● Installation

- The relay contacts are polarized. Incorrect wiring may cause a failure to break the circuit. Wire the Relay with care.
- Install the Relays in locations that are as dry as possible and have as little dust, dirt, and harmful gas.
- Using the Relay under high temperature, high humidity, or harmful gas may deteriorate its performance characteristics due to condensation or corrosive materials, resulting in failure or burn damage to the Relay.

### ● Wiring

- Be sure to tighten all screws to the appropriate torque given below.
- Loose screws may result in burning due to abnormal heat generation during energization.
- M5 screws: 1.57 to 2.35 N·m
- Use a spring washer in order to prevent deformation and looseness.
- Allow suitable slack on leads when wiring, and do not apply excessive force to the terminals.

Please check each region's Terms & Conditions by region website.

### ● Relay Service Life

- The electrical durability of these Relays is specified as the number of load switching operations under a resistive load and OMRON-specified standard testing conditions. The coil drive circuit, ambient environment, switching frequency, or load conditions (e.g., inductive load or capacitor load) may reduce the service life and possibly lead to failure to break. Always confirm the service life in the actual equipment.

## OMRON Corporation

Electronic and Mechanical Components Company

### Regional Contact

#### Americas

<https://www.components.omron.com/>

#### Asia-Pacific

<https://ecb.omron.com.sg/>

#### Korea

<https://www.omron-ecb.co.kr/>

#### Europe

<http://components.omron.eu/>

#### China

<https://www.ecb.omron.com.cn/>

#### Japan

<https://www.omron.co.jp/ecb/>