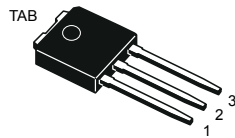
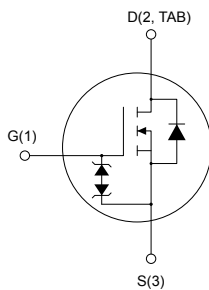

N-channel 1000 V, 6.25 Ω typ., 1.85 A SuperMESH Power MOSFET in an IPAK package

IPAK

AM01476v1_tab

Product status link
[STU2NK100Z](#)
Product summary

Order code	STU2NK100Z
Marking	2NK100Z
Package	IPAK
Packing	Tube

Features

Order code	V_{DS}	$R_{DS(on)}$ max.	I_D
STU2NK100Z	1000 V	8.5 Ω	1.85 A

- 100% avalanche tested
- Gate charge minimized
- Very low intrinsic capacitance
- Zener-protected

Applications

- Switching applications

Description

This high-voltage device is a Zener-protected N-channel Power MOSFET developed using the SuperMESH technology by STMicroelectronics, an optimization of the well-established PowerMESH. In addition to a significant reduction in on-resistance, this device is designed to ensure a high level of dv/dt capability for the most demanding applications.

1 Electrical ratings

Table 1. Absolute maximum ratings

Symbol	Parameter	Value	Unit
V_{DS}	Drain-source voltage	1000	V
V_{GS}	Gate-source voltage	±30	V
I_D	Drain current (continuous) at $T_C = 25\text{ °C}$	1.85	A
	Drain current (continuous) at $T_C = 100\text{ °C}$	1.6	
$I_{DM}^{(1)}$	Drain current (pulsed)	7.4	A
P_{TOT}	Total power dissipation at $T_C = 25\text{ °C}$	70	W
ESD	Gate-source, human body model ($R = 1.5\text{ k}\Omega$, $C = 100\text{ pF}$)	3	kV
$dv/dt^{(2)}$	Peak diode recovery voltage slope	2.5	V/ns
T_{stg}	Storage temperature range	-55 to 150	°C
T_J	Operating junction temperature range		°C

1. Pulse width limited by safe operating area.

2. $I_{SD} \leq 1.85\text{ A}$, $di/dt \leq 200\text{ A}/\mu\text{s}$, $V_{DD} = 80\% V_{(BR)DSS}$.

Table 2. Thermal data

Symbol	Parameter	Value	Unit
R_{thJC}	Thermal resistance, junction-to-case	1.79	°C/W
R_{thJA}	Thermal resistance, junction-to-ambient	100	°C/W

Table 3. Avalanche characteristics

Symbol	Parameter	Value	Unit
I_{AR}	Avalanche current, repetitive or not repetitive (pulse width is limited by T_J max.)	1.85	A
E_{AS}	Single pulse avalanche energy (starting $T_J = 25\text{ °C}$, $I_D = I_{AR}$, $V_{DD} = 50\text{ V}$)	170	mJ

2 Electrical characteristics

$T_C = 25\text{ }^\circ\text{C}$ unless otherwise specified.

Table 4. On/off states

Symbol	Parameter	Test conditions	Min.	Typ.	Max.	Unit
$V_{(BR)DSS}$	Drain-source breakdown voltage	$V_{GS} = 0\text{ V}$, $I_D = 1\text{ mA}$	1000			V
I_{DSS}	Zero gate voltage drain current	$V_{GS} = 0\text{ V}$, $V_{DS} = 1000\text{ V}$			1	μA
		$V_{GS} = 0\text{ V}$, $V_{DS} = 1000\text{ V}$, $T_C = 125\text{ }^\circ\text{C}^{(1)}$			50	μA
I_{GSS}	Gate-body leakage current	$V_{DS} = 0\text{ V}$, $V_{GS} = \pm 30\text{ V}$			± 10	μA
$V_{GS(th)}$	Gate threshold voltage	$V_{DS} = V_{GS}$, $I_D = 50\text{ }\mu\text{A}$	3	3.75	4.5	V
$R_{DS(on)}$	Static drain-source on resistance	$V_{GS} = 10\text{ V}$, $I_D = 0.9\text{ A}$		6.25	8.5	Ω

1. Specified by design, not tested in production.

Table 5. Dynamic

Symbol	Parameter	Test conditions	Min.	Typ.	Max.	Unit
C_{iss}	Input capacitance	$V_{DS} = 25\text{ V}$, $f = 1\text{ MHz}$, $V_{GS} = 0\text{ V}$	-	499	-	pF
C_{oss}	Output capacitance		-	53	-	pF
C_{rss}	Reverse transfer capacitance		-	9	-	pF
$C_{oss\text{ eq.}}^{(1)}$	Equivalent output capacitance	$V_{GS} = 0\text{ V}$, $V_{DS} = 0\text{ V to } 800\text{ V}$	-	28	-	pF
R_G	Gate input resistance	$f = 1\text{ MHz}$, open drain	-	6.6	-	Ω
Q_g	Total gate charge	$V_{DD} = 800\text{ V}$, $I_D = 1.85\text{ A}$, $V_{GS} = 0\text{ to } 10\text{ V}$ (see Figure 14. Test circuit for gate charge behavior)	-	16	-	nC
Q_{gs}	Gate-source charge		-	3	-	nC
Q_{gd}	Gate-drain charge		-	9	-	nC

1. $C_{oss\text{ eq.}}$ is defined as a constant equivalent capacitance giving the same charging time as C_{oss} when V_{DS} increases from 0 to 80% V_{DSS} .

Table 6. Switching times

Symbol	Parameter	Test conditions	Min.	Typ.	Max.	Unit
$t_{d(on)}$	Turn-on delay time	$V_{DD} = 500\text{ V}$, $I_D = 0.9\text{ A}$, $R_G = 4.7\text{ }\Omega$, $V_{GS} = 10\text{ V}$	-	7.2	-	ns
t_r	Rise time		-	6.5	-	ns
$t_{d(off)}$	Turn-off delay time	(see Figure 13. Test circuit for resistive load switching times and Figure 18. Switching time waveform)	-	41.5	-	ns
t_f	Fall time		-	32.5	-	ns

Table 7. Source-drain diode

Symbol	Parameter	Test conditions	Min.	Typ.	Max.	Unit
I_{SD}	Source-drain current		-		1.85	A
$I_{SDM}^{(1)}$	Source-drain current (pulsed)		-		7.4	A
$V_{SD}^{(2)}$	Forward on voltage	$I_{SD} = 1.85\text{ A}$, $V_{GS} = 0\text{ V}$	-		1.6	V
t_{rr}	Reverse recovery time	$I_{SD} = 1.85\text{ A}$, $di/dt = 100\text{ A}/\mu\text{s}$	-	476		ns
Q_{rr}	Reverse recovery charge	$V_{DD} = 60\text{ V}$	-	1.6		μC
I_{RRM}	Reverse recovery current	(see Figure 15. Test circuit for inductive load switching and diode recovery times)	-	6.9		A
t_{rr}	Reverse recovery time	$I_{SD} = 1.85\text{ A}$, $di/dt = 100\text{ A}/\mu\text{s}$	-	532		ns
Q_{rr}	Reverse recovery charge	$V_{DD} = 60\text{ V}$, $T_J = 150\text{ }^\circ\text{C}$	-	1.9		μC
I_{RRM}	Reverse recovery current	(see Figure 15. Test circuit for inductive load switching and diode recovery times)	-	88		A

1. Pulse width is limited by safe operating area.
2. Pulsed: pulse duration = 300 μs , duty cycle 1.5%.

2.1 Electrical characteristics (curves)

Figure 1. Safe operating area

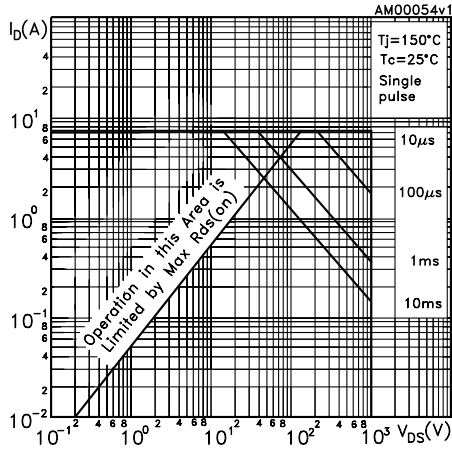

Figure 2. Thermal impedance

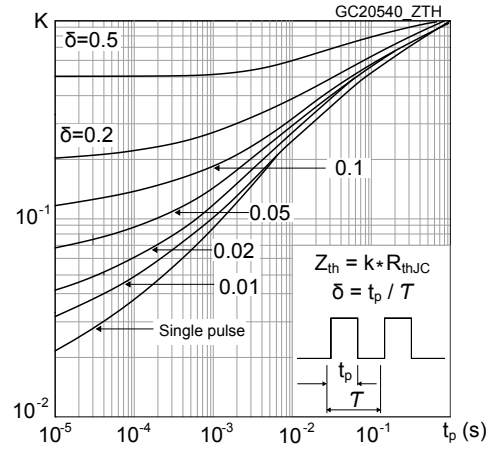

Figure 3. Output characteristics

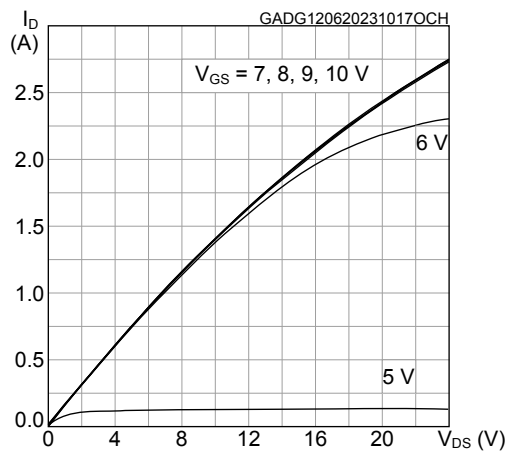

Figure 4. Transfer characteristics

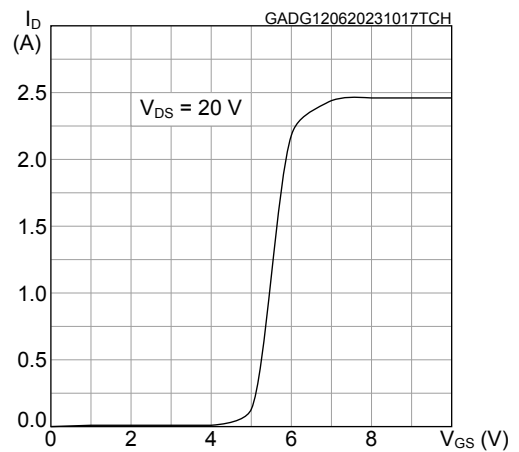

Figure 5. Normalized V_{(BR)DSS} vs temperature

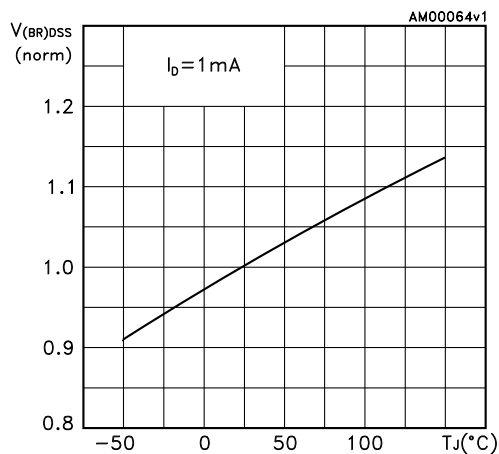

Figure 6. Static drain-source on resistance

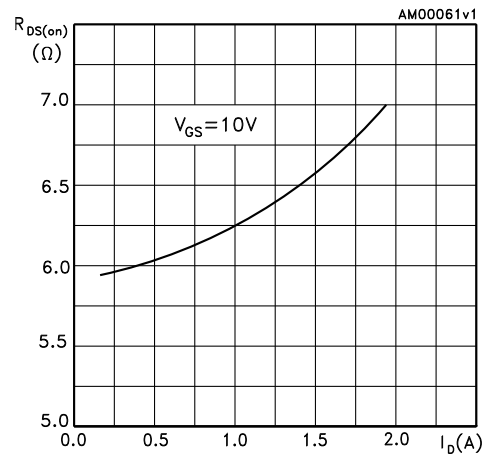

Figure 7. Gate charge vs gate-source voltage

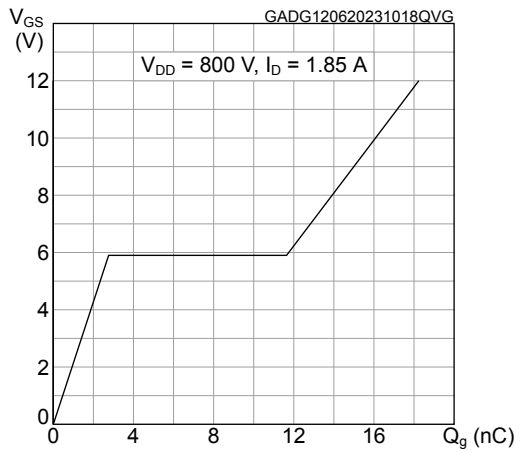

Figure 8. Capacitance variations

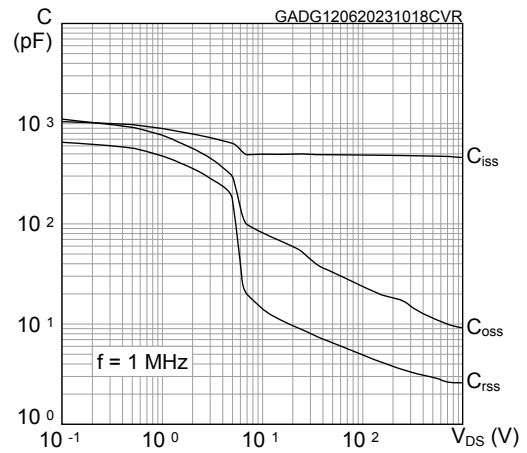

Figure 9. Normalized gate threshold voltage vs temperature

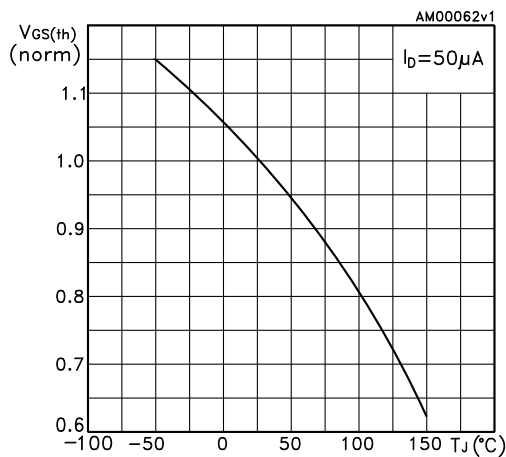

Figure 10. Normalized on resistance vs temperature

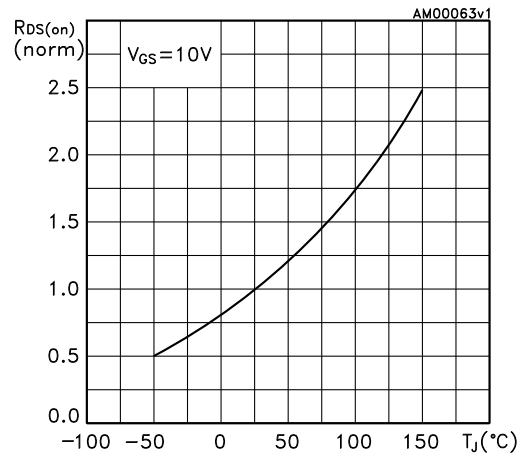

Figure 11. Source-drain diode forward characteristics

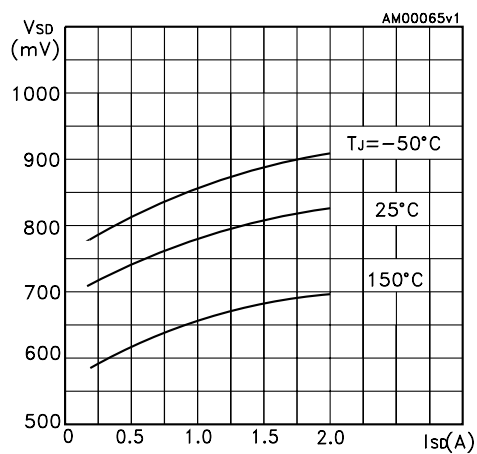
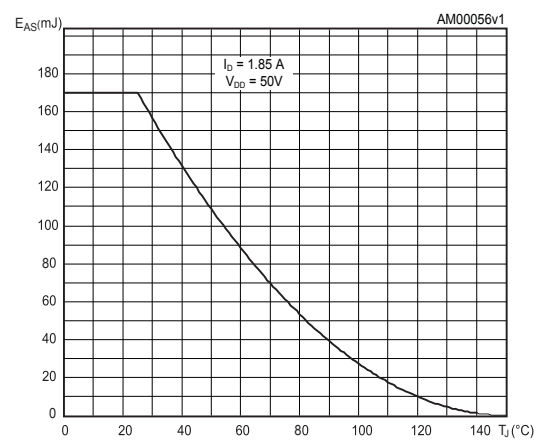

Figure 12. Maximum avalanche energy vs temperature



3 Test circuits

Figure 13. Test circuit for resistive load switching times

AM01468v1

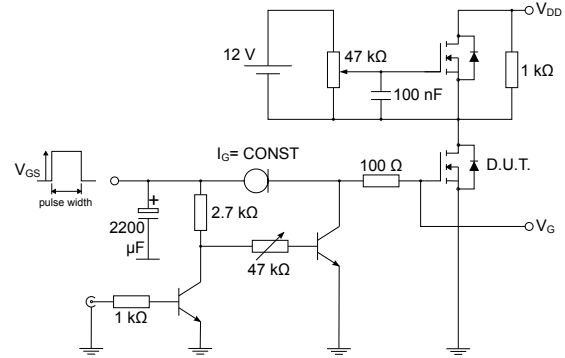
Figure 14. Test circuit for gate charge behavior

AM01469v1

Figure 15. Test circuit for inductive load switching and diode recovery times



AM01470v1

Figure 16. Unclamped inductive load test circuit

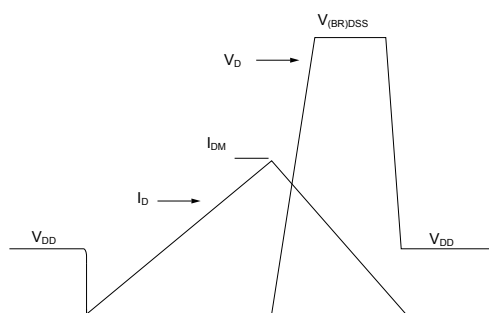
AM01471v1

Figure 17. Unclamped inductive waveform

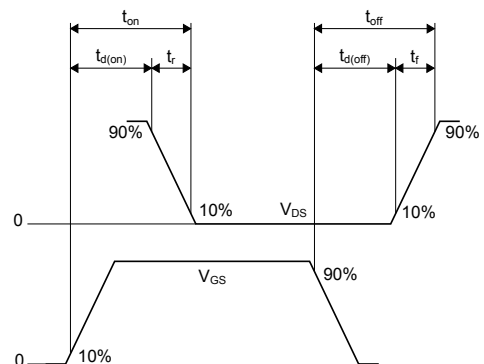
AM01472v1

Figure 18. Switching time waveform

AM01473v1

4 Package information

In order to meet environmental requirements, ST offers these devices in different grades of **ECOPACK** packages, depending on their level of environmental compliance. ECOPACK specifications, grade definitions and product status are available at: www.st.com. ECOPACK is an ST trademark.

4.1 IPAK (TO-251) type E package information

Figure 19. IPAK (TO-251) type E package outline

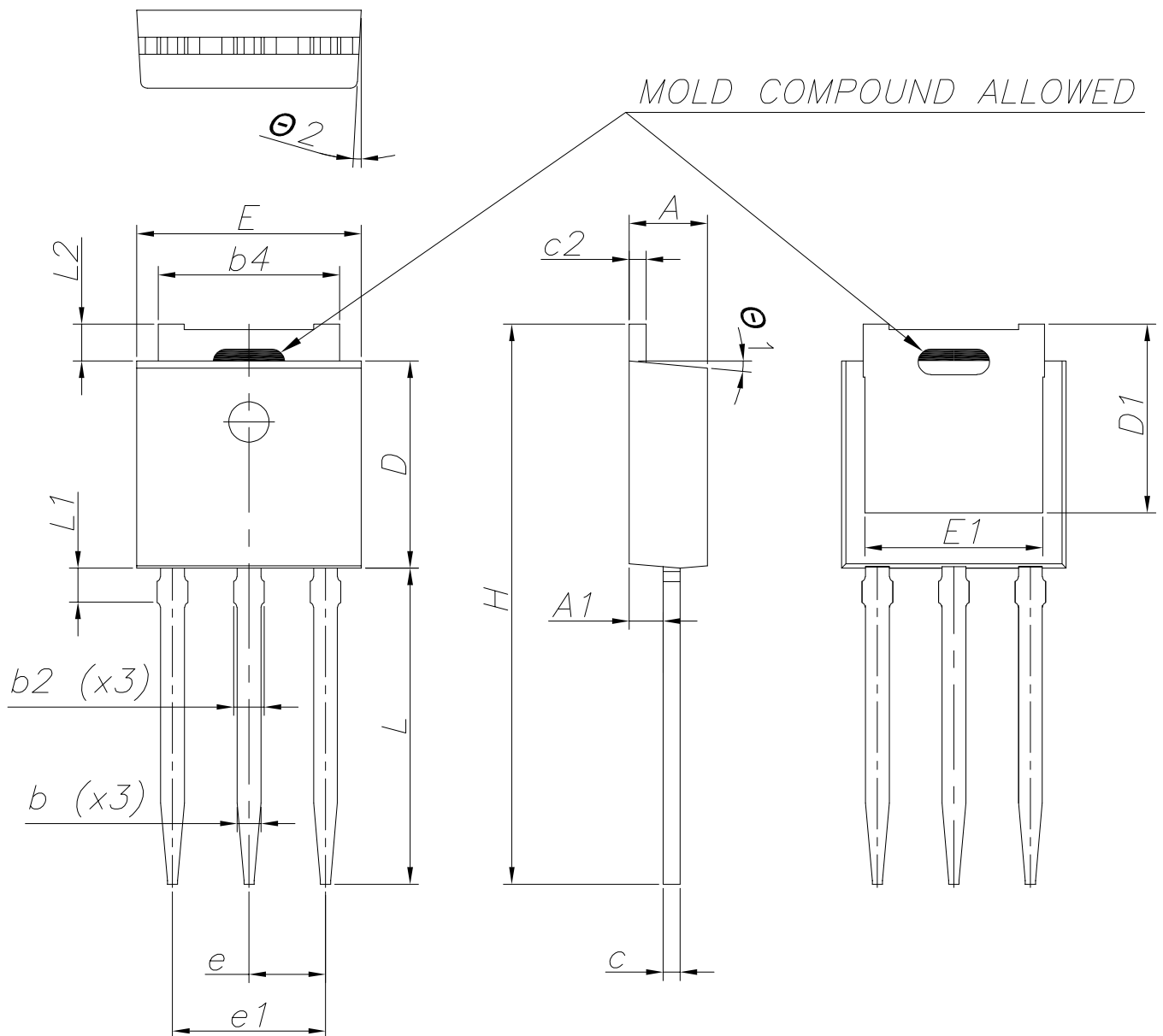

Table 8. IPAK (TO-251) type E package mechanical data

Dim.	mm		
	Min.	Typ.	Max.
A	2.20	2.30	2.35
A1	0.90	1.00	1.10
b	0.66		0.79
b2			0.90
b4	5.23	5.33	5.43
c	0.46		0.59
c2	0.46		0.59
D	6.00	6.10	6.20
D1	5.30	5.53	5.75
E	6.50	6.60	6.70
E1	5.05	5.23	5.40
e	2.20	2.25	2.30
e1	4.40	4.50	4.60
H	16.18	16.48	16.78
L	9.00	9.30	9.60
L1	0.80	1.00	1.20
L2	0.90	1.08	1.25
Ø1	3°	5°	7°
Ø2	1°	3°	5°

Revision history

Table 9. Document revision history

Date	Revision	Changes
24-Oct-2007	1	First release
18-Jun-2008	2	<ul style="list-style-type: none"> – Inserted new package, mechanical data IPAK – Document status promoted from preliminary data to datasheet.
28-Jun-2018	3	<p>Removed maturity status indication from cover page. The document status is production data.</p> <p>Updated title in cover page, <i>Section 1 Electrical ratings</i>, <i>Section 2 Electrical characteristics</i> and <i>Section 4 Package information</i>.</p> <p>Minor text changes.</p>
15-Jun-2023	4	<p>The part numbers STD2NK100Z and STP2NK100Z have been moved to a separate datasheet and the document has been updated accordingly.</p> <p>Removed "<i>Table 8. Gate-source Zener diode</i>".</p> <p>Updated Figure 3. Output characteristics, Figure 4. Transfer characteristics, Figure 7. Gate charge vs gate-source voltage and Figure 8. Capacitance variations.</p> <p>Removed "<i>Section 4.5 IPAK (TO-251) type A package information</i>" and added Section 4.1 IPAK (TO-251) type E package information.</p> <p>Minor text changes.</p>

Contents

1	Electrical ratings	2
2	Electrical characteristics	3
2.1	Electrical characteristics (curves)	5
3	Test circuits	7
4	Package information	8
4.1	IPAK (TO-251) type E package information	8
	Revision history	10

IMPORTANT NOTICE – READ CAREFULLY

STMicroelectronics NV and its subsidiaries (“ST”) reserve the right to make changes, corrections, enhancements, modifications, and improvements to ST products and/or to this document at any time without notice. Purchasers should obtain the latest relevant information on ST products before placing orders. ST products are sold pursuant to ST’s terms and conditions of sale in place at the time of order acknowledgment.

Purchasers are solely responsible for the choice, selection, and use of ST products and ST assumes no liability for application assistance or the design of purchasers’ products.

No license, express or implied, to any intellectual property right is granted by ST herein.

Resale of ST products with provisions different from the information set forth herein shall void any warranty granted by ST for such product.

ST and the ST logo are trademarks of ST. For additional information about ST trademarks, refer to www.st.com/trademarks. All other product or service names are the property of their respective owners.

Information in this document supersedes and replaces information previously supplied in any prior versions of this document.

© 2023 STMicroelectronics – All rights reserved