

N-channel 650 V, 19.9 mΩ typ., 95 A MDmesh M9 Power MOSFET in a TO-247 long leads package

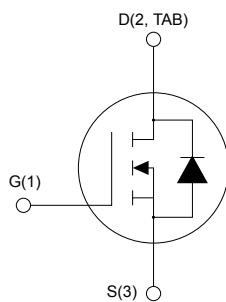

AM01475v1_noZen

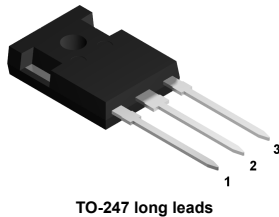

Features

Order code	V _{DS}	R _{DS(on)} max.	I _D
STWA65N023M9	650 V	23.0 mΩ	95

- Worldwide best FOM R_{DS(on)}*Q_g among silicon-based devices
- Higher V_{DSS} rating
- Higher dv/dt capability
- Excellent switching performance
- Easy to drive
- 100% avalanche tested

Applications

- High efficiency switching applications

Description

This N-channel Power MOSFET is based on the most innovative super-junction MDmesh M9 technology, suitable for medium/high voltage MOSFETs featuring very low R_{DS(on)} per area. The silicon based M9 technology benefits from a multi-drain manufacturing process which allows an enhanced device structure. The resulting product has one of the lower on-resistance and reduced gate charge values, among all silicon based fast switching super-junction Power MOSFETs, making it particularly suitable for applications that require superior power density and outstanding efficiency.

Product status link

[STWA65N023M9](#)

Product summary

Order code	STWA65N023M9
Marking	65N023M9
Package	TO-247 long leads
Packing	Tube

1 Electrical ratings

Table 1. Absolute maximum ratings

Symbol	Parameter	Value	Unit
V_{GS}	Gate-source voltage	±30	V
$I_D^{(1)}$	Drain current (continuous) at $T_C = 25\text{ °C}$	95	A
	Drain current (continuous) at $T_C = 100\text{ °C}$	60	
$I_{DM}^{(2)}$	Drain current (pulsed)	440	A
P_{TOT}	Total power dissipation at $T_C = 25\text{ °C}$	463	W
$dv/dt^{(3)}$	Peak diode recovery voltage slope	50	V/ns
$di/dt^{(3)}$	Peak diode recovery current slope	900	A/μs
$dv/dt^{(4)}$	MOSFET dv/dt ruggedness	120	V/ns
T_{stg}	Storage temperature range	-55 to 150	°C
T_J	Operating junction temperature range		°C

1. Referred to TO-247 package.
2. Pulse width is limited by safe operating area.
3. $I_{SD} \leq 48\text{ A}$, $V_{DS} (\text{peak}) < V_{(BR)DSS}$, $V_{DD} = 400\text{ V}$.
4. $V_{DS} (\text{peak}) < V_{(BR)DSS}$, $V_{DD} = 400\text{ V}$.

Table 2. Thermal data

Symbol	Parameter	Value	Unit
R_{thJC}	Thermal resistance, junction-to-case	0.27	°C/W
R_{thJA}	Thermal resistance, junction-to-ambient	50	°C/W

Table 3. Avalanche characteristics

Symbol	Parameter	Value	Unit
I_{AR}	Avalanche current, repetitive or non-repetitive (pulse width limited by T_J max.)	12	A
E_{AS}	Single pulse avalanche energy (starting $T_J = 25\text{ °C}$, $I_D = I_{AR}$, $V_{DD} = 50\text{ V}$)	1307	mJ

2 Electrical characteristics

$T_C = 25\text{ °C}$ unless otherwise specified.

Table 4. On-/off-states

Symbol	Parameter	Test conditions	Min.	Typ.	Max.	Unit
$V_{(BR)DSS}$	Drain-source breakdown voltage	$V_{GS} = 0\text{ V}$, $I_D = 1\text{ mA}$	650			V
I_{DSS}	Zero gate voltage drain current	$V_{GS} = 0\text{ V}$, $V_{DS} = 650\text{ V}$			1	μA
		$V_{GS} = 0\text{ V}$, $V_{DS} = 650\text{ V}$, $T_C = 125\text{ °C}^{(1)}$			200	
I_{GSS}	Gate-body leakage current	$V_{DS} = 0\text{ V}$, $V_{GS} = \pm 25\text{ V}$			± 100	nA
$V_{GS(th)}$	Gate threshold voltage	$V_{DS} = V_{GS}$, $I_D = 250\text{ }\mu\text{A}$	3.2	3.7	4.2	V
$R_{DS(on)}$	Static drain-source on-resistance	$V_{GS} = 10\text{ V}$, $I_D = 48\text{ A}$		19.9	23.0	m Ω

1. Specified by design, not tested in production.

Table 5. Dynamic

Symbol	Parameter	Test conditions	Min.	Typ.	Max.	Unit
C_{iss}	Input capacitance	$V_{DS} = 400\text{ V}$, $f = 1\text{ MHz}$, $V_{GS} = 0\text{ V}$	-	8844	-	pF
C_{oss}	Output capacitance		-	140	-	pF
$C_{oss\text{ eq.}}^{(1)}$	Equivalent output capacitance	$V_{DS} = 0\text{ to }400\text{ V}$, $V_{GS} = 0\text{ V}$	-	1750	-	pF
R_G	Intrinsic gate resistance	$f = 1\text{ MHz}$, open drain	-	0.8	-	Ω
Q_g	Total gate charge	$V_{DD} = 400\text{ V}$, $I_D = 48\text{ A}$, $V_{GS} = 0\text{ to }10\text{ V}$ (see Figure 15. Test circuit for gate charge behavior)	-	230	-	nC
Q_{gs}	Gate-source charge		-	52	-	nC
Q_{gd}	Gate-drain charge		-	108	-	nC

1. $C_{oss\text{ eq.}}$ is defined as a constant equivalent capacitance giving the same charging time as C_{oss} when V_{DS} increases from 0 to stated value.

Table 6. Switching times

Symbol	Parameter	Test conditions	Min.	Typ.	Max.	Unit
$t_{d(v)}$	Voltage delay time	$V_{DD} = 400\text{ V}$, $I_D = 48\text{ A}$, $R_G = 4.7\text{ }\Omega$, $V_{GS} = 10\text{ V}$	-	140	-	ns
$t_{r(v)}$	Voltage rise time		-	4	-	ns
$t_{f(i)}$	Current fall time	(see Figure 16. Test circuit for inductive load switching and diode recovery times and Figure 17. Turn-off switching time waveform on inductive load Figure 5)	-	33	-	ns
$t_{c(off)}$	Crossing time off		-	38	-	ns
$t_{d(i)}$	Current delay time	$V_{DD} = 400\text{ V}$, $I_D = 48\text{ A}$, $R_G = 4.7\text{ }\Omega$, $V_{GS} = 10\text{ V}$	-	47	-	ns
$t_{r(i)}$	Current rise time		-	64	-	ns
$t_{f(v)}$	Voltage fall time	(see Figure 16. Test circuit for inductive load switching and diode recovery times and Figure 18. Turn-on switching time waveform on inductive load)	-	70	-	ns
$t_{c(on)}$	Crossing time on		-	90	-	ns

Table 7. Source-drain diode

Symbol	Parameter	Test conditions	Min.	Typ.	Max.	Unit
$I_{SD}^{(1)}$	Source-drain current		-		95	A
$I_{SDM}^{(2)}$	Source-drain current (pulsed)		-		440	A
$V_{SD}^{(3)}$	Forward on voltage	$I_{SD} = 95\text{ A}, V_{GS} = 0\text{ V}$	-		1.6	V
t_{rr}	Reverse recovery time	$I_{SD} = 95\text{ A}, di/dt = 100\text{ A}/\mu\text{s},$	-	330		ns
Q_{rr}	Reverse recovery charge	$V_{DD} = 100\text{ V}$	-	5.45		μC
I_{RRM}	Reverse recovery current	(see Figure 16. Test circuit for inductive load switching and diode recovery times)	-	30		A
t_{rr}	Reverse recovery time	$I_{SD} = 95\text{ A}, di/dt = 100\text{ A}/\mu\text{s},$	-	465		ns
Q_{rr}	Reverse recovery charge	$V_{DD} = 100\text{ V}, T_J = 150\text{ }^\circ\text{C}$	-	10.85		μC
I_{RRM}	Reverse recovery current	(see Figure 16. Test circuit for inductive load switching and diode recovery times)	-	34		A

1. Referred to TO-247 package.
2. Pulse width is limited by safe operating area.
3. Pulsed: pulse duration = 300 μs , duty cycle 1.5%.

2.1 Electrical characteristics (curves)

Figure 1. Safe operating area

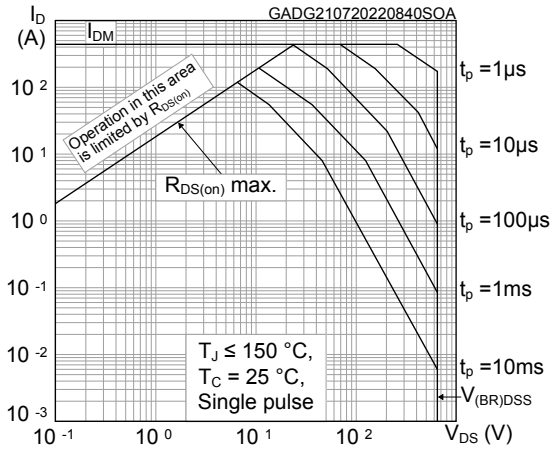

Figure 2. Maximum transient thermal impedance

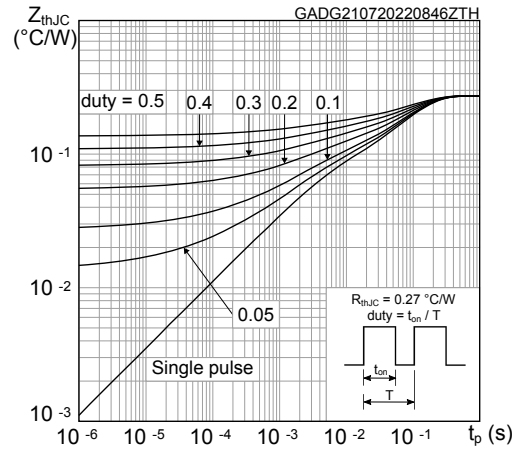

Figure 3. Typical output characteristics

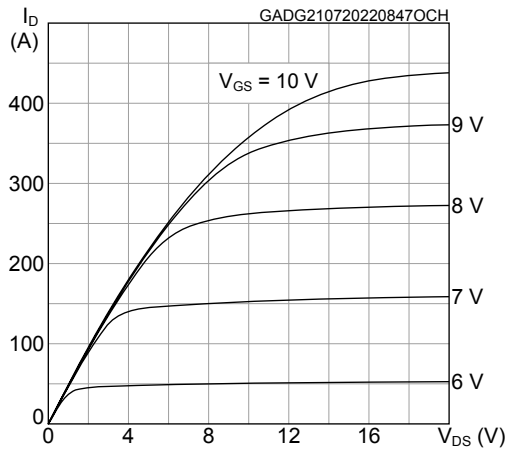

Figure 4. Typical transfer characteristics

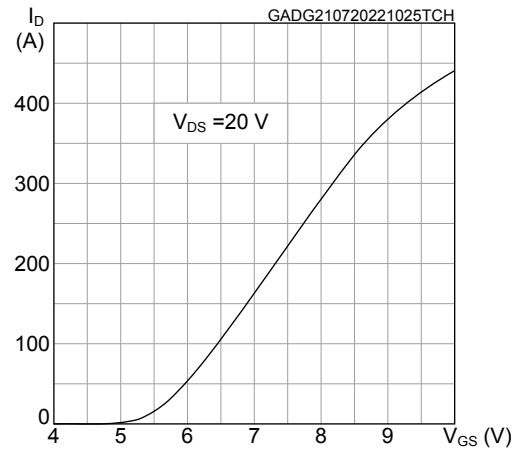

Figure 5. Typical gate charge characteristics

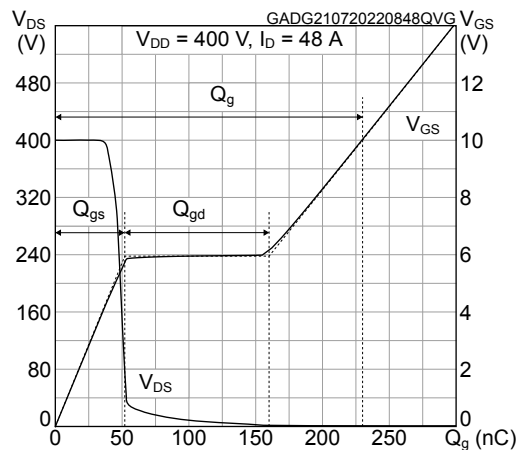

Figure 6. Typical capacitance characteristics

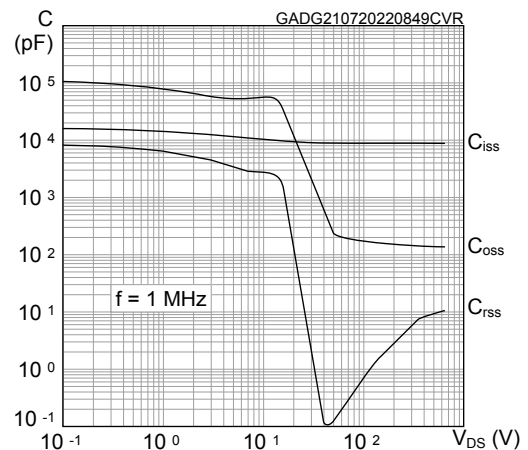

Figure 7. Typical drain-source on-resistance

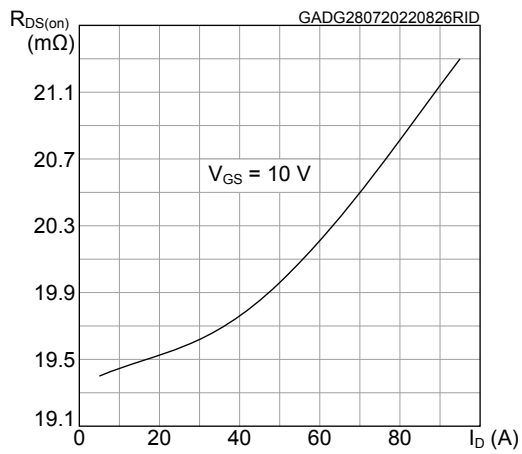

Figure 8. Normalized on-resistance vs temperature

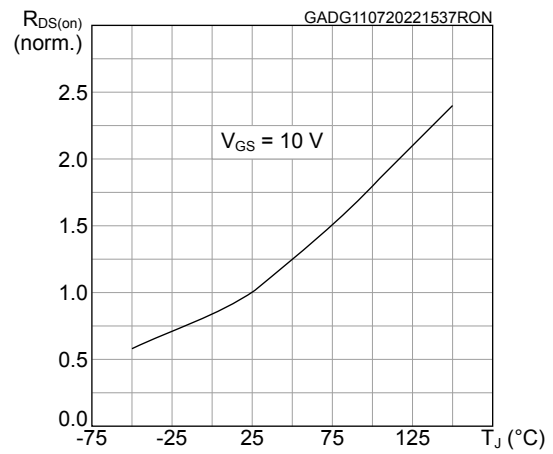

Figure 9. Normalized gate threshold vs temperature

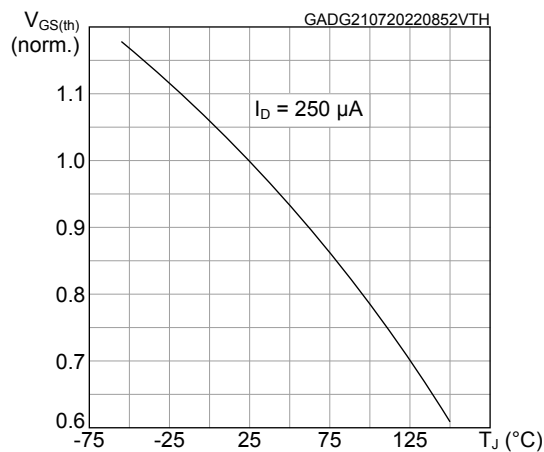

Figure 10. Normalized breakdown voltage vs temperature

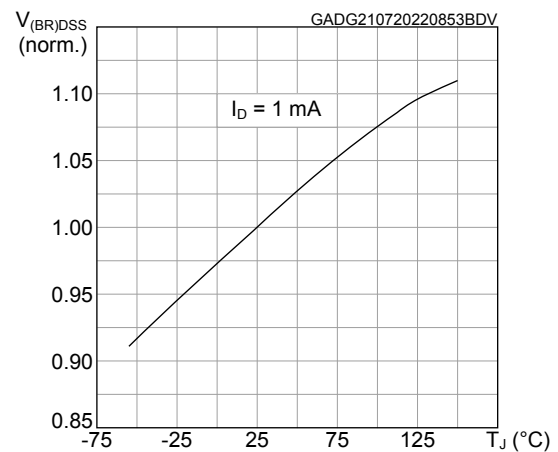

Figure 11. Typical reverse diode forward characteristics

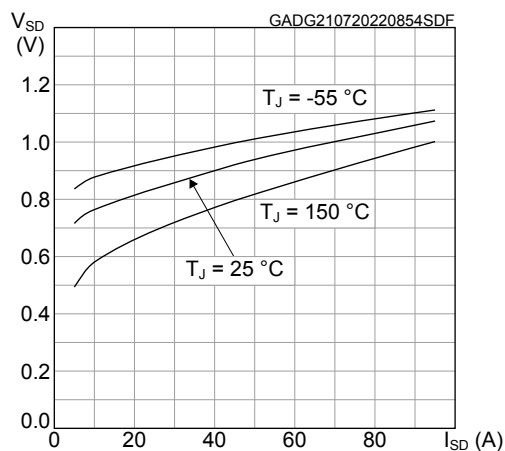
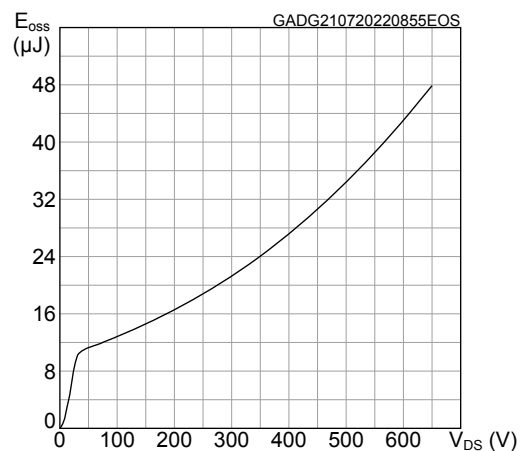
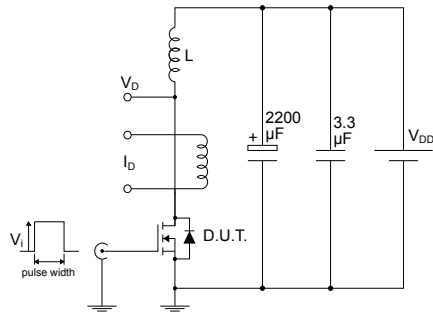

Figure 12. Typical output capacitance stored energy



3 Test circuits

Figure 13. Unclamped inductive load test circuit



AM01471v1

Figure 14. Unclamped inductive waveform

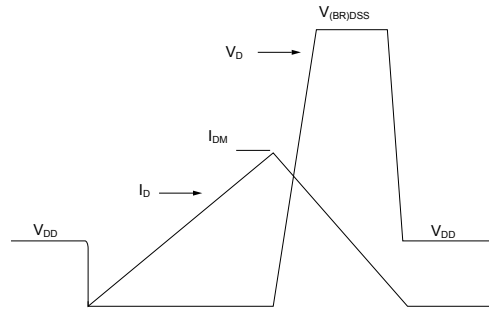

AM01472v1

Figure 15. Test circuit for gate charge behavior

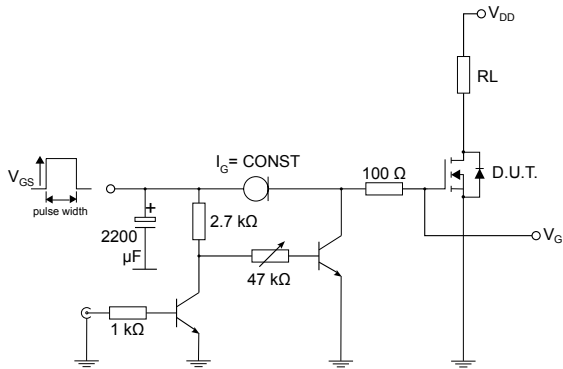

AM01469v10

Figure 16. Test circuit for inductive load switching and diode recovery times

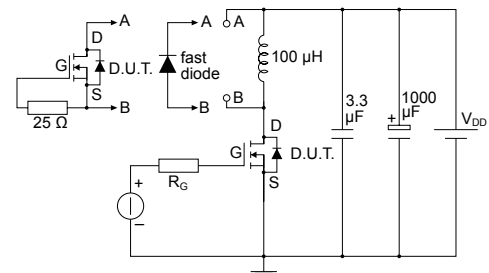

AM01470v1

Figure 17. Turn-off switching time waveform on inductive load

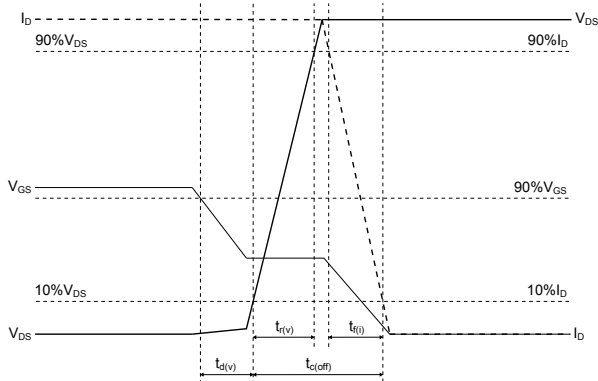

AM05540v3

Figure 18. Turn-on switching time waveform on inductive load

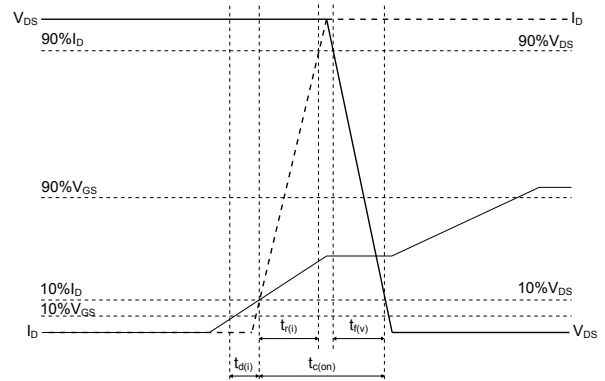

GADG241120211046SWTW

4 Package information

In order to meet environmental requirements, ST offers these devices in different grades of **ECOPACK** packages, depending on their level of environmental compliance. ECOPACK specifications, grade definitions and product status are available at: www.st.com. ECOPACK is an ST trademark.

4.1 TO-247 long leads package information

Figure 19. TO-247 long leads package outline

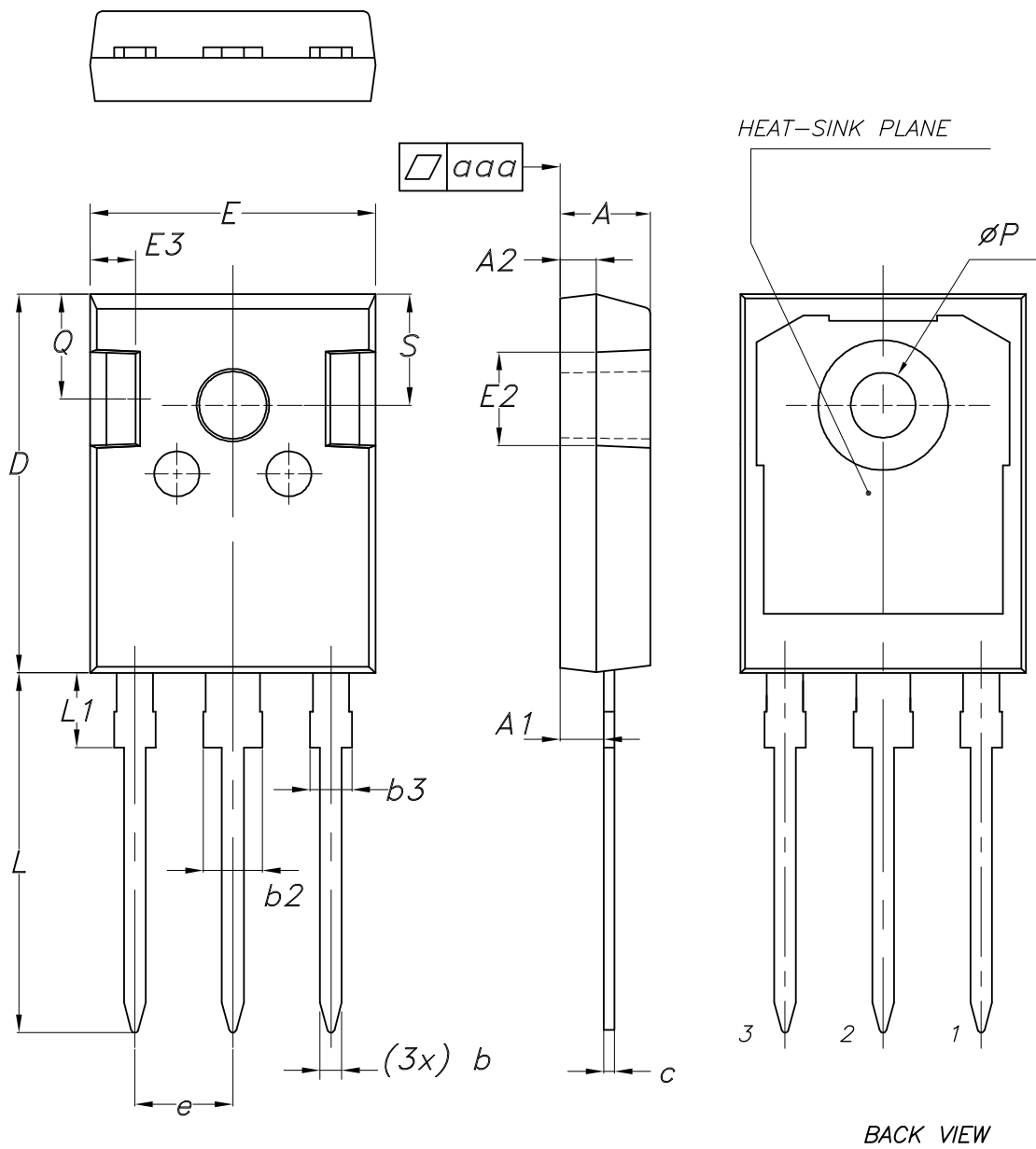

Table 8. TO-247 long leads package mechanical data

Dim.	mm		
	Min.	Typ.	Max.
A	4.90	5.00	5.10
A1	2.31	2.41	2.51
A2	1.90	2.00	2.10
b	1.16		1.26
b2			3.25
b3			2.25
c	0.59		0.66
D	20.90	21.00	21.10
E	15.70	15.80	15.90
E2	4.90	5.00	5.10
E3	2.40	2.50	2.60
e	5.34	5.44	5.54
L	19.80	19.92	20.10
L1			4.30
P	3.50	3.60	3.70
Q	5.60		6.00
S	6.05	6.15	6.25
aaa		0.04	0.10

Revision history

Table 9. Document revision history

Date	Revision	Changes
02-Dec-2022	1	First release.
27-Feb-2023	2	Updated Table 4. On-/off-states.

Contents

1	Electrical ratings	2
2	Electrical characteristics	3
2.1	Electrical characteristics (curves)	5
3	Test circuits	7
4	Package information	8
4.1	TO-247 long leads package information	8
	Revision history	10

IMPORTANT NOTICE – READ CAREFULLY

STMicroelectronics NV and its subsidiaries (“ST”) reserve the right to make changes, corrections, enhancements, modifications, and improvements to ST products and/or to this document at any time without notice. Purchasers should obtain the latest relevant information on ST products before placing orders. ST products are sold pursuant to ST’s terms and conditions of sale in place at the time of order acknowledgment.

Purchasers are solely responsible for the choice, selection, and use of ST products and ST assumes no liability for application assistance or the design of purchasers’ products.

No license, express or implied, to any intellectual property right is granted by ST herein.

Resale of ST products with provisions different from the information set forth herein shall void any warranty granted by ST for such product.

ST and the ST logo are trademarks of ST. For additional information about ST trademarks, refer to www.st.com/trademarks. All other product or service names are the property of their respective owners.

Information in this document supersedes and replaces information previously supplied in any prior versions of this document.

© 2023 STMicroelectronics – All rights reserved